

# CANELA

2011

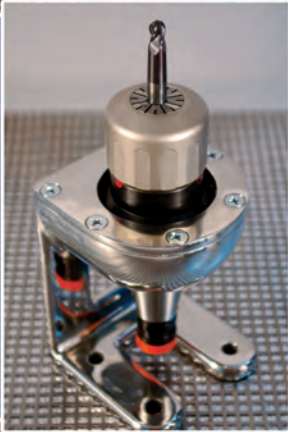

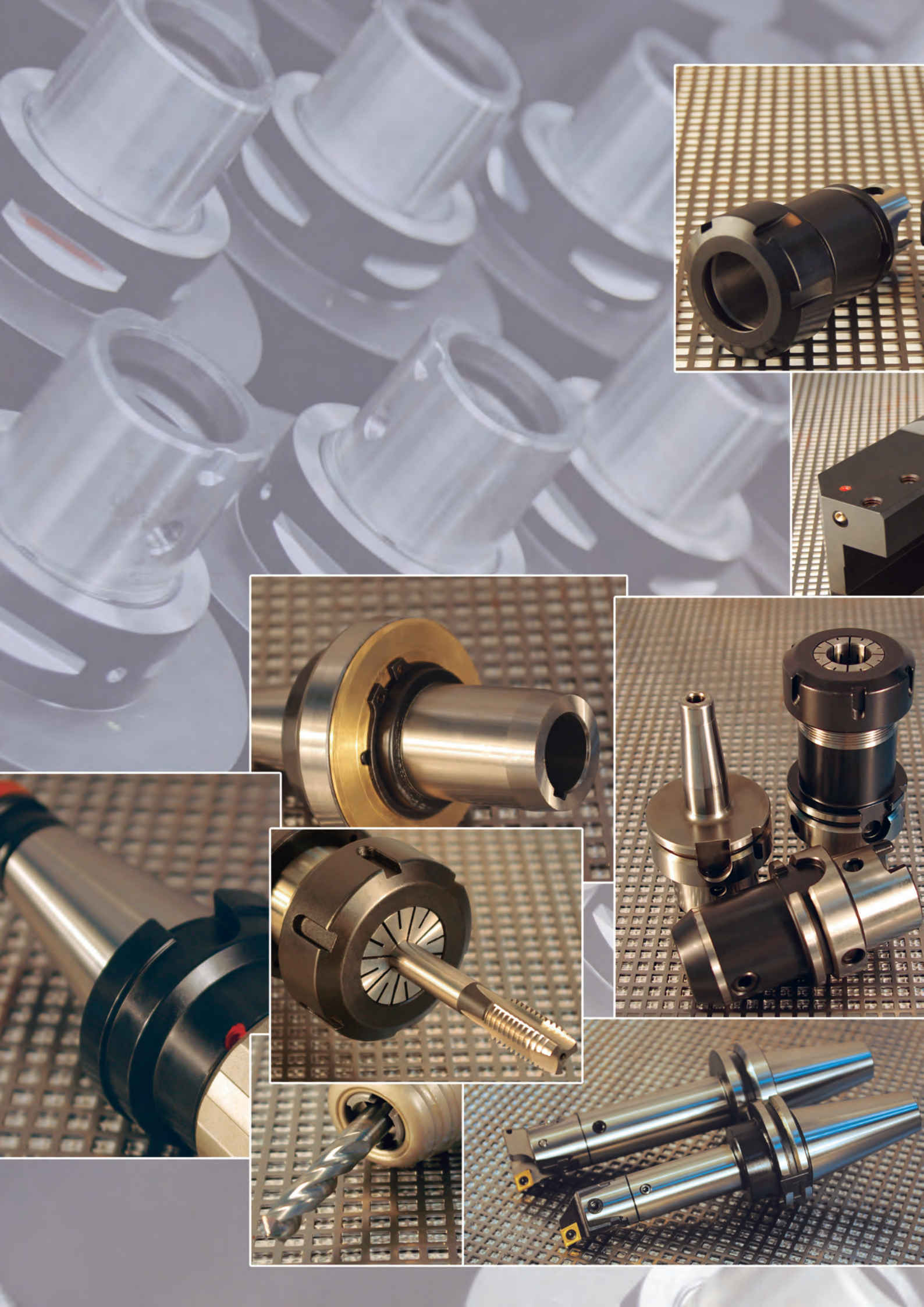







## **Index** *Inhaltsverzeichnis*

Page / Seite A.01

**DIN 2080**



Page / Seite B.01

**DIN 69871-A**



Page / Seite C.01

**HSK DIN 69893-1 FORM A**



Page / Seite D.01

**TS ISO 26622-1**



Page / Seite E.01

**PSC ISO 26623-1**



Page / Seite F.01

**JIS B 6339-BT**



Page / Seite G.01

**CHIRON**



Page / Seite H.01

**BORING HEADS / BOHRKÖPFE**



Page / Seite I.01

**MORSE SHANKS / MORSE SCHÄFTE**



Page / Seite J.01

**CYLINDRICAL SHANKS / ZYLINDRISCHE SCHÄFTE**



Page / Seite K.01

**ACCESSORIES / ZUBEHÖR**



## MANUFACTURED FROM FORGED PARTS

## MATERIAL:

- Alloyed carburized steel at chrome-manganese 1.7131 (16MnCr5).

## EXECUTION:

- Carburized, hardness.  
- Surface hardness HRC 58±2 (670±40 HV30)  
- Depth minimum 0,5 mm.  
- Tensile strength in core minimum 800 N/mm<sup>2</sup> after carburizing.

## ACCURACY:

- Taper according to DIN 254  
- Taper angle:  
tolerance AT 3 DIN 7178 part 1 and DIN 2080 part 1.  
- Other tolerances according to DIN 7160 and 7168.  
- Taper surface roughness R<sub>z</sub><0,001 mm.

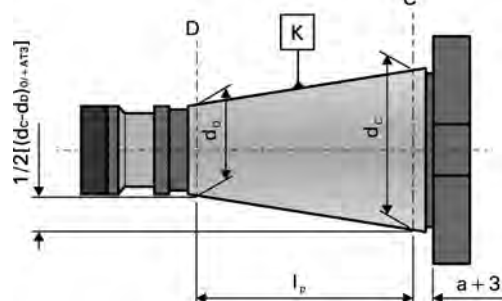

## TOLERANCE AT:

- Indicates the tolerance of size D surface between the real and the theoretical value of the taper conicity.  
- This value of surface D must always be less (negative), never more (positive) in order to GUARANTEE a good toolholder fixation at the bigger taper diameter.

## HERGESTELLT AUS GESCHMIEDETEN TEILEN

## MATERIAL:

- Legierter Aufgekohlter Stahl mit Chrom-Mangan 1.7131 (16MnCr5).

## KONSTRUKTIONSDATEN:

- Aufgekohlt, gehärtet und angelassen.  
- Oberflächenhärte HRC 58±2 (670±40 HV30).  
- Aufgekohlt auf minimum 0,5 mm Tiefe.  
- Zugfestigkeit im Kern minimum 800 N/mm<sup>2</sup> nach der Aufkohlung.

## GENAUIGKEIT:

- Dorn nach DIN 254.  
- Kegelwinkel:  
Toleranz AT 3 DIN 7178 Teil 1 und DIN 2080 Teil 1.  
- Andere Toleranzen entsprechend DIN 7160 und 7168.  
- Rauigkeit der Oberfläche R<sub>z</sub><0,001 mm.

K	AT 3 mm
ISO 30	0,002
ISO 40	0,003
ISO 45	0,003
ISO 50	0,004
ISO 60	0,005

## TOLERANZ AT:

- Zeigt die Toleranz auf der Messebene D zwischen dem tatsächlichen Wert der Kegelkonizität und dem theoretischen Wert.  
- Dieser Wert auf der Messebene D sollte immer minus (negativ) sein, nie plus (positiv), um für einen guten Halt des Futter in den größeren Durchmesser des Kegels zu garantieren.

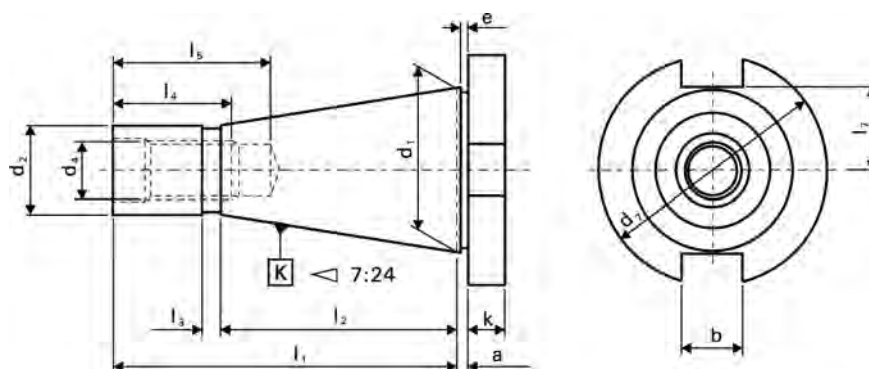

K ISO	a±0,2 mm	b H12 mm	d <sub>1</sub> mm	d <sub>2</sub> mm	d <sub>4</sub> mm	d <sub>7</sub> mm	k mm
30	1,6	16,1	31,75	17,4	M 12	50,0	8
40	1,6	16,1	44,45	25,3	M 16	63,0	10
45	3,2	19,3	57,15	32,4	M 20	80,0	12
50	3,2	25,7	69,85	39,6	M 24	97,5	12
60	3,2	25,7	107,95	60,2	M 30	156,0	16

K ISO	l <sub>1</sub> mm	l <sub>2</sub> mm	l <sub>3</sub> mm	l <sub>4</sub> mm	l <sub>5</sub> min mm	l <sub>7</sub> max mm
30	68,4	48,4	3	24	33,5	16,2
40	93,4	65,4	5	32	42,5	22,5
45	106,8	82,8	6	40	52,5	29,0
50	126,8	101,8	8	47	61,5	35,3

<p><b>10.160</b></p>  <p>A.02</p>	<p><b>10.165</b></p>  <p>A.03</p>	<p><b>10.180</b></p>  <p>A.04</p>	<p><b>10.210</b></p>  <p>A.05</p>	<p><b>10.215</b></p>  <p>A.06</p>
<p><b>10.216</b></p>  <p>A.07</p>	<p><b>10.220</b></p>  <p>A.08</p>	<p><b>10.225</b></p>  <p>A.09</p>	<p><b>10.290</b></p>  <p>A.10</p>	<p><b>10.295</b></p>  <p>A.11</p>
<p><b>10.296</b></p>  <p>A.12</p>	<p><b>10.300</b></p>  <p>A.13</p>	<p><b>10.302</b></p>  <p>A.14</p>	<p><b>10.353</b></p>  <p>A.15</p>	<p><b>10.453</b></p>  <p>A.16</p>
<p><b>10.457</b></p>  <p>A.18</p>	<p><b>10.470</b></p>  <p>A.19</p>	<p><b>10.610</b></p>  <p>A.20</p>	<p><b>10.620</b></p>  <p>A.21</p>	<p><b>10.630</b></p>  <p>A.22</p>
<p><b>SET</b></p>  <p>A.17</p>				

10  
DIN 2080

11 13  
DIN 69871-A

16  
HSK DIN 69893-

17  
TS ISO 26622-1

18  
PSC ISO 26623-1

20 23  
JIS B 6339-BT

25  
CHIRON

BORING HEADS  
BOHRKÖPFE



MORSE SHANKS  
MORSE SCHÄFTE

CYLINDRICAL SHANKS  
ZYLINDRISCHE SCHÄFTE

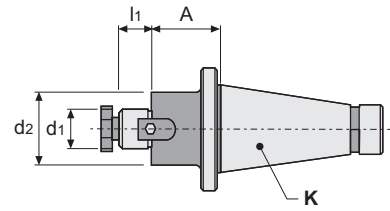
ACCESSORIES  
ZUBEHÖR





REF.	K ISO	d <sub>1</sub> h6 mm	A mm	l <sub>1</sub> mm	d <sub>2</sub> mm	⚖ kg
10.160.30.16	30	16	30	17	38	0,555
10.160.30.22		22	30	19	48	0,715
10.160.30.27		27	30	21	58	0,895
10.160.30.32		32	35	24	78	1,085
10.160.40.16	40	16	30	17	38	1,040
10.160.40.16/100		16	100	17	38	1,480
10.160.40.22		22	30	19	48	1,180
10.160.40.22/100		22	100	19	48	2,200
10.160.40.27		27	30	21	58	1,330
10.160.40.27/100		27	100	21	58	2,810
10.160.40.32		32	35	24	63	1,560
10.160.40.32/125		32	125	24	63	3,410
10.160.40.40		40	40	27	73	1,900
10.160.50.16	50	16	35	17	38	3,070
10.160.50.16/150		16	150	17	38	3,830
10.160.50.22		22	35	19	48	3,360
10.160.50.22/150		22	150	19	48	4,570
10.160.50.27		27	35	21	58	3,300
10.160.50.27/150		27	150	21	58	5,770
10.160.50.32		32	40	24	63	4,000
10.160.50.32/150		32	150	24	63	8,100
10.160.50.40		40	40	27	73	4,360
10.160.50.40/150		40	150	27	73	6,770
10.160.50.50		50	40	30	90	4,650

REF.			
10.160.30.16	10008	86016	11103
10.160.30.22	10010	86022	11004
10.160.30.27	10012	86027	11005
10.160.30.32	10016	86032	11105
10.160.40.16	10008	86016	11103
10.160.40.16/100	10008	86016	11103
10.160.40.22	10010	86022	11004
10.160.40.22/100	10010	86022	11004
10.160.40.27	10012	86027	11005
10.160.40.27/100	10012	86027	11005
10.160.40.32	10016	86032	11105
10.160.40.32/125	10016	86032	11105
10.160.40.40	10020	86040	11006
10.160.50.16	10008	86016	11103
10.160.50.16/150	10008	86016	11103
10.160.50.22	10010	86022	11004
10.160.50.22/150	10010	86022	11004
10.160.50.27	10012	86027	11005
10.160.50.27/150	10012	86027	11005
10.160.50.32	10016	86032	11105
10.160.50.32/150	10016	86032	11105
10.160.50.40	10020	86040	11006
10.160.50.40/150	10020	86040	11006
10.160.50.50	10024	86050	11008

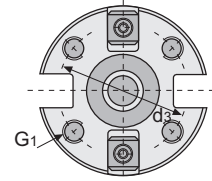
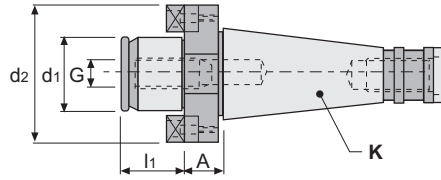



REF.	K ISO	d <sub>1</sub> g5 mm	A mm	d <sub>2</sub> mm	d <sub>3</sub> mm	G mm	G <sub>1</sub> mm	l <sub>1</sub> mm	⚖️ kg
10.165.40.40	40	40	20	89	66,7	M-20	M-12	30	1,650
10.165.50.40	50	40	30	89	66,7	M-20	M-12	30	1,650
10.165.50.60		60	30	129	101,6	M-30	M-16	40	4,920

REF.	2 x 	2 x 
10.165.40.40	80040	11006
10.165.50.40	80040	11006
10.165.50.60	80060	11012

10  
DIN 2080

11 13  
DIN 69871-A

16  
HSK DIN 69833-

17  
TS ISO 26622-1

18  
PSC ISO 26623-1

20 23  
JIS B 6339-BT

25  
CHIRON

BORING HEADS  
BOHRKÖPFE

MORSE SHANKS  
MORSE SCHÄFTE

CYLINDRICAL SHANKS  
ZYLINDRISCHE SCHÄFTE

ACCESSORIES  
ZUBEHÖR

## COMBI-SHELL MILL ADAPTOR

for cutters with keyway or driving slot DIN 138

## KOMBI-AUFSTECKFRÄSDORNE

für Fräser mit Längsnut oder Stirnmitnehmer DIN 138



DIN 2080

DIN 6358- Form A

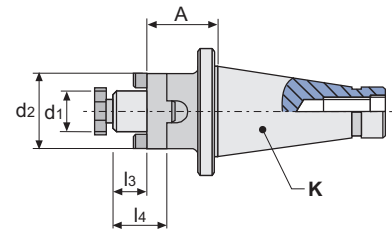
10.180





REF.	K ISO	d <sub>1</sub> h6 mm	A mm	l <sub>3</sub> mm	l <sub>4</sub> mm	d <sub>2</sub> mm	kg
10.180.30.16	30	16	35	17	27	32	0,560
10.180.30.22		22	35	19	31	40	0,690
10.180.30.27		27	35	21	33	48	0,830
10.180.30.32		32	50	24	38	58	1,360
10.180.40.16	40	16	52	17	27	32	1,130
10.180.40.16/125		16	125	17	27	32	1,670
10.180.40.22		22	52	19	31	40	1,310
10.180.40.22/125		22	125	19	31	40	2,250
10.180.40.27		27	52	21	33	48	1,530
10.180.40.27/125		27	125	21	33	48	2,930
10.180.40.32		32	52	24	38	58	1,840
10.180.40.32/125		32	125	24	38	58	3,390
10.180.40.40		40	52	27	41	70	2,430
10.180.50.16	50	16	55	17	27	32	3,120
10.180.50.16/125		16	125	17	27	32	3,650
10.180.50.22		22	55	19	31	40	3,340
10.180.50.22/125		22	125	19	31	40	3,650
10.180.50.22/200		22	200	19	31	40	5,130
10.180.50.27		27	55	21	33	48	3,520
10.180.50.27/125		27	125	21	33	48	4,860
10.180.50.27/200		27	200	21	33	48	6,220
10.180.50.32		32	55	24	38	58	3,830
10.180.50.32/125		32	125	24	38	58	5,980
10.180.50.32/200		32	200	24	38	58	8,280
10.180.50.40		40	55	27	41	70	4,420
10.180.50.40/125		40	125	27	41	70	6,770
10.180.50.50		50	55	30	46	90	4,400

REF.			
.....16..	10008	60116	88016
.....22..	10010	60122	88022
.....27..	10012	60127	88027
.....32..	10016	60132	88032
.....40..	10020	60140	88040
.....50..	10024	60150	88050

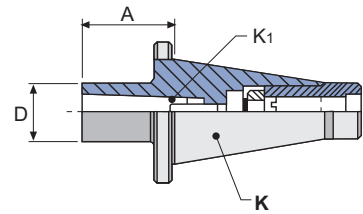



REF.	K ISO	K <sub>1</sub> MORSE	A mm	D mm	⚖️ kg
10.210.30.01	30	1	50	25	0,480
10.210.30.02		2	50	32	0,570
10.210.30.03		3	76	40	0,750
10.210.40.01	40	1	50	25	0,940
10.210.40.02		2	50	32	0,940
10.210.40.03		3	65	40	1,110
10.210.40.04		4	95	48	1,520
10.210.50.01	50	1	60	25	2,940
10.210.50.02		2	60	32	2,960
10.210.50.03		3	65	40	3,020
10.210.50.04		4	65	48	3,070
10.210.50.05		5	100	63	3,540

REF.			
10.210.30.01	16004	19312	11406
10.210.30.02	16005	19315	12110
10.210.30.03	16005	19318	12012
10.210.40.01	16105	19516	11506
10.210.40.02	16205	19416	12110
10.210.40.03	16205	19420	11312
10.210.40.04	16205	19322	12016
10.210.50.01	16205	19624	11206
10.210.50.02	16205	19324	11210
10.210.50.03	16205	19524	11512
10.210.50.04	16205	19424	12016
10.210.50.05	16205	19338	11020

10  
DIN 2080

11 13  
DIN 69871-A

16  
HSK DIN 69833-

17  
TS ISO 26622-1

18  
PSC ISO 26623-1

20 23  
JIS B 6339-BT

25  
CHIRON

BORING HEADS  
BOHRKÖPFE

MORSE SHANKS  
MORSE SCHÄFTE

CYLINDRICAL SHANKS  
ZYLINDRISCHE SCHÄFTE

ACCESSORIES  
ZUBEHÖR

**REDUCING ADAPTORS**

For mounting tools with Morse taper shank and tang according to DIN 228-1 form B

**REDUZIERHÜLSEN**

für Werkzeuge mit Morsekegel und Austreibblappen DIN 228-1 Form B

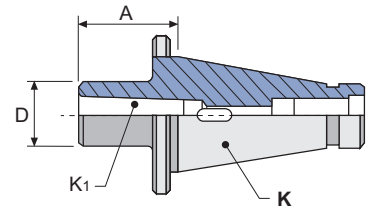
**DIN 2080****DIN 6383  
ISO 4202****10.215**

REF.	K ISO	K <sub>1</sub> MORSE	A mm	D mm	
10.215.30.01	30	1	50	25	0,470
10.215.30.02		2	50	32	0,490
10.215.30.03		3	76	40	0,720
10.215.40.01	40	1	50	25	0,870
10.215.40.02		2	50	32	0,900
10.215.40.03		3	65	40	1,050
10.215.40.04		4	95	48	1,380
10.215.50.01	50	1	45	25	2,790
10.215.50.02		2	60	32	2,890
10.215.50.03		3	65	40	2,920
10.215.50.04		4	70	48	2,940
10.215.50.05		5	105	63	3,370



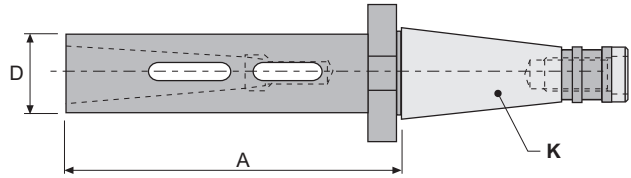

REF.	K ISO	K <sub>1</sub> MORSE	A mm	D mm	Kg
10.216.40.02	40	2	110	32	1,320
10.216.40.03		3	135	40	1,720
10.216.40.04		4	160	48	2,240
10.216.50.02	50	2	115	32	3,290
10.216.50.03		3	140	40	3,740
10.216.50.04		4	165	48	4,270
10.216.50.05		5	215	63	6,000

10  
DIN 2080

11 13  
DIN 69871-A

16  
HSK DIN 69833-

17  
TS ISO 26622-1

18  
PSC ISO 26623-1

20 23  
JIS B 6330-BT

25  
CHIRON

BORING HEADS  
BOHRKÖPFE

MORSE SHANKS  
MORSE SCHÄFTE

CYLINDRICAL SHANKS  
ZYLINDRISCHE SCHÄFTE

ACCESSORIES  
ZUBEHÖR

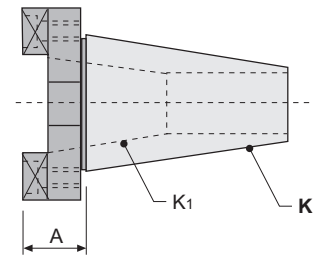

REF.	K ISO	K <sub>1</sub> ISO	A mm	
10.220.40.30	40	30	19	0,740
10.220.50.30	50	30	23	2,580
10.220.50.40		40	23	2,470

REF.	2 x 	2 x 
10.220.40.30	80440	11006
10.220.50.30	80440	11006
10.220.50.40	80440	11006



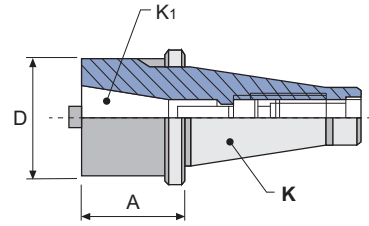

REF.	K ISO	K <sub>1</sub> ISO	A mm	D mm	kg
10.225.40.30	40	30	50	50	1,190
10.225.50.30	50	30	50	50	3,050
10.225.50.40		40	50	63	3,140

REF.			
10.225.40.30	16205	19420	11312
10.225.50.30	16205	19524	11512
10.225.50.40	16205	19424	12016

10  
DIN 2080

11 13  
DIN 69871-A

16  
HSK DIN 69833-

17  
TS ISO 26622-1

18  
PSC ISO 26623-1

20 23  
JIS B 6339-BT

25  
CHIRON

BORING HEADS  
BOHRKÖPFE

MORSE SHANKS  
MORSE SCHÄFTE

CYLINDRICAL SHANKS  
ZYLINDRISCHE SCHÄFTE

ACCESSORIES  
ZUBEHÖR

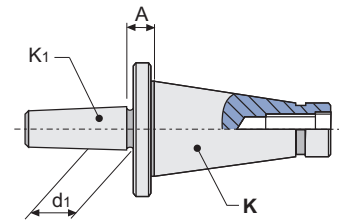

REF.	K ISO	K <sub>1</sub> DIN 238	A mm	d <sub>1</sub> mm	
10.290.30.12	30	B-12	15	12,065	0,390
10.290.30.16		B-16	15	15,733	0,380
10.290.30.18		B-18	15	17,437	-
10.290.40.12	40	B-12	17	12,065	0,860
10.290.40.16		B-16	17	15,733	0,880
10.290.40.18		B-18	17	17,437	0,890
10.290.50.16	50	B-16	20	15,733	2,880
10.290.50.18		B-18	20	17,437	2,920

REF.	ACCESSORIES / ZUBEHÖR
MU	Standard keyless drill chucks DIN 238 / Standard Schnellspann-Bohrfutter DIN 238
MP	Precision keyless drill chucks DIN 238 / Schnellspann-Bohrfutter DIN 238, Genauigkeitsausführung
MK	Self clamping precision keyless drill chucks DIN 238 / Selbstspann-Bohrfutter DIN 238, Genauigkeitsausführung
MH	CNC-UNIVERSAL precision drill chucks DIN 238 / CNC-Universaler Bohrfutter DIN 238, Genauigkeitsausführung



MU



MP



MK



MH



For more information see page / Für weitere Informationen siehe Seite: K.02, K.03, K.04, K.05

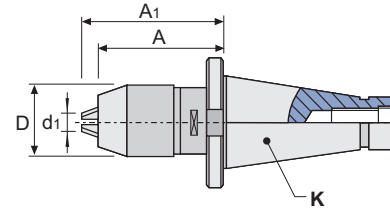



REF.	K ISO	d <sub>1</sub> mm	D mm	A mm	A <sub>1</sub> max mm	⚖️ Kg
10.295.30.08	30	0-08	36,0	66,0	74,5	0,930
10.295.40.08	40	0-08	36,0	60,0	68,0	1,100
10.295.40.13		0-13	50,5	86,5	97,5	1,640
10.295.40.16		3-16	56,0	94,0	107,0	-
10.295.50.13	50	0-13	50,5	81,0	92,0	3,530
10.295.50.16		3-16	56,0	86,0	99,0	3,640

\* SUPPLIED WITH WRENCH / \* GELIEFERT MIT SCHLÜSSEL

REF.			3 x 
10.295.30.08	50008	11206	60308
10.295.40.08	50008	11206	60308
10.295.40.13	50013	11108	60313
10.295.40.16	50016	11108	60313
10.295.50.13	50013	11108	60313
10.295.50.16	50016	11108	60313

10  
DIN 2080

11 13  
DIN 69871-A

16  
HSK DIN 69893-

17  
TS ISO 26622-1

18  
PSC ISO 26623-1

20 23  
JIS B 6339-BT

25  
CHIRON

BORING HEADS  
BOHRKÖPFE

MORSE SHANKS  
MORSE SCHÄFTE

CYLINDRICAL SHANKS  
ZYLINDRISCHE SCHÄFTE

ACCESSORIES  
ZUBEHÖR

**CNC-UNIVERSAL PRECISION DRILL CHUCKS**

for left and right and turn

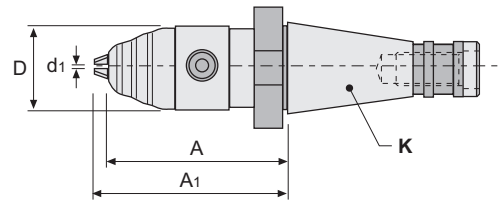

**UNIVERSALER CNC-BOHRFUTTER, GENAUIGKEITSAUSFÜHRUNG**

für links- und rechtslaufende Bearbeitungen



**DIN 2080****10.296**

REF.	K ISO	d <sub>1</sub> mm	D mm	A mm	A <sub>1</sub> max mm	
10.296.30.13	30	1-13	50	74	81	
10.296.40.13	40	1-13	50	74	81	1,500
10.296.40.16		3-16	56	83	90	1,770
10.296.50.13	50	1-13	50	78	85	3,520
10.296.50.16		3-16	56	87	94	3,800

\* SUPPLIED WITH WRENCH / \* GELIEFERT MIT SCHLÜSSEL

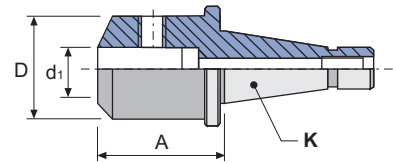
REF.		3 x 
10.296.30.13	50706	60313
10.296.40.13	50706	60313
10.296.40.16	50706	60313
10.296.50.13	50706	60313
10.296.50.16	50706	60313



REF.	K ISO	d1 H4 mm	A mm	D mm		 kg	
10.300.30.06	30	6	40	25	15106	0,410	
10.300.30.08		8	40	28	15108	0,430	
10.300.30.10		10	40	35	15110	0,500	
10.300.30.12		12	40	42	15212	0,560	
10.300.30.14		14	40	44	15212	0,580	
10.300.30.16		16	50	48	15314	0,750	
10.300.30.18	18	50	50	15314	0,760		
10.300.40.06	40	6	50	25	15106	0,880	
10.300.40.08		8	50	28	15108	0,950	
10.300.40.10		10	50	35	15110	1,010	
10.300.40.12		12	50	42	15212	1,110	
10.300.40.14		14	63	44	15212	1,290	
10.300.40.16		16	63	48	15314	1,370	
10.300.40.18		18	63	50	15314	1,400	
10.300.40.20		20	63	52	15216	1,410	
10.300.40.25		25	80	65	2 x 15218	2,180	
10.300.40.32		32	80	72	2 x 15220	2,550	
10.300.40.40		40	102	90	2 x 15220	4,120	
10.300.50.06		50	6	63	25	15106	2,850
10.300.50.08			8	63	28	15108	2,890
10.300.50.10			10	63	35	15110	2,940
10.300.50.12	12		63	42	15212	3,140	
10.300.50.14	14		63	44	15212	3,130	
10.300.50.16	16		63	48	15314	3,180	
10.300.50.18	18		63	50	15314	3,220	
10.300.50.20	20		63	52	15216	3,270	
10.300.50.25	25		80	65	2 x 15218	3,980	
10.300.50.32	32		80	72	2 x 15220	4,210	
10.300.50.40	40		90	90	2 x 15220	5,310	
10.300.50.50	50		100	98	2 x 15024	6,060	

REF.	ACCESSORIES / ZUBEHÖR
42.300	Short and long reducing bushings DIN 1835-B Form A and B / Kurze und lange Reduzierhülsen DIN 1835-B Form A und B
42.311	Short and long reducing bushings DIN 1835-B Form C / Kurze und lange Reduzierhülsen DIN 1835-B Form C



42.300



42.311

For more information see page / Für weitere Informationen siehe Seite: J.11, J.12

10  
DIN 2080

11 13  
DIN 69871-A

16  
HSK DIN 69893-

17  
TS ISO 26622-1

18  
PSC ISO 26623-1

20 23  
JIS B 6339-BT

25  
CHIRON

BORING HEADS  
BOHRKÖPFE

MORSE SHANKS  
MORSE SCHÄFTE

CYLINDRICAL SHANKS  
ZYLINDRISCHE SCHÄFTE

ACCESSORIES  
ZUBEHÖR



## SHORT END MILL ADAPTORS

for cutters and tooling with cylindrical shank and weldon flat DIN 1835-B



## KURZE AUFSTECKFRÄSDORNE

für Fräser und Werkzeuge mit zylindrischem Schaft und Weldon-Fläche DIN 1835-B

DIN 2080

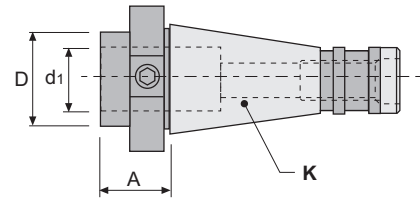
10.302



REF.	K ISO	d <sub>1</sub> H4 mm	A mm	D mm		
10.302.30.16	30	16	20	32	15114	0,400
10.302.30.20		20	34	36	15014	0,390
10.302.40.16	40	16	22	44	15214	0,850
10.302.40.20		20	22	44	15116	0,800
10.302.40.25		25	22	44	15016	0,710
10.302.50.16	50	16	16	-	15314	2,710
10.302.50.20		20	16	-	15216	2,640
10.302.50.25		25	16	-	15118 + 15218	2,540
10.302.50.32		32	16	-	15020 + 15120	2,330

REF.	ACCESSORIES / ZUBEHÖR
42.610	Tapping head with axial compensation DIN 1835-B / Gewindefutter, mit Längenausgleich DIN 1835-B
42.620	Quick change tapping head with axial compensation DIN 1835-B+E / Gewindefutter-Schnellwechselfutter mit Längenausgleich DIN 1835-B + E







42.610

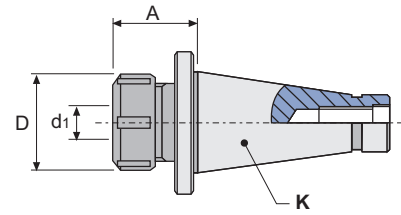

42.620

For more information see page / Für weitere Informationen siehe Seite: J.14, J.15



REF.	K ISO	A mm	d <sub>1</sub> mm	D mm				
10.353.30.16	30	43	2-16	43	43316	50116	19216	0,490
10.353.30.25		70	3-25	60	43325	50125	19216	0,880
10.353.40.16	40	50	2-16	43	43316	50116	19216	0,970
10.353.40.25		63	3-25	60	43325	50125	19224	1,200
10.353.40.32		90	4-32	72	43332	50132	19224	1,840
10.353.50.25	50	63	3-25	60	43325	50125	19224	-
10.353.50.32		70	4-32	72	43332	50132	19230	3,330

*\* If you want with ball bearing nut, see page: K.22*  
*\* Wenn Sie diese mit Kugellager-Nute möchten, siehe Seite: K.22*

**\* SUPPLIED WITHOUT WRENCH / \* GELIEFERT OHNE SCHLÜSSEL**

REF.	ACCESSORIES / ZUBEHÖR
BXX	Collets double slot DIN 6388 - Form B / Spannzangen mit Doppelnut DIN 6388 - Form B



**BXX**

For more information see page / Für weitere Informationen siehe Seite: K.10

10  
DIN 2080

11 13  
DIN 69871-A

16  
HSK DIN 69833-

17  
TS ISO 26622-1

18  
PSC ISO 26623-1

20 23  
JIS B 6339-BT

25  
CHIRON

BORING HEADS  
BOHRKÖPFE

MORSE SHANKS  
MORSE SCHÄFTE

CYLINDRICAL SHANKS  
ZYLINDRISCHE SCHÄFTE

ACCESSORIES  
ZUBEHÖR

## COLLET CHUCKS FOR DIN 6499 (ER) COLLETS

for tools with cylindrical shank





SPANNZANGENFUTTER FÜR SPANNZANGEN DIN 6499 (ER)

für Werkzeuge mit zylindrischem Schaft

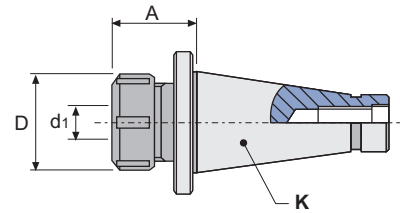
DIN 2080

10.453



REF.	K ISO		A mm	d <sub>1</sub> mm	D mm	D <sub>1</sub> mm				
10.453.30.16	30	ER16	35	0,5-10	32	-	45316	50216	19210	-
10.453.30.20		ER20	38	1-13	35	-	45320	50220	19212	-
10.453.30.25		ER25	42	1-16	42	-	45325	50225	19216	0,480
10.453.30.32		ER32	50	2-20	50	-	45332	50232	19218	0,520
10.453.40.25	40	ER25	44	1-16	42	-	45325	50225	19216	0,920
10.453.40.32		ER32	48	2-20	50	-	45332	50232	19218	0,950
10.453.40.32/070		ER32	70	2-20	50	-	45332	50232	19218	1,140
10.453.40.32/100		ER32	100	2-20	50	50	45332	50232	19218	-
10.453.40.32/150		ER32	150	2-20	50	50	45332	50232	19218	2,050
10.453.40.40		ER40	51	3-30	63	-	45340	50240	19224	1,070
10.453.40.40/100		ER40	100	3-30	63	63	45340	50240	19224	-
10.453.50.25	50	ER25	46	1-16	42	-	45325	50225	19216	2,870
10.453.50.25/150		ER25	150	1-16	42	42	45325	50225	19216	3,600
10.453.50.32		ER32	60	2-20	50	-	45332	50232	19218	2,960
10.453.50.32/100		ER32	100	2-20	50	50	45332	50232	19218	-
10.453.50.32/150		ER32	150	2-20	50	50	45332	50232	19218	3,920
10.453.50.40		ER40	60	3-30	63	-	45340	50240	19224	3,120
10.453.50.40/150		ER40	150	3-30	63	63	45340	50240	19224	4,530
10.453.50.50		ER50	65	6-34	78	-	45350	50250	19230	3,270

\* If you want with ball bearing nut, see page: K.22  
\* Wenn Sie diese mit Kugellager-Nute möchten, siehe Seite: K.22

\* SUPPLIED WITHOUT WRENCH / \* GELIEFERT OHNE SCHLÜSSEL

REF.	ACCESSORIES / ZUBEHÖR
ERXX	Collets double slot DIN 6499 - Form B (ER) / Spannanzgen mit Doppelnut DIN 6499 - Form B (ER)
ERCXX	Sealed collets DIN 6499 (ER) / Abgedichtete Spannanzgen DIN 6499 (ER)
ERTXX	Collets DIN 6499 - Form Canela (ER) / Spannanzgen DIN 6499 - Form Canela (ER)
40.453..	Collet chucks for DIN 6499 (ER) collets / Spannanzgenfutter für DIN 6499 (ER) Spannanzgen
40.455..	Long collet chucks for DIN 6499 (ER) collets / Lange Spannanzgenfutter für DIN 6499 (ER) Spannanzgen



ERXX



ERCXX



ERTXX





40.453..



40.455..

For more information see page / Für weitere Informationen siehe Seite: K.13, K.17, K.19, J.08, J.09



REF.		K ISO		n° 	
SET-10.30.16	DIN 2080	30	ER16	10 (1-10)	-
SET-10.30.20	DIN 2080	30	ER20	12 (2-13)	-
SET-10.30.25	DIN 2080	30	ER25	15 (2-16)	-
SET-10.30.32	DIN 2080	30	ER32	18 (3-20)	-
SET-10.30.40	DIN 2080	30	ER40	23 (4-26)	-
SET-10.40.32	DIN 2080	40	ER32	18 (3-20)	-
SET-10.40.40	DIN 2080	40	ER40	23 (4-26)	-
SET-10.50.32	DIN 2080	50	ER32	18 (3-20)	-
SET-10.50.40	DIN 2080	50	ER40	23 (4-26)	-

10  
DIN 2080

11 13  
DIN 69871-A

16  
HSK DIN 69893-

17  
TS ISO 26622-1

18  
PSC ISO 26623-1

20 23  
JIS B 6339-BT

25  
CHIRON

BORING HEADS  
BOHRKÖPFE





MORSE SHANKS  
MORSE SCHÄFTE

CYLINDRICAL SHANKS  
ZYLINDRISCHE SCHÄFTE

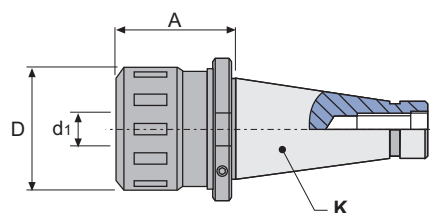
ACCESSORIES  
ZUBEHÖR





REF.	K ISO		d <sub>1</sub> mm	A mm	D mm				
10.457.40.32	40	ER32	2-20	80	54	45732	50704	19006	1,620
10.457.50.32	50	ER32	2-20	85	54	45732	50704	19006	3,630
10.457.50.40		ER40	3-30	97	65	45740	50706	19010	4,570

The alternative to hydraulic or other systems.  
High tightening and precision.  
Central coolant supply.

Die Alternative zu hydraulischen und anderen Systemen.  
Hohes Anzugsmoment und hohe Genauigkeit.  
Kühlmittel durch die Mitte.

\* SUPPLIED WITH WRENCH / \* GELIEFERT MIT SCHLÜSSEL

REF.	ACCESSORIES / ZUBEHÖR
ERXX	Collets double slot DIN 6499 - Form B (ER) / Spannzangen mit Doppelnut DIN 6499 - Form B (ER)
ERCXX	Sealed collets DIN 6499 (ER) / Abgedichtete Spannzangen DIN 6499 (ER)



ERXX



ERCXX

For more information see page / Für weitere Informationen siehe Seite: K.13, K.17

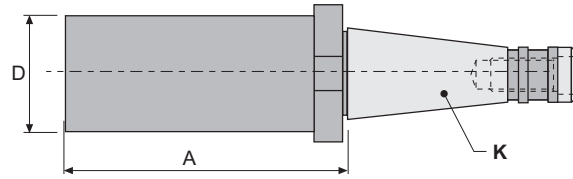

REF.	K ISO	D mm	A mm	kg
10.470.30.40	30	40,5	160	1,920
10.470.40.40	40	40,5	100	1,760
10.470.40.40/160		40,5	160	2,370
10.470.40.50		50,5	100	2,240
10.470.40.50/200		50,5	200	3,820
10.470.40.63		63,5	160	4,530
10.470.40.63/250		63,5	250	6,760
10.470.50.40	50	40,5	100	3,660
10.470.50.40/160		40,5	160	4,300
10.470.50.50		50,5	100	4,250
10.470.50.50/200		50,5	200	5,780
10.470.50.63		63,5	200	7,430
10.470.50.63/315		63,5	315	10,110
10.470.50.95		95,5	200	13,230
10.470.50.95/315		95,5	315	-

10  
DIN 2080

11 13  
DIN 69871-A

16  
HSK DIN 69833-

17  
TS ISO 26622-1

18  
PSC ISO 26623-1

20 23  
JIS B 6339-BT

25  
CHIRON

BORING HEADS  
BOHRKÖPFE

MORSE SHANKS  
MORSE SCHÄFTE

CYLINDRICAL SHANKS  
ZYLINDRISCHE SCHÄFTE

ACCESSORIES  
ZUBEHÖR

## TAPPING HEAD WITH AXIAL COMPENSATION

hold tape with DIN 6499 (ER) collets and with inner coolant





## GEWINDESCHNEIDFUTTER MIT LÄNGENAUSGLEICH

Befestigung mit Spannzangen 6499 (ER), und mit Innenkühlung

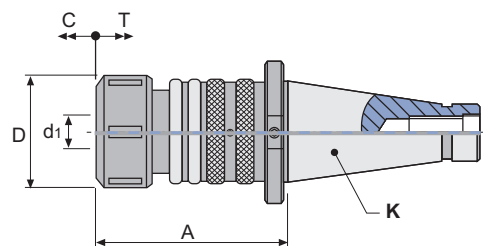
DIN 2080

10.610



REF.	K ISO			d <sub>1</sub>	A mm	D mm	C mm	T mm			
10.610.30.16	30	ER16	M3-M12		100,5	28	5,5	6,0	45316	50216	-
10.610.40.16	40	ER16	M3-M12		88,5	28	5,5	6,0	45316	50216	-
10.610.40.25		ER25	M4-M20		112,0	42	10,5	7,5	45325	50225	-
10.610.40.40		ER40	M8-M33		128,0	63	10,0	10,0	45340	50240	-
10.610.50.16	50	ER16	M3-M12		82,5	28	5,5	6,0	45316	50216	-
10.610.50.25		ER25	M4-M20		106,0	42	10,5	7,5	45325	50225	-
10.610.50.40		ER40	M8-M33		122,0	63	10,0	10,0	45340	50240	-

Compensation in compression (C) and tension (T).

Compression can be blocked by turning the rear ring (A).

Control of threading depth.

Central coolant supply.

Ausgleich der Kompression (C) und der Traktion (T).

Die Kompression kann mit dem Ring (A) blockiert werden.

Kontrolle der Gewindetiefe.

Kühlmittel durch die Mitte.

\* SUPPLIED WITH WRENCH / \* GELIEFERT MIT SCHLÜSSEL

REF.	ACCESSORIES / ZUBEHÖR
ERXX	Collets double slot DIN 6499 - Form B (ER) / Spannzangen mit Doppelnut DIN 6499 - Form B (ER)
ERCXX	Sealed collets DIN 6499 (ER) / Abgedichtete Spannzangen DIN 6499 (ER)
ERTXX	Collets DIN 6499 - Form Canela (ER) / Spannzangen DIN 6499 - Form Canela (ER)
40.453..	Collet chucks for DIN 6499 (ER) collets / Spannzangenfutter für DIN 6499 (ER) Spannzangen
40.455..	Long collet chucks for DIN 6499 (ER) collets / Lange Spannzangenfutter für DIN 6499 (ER) Spannzangen



ERXX



ERCXX



ERTXX







40.453..

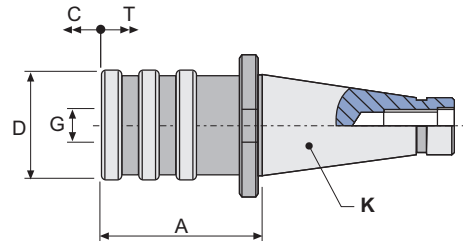

40.455..

For more information see page / Für weitere Informationen siehe Seite: K.13, K.17, K.19, J.08, J.09



REF.	K ISO	G No. Ø		A mm	D mm	C mm	T mm			
10.620.30.12	30	1 19	M3-M12	41	38	9	9	710XX	750XX	0,580
10.620.40.12	40	1 19	M3-M12	41	38	9	9	710XX	750XX	-
10.620.40.20		2 31	M8-M20	63	55	15	15	720XX	760XX	1,460
10.620.40.33		3 48	M14-M33	97	79	24	24	730XX	770XX	-
10.620.50.12	50	1 19	M3-M12	41	38	9	9	710XX	750XX	-
10.620.50.20		2 31	M8-M20	20	55	15	15	720XX	760XX	3,380
10.620.50.33		3 48	M14-M33	97	79	24	24	730XX	770XX	5,090

COMPENSATION IN COMPRESSION (C) AND TENSION (T)  
 AUSGLEICH DER KOMPRESSIION (C) UND DER TRAKTION (T)

REF.	ACCESSORIES / ZUBEHÖR
710XX..730XX	Quick change adpaters without overload clutch / Schnellwechseleinsätze ohne Sicherheitskupplung
750XX..770XX	Quick change adpaters with overload clutch / Schnellwechseleinsätze mit Sicherheitskupplung



710XX..730XX



750XX..770XX

For more information see page / Für weitere Informationen siehe Seite: K.06, K.07

10  
DIN 2080

11 13  
DIN 69871-A

16  
HSK DIN 69833-

17  
TS ISO 26622-1

18  
PSC ISO 26623-1

20 23  
JIS B 6339-BT

25  
CHIRON

BORING HEADS  
BOHRKÖPFE





MORSE SHANKS  
MORSE SCHÄFTE

CYLINDRICAL SHANKS  
ZYLINDRISCHE SCHÄFTE

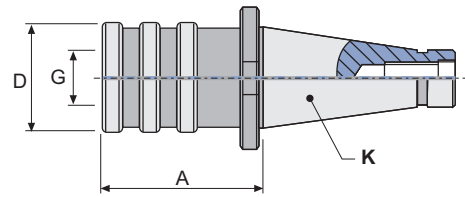
ACCESSORIES  
ZUBEHÖR





REF.	K ISO	G No. Ø		A mm	D mm			
10.630.30.12	30	1 19	M3-M12	50	33	710XX	750XX	-
10.630.40.12	40	1 19	M3-M12	52	33	710XX	750XX	-
10.630.40.20		2 31	M8-M20	74	50	720XX	760XX	-
10.630.40.33		3 48	M14-M33	115	72	730XX	770XX	-
10.630.50.12	50	1 19	M3-M12	55	33	710XX	750XX	-
10.630.50.20		2 31	M8-M20	78	50	720XX	760XX	-
10.630.50.33		3 48	M14-M33	83	72	730XX	770XX	-

WITH INNER COOLANT  
MIT INNENKÜHLUNG

REF.	ACCESSORIES / ZUBEHÖR
710XX..730XX	Quick change adapters without overload clutch / Schnellwechseleinsätze ohne Sicherheitskupplung
750XX..770XX	Quick change adapters with overload clutch / Schnellwechseleinsätze mit Sicherheitskupplung



710XX..730XX



750XX..770XX

For more information see page / Für weitere Informationen siehe Seite: K.06, K.07

**1** TYPE / TYP

10.160 	10.165 	10.180 	10.210 	10.215 
10.216 	10.220 	10.225 	10.290 	10.295 
10.296 	10.300 	10.302 	10.353 	10.453 
10.457 	10.470 	10.610 	10.620 	10.630 

**2** DIMENSION / ABMESSUNG

<b>30</b>	<b>35</b>	<b>40</b>	<b>45</b>	<b>50</b>	<b>60</b>
-----------	-----------	-----------	-----------	-----------	-----------

**3** LENGTH (A) / LÄNGE (A)



A

---

---

---

---

---

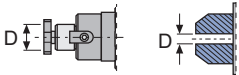
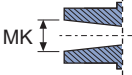
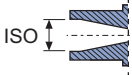
DIAMETER / DURCHMESSER	MK	ISO	COLLET SPANNZANGE
			

NOTES:

---

---

---

---

---

10 DIN 2080  
 11 13 DIN 69871-A  
 16 HSK DIN 69833-1  
 17 TS ISO 26622-1  
 18 PSC ISO 26623-1  
 20 23 JIS B 6339-BT  
 25 CHIRON  
 BORING HEADS  
 BOHRKÖPFE  
 MORSE SHANKS  
 MORSE SCHÄFTE  
 CYLINDRICAL SHANKS  
 ZYLINDRISCHE SCHÄFTE  
 ACCESSORIES  
 ZUBEHÖR

## MANUFACTURED FROM FORGED PARTS

## MATERIAL:

- Alloyed carburized steel at chrome-manganese 1.7131 (16MnCr5).

## EXECUTION:

- Carburized, hardness.  
- Surface hardness HRC 58±2 (670±40 HV30)  
- Depth minimum 0,5 mm.  
- Tensile strength in core minimum 800 N/mm<sup>2</sup> after carburizing.

## ACCURACY:

- Taper according to DIN 254  
- Taper angle:  
tolerance AT 3 DIN 7178 part 1 and DIN 2080 part 1.  
- Other tolerances according to DIN 7160 and 7168.  
- Taper surface roughness  $R_z < 0,001$  mm.

K	AT 3 mm
ISO 30	0,002
ISO 40	0,003
ISO 45	0,003
ISO 50	0,004
ISO 60	0,005

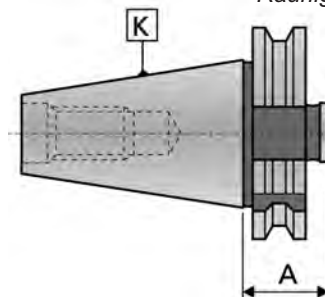
PREBALANCED  
TOOLHOLDERSVORGEWUCHTETE  
WERKZEUGHALTER

ISO 40 ▶ 8000 rpm ISO 50 ▶ 8000 rpm



## TOLERANCE AT:

- Indicates the tolerance of size D surface between the real and the theoretical value of the taper conicity.  
- This value of surface D must always be less (negative), never more (positive) in order to GUARANTEE a good toolholder fixation at the bigger taper diameter.

## TOLERANZ AT:

- Zeigt die Toleranz auf der Messebene D zwischen dem tatsächlichen Wert der Kegelonizität und dem theoretischen Wert.  
- Dieser Wert auf der Messebene D sollte immer minus (negativ) sein, nie plus (positiv), um für einen guten Halt des Futters in den größeren Durchmesser des Kegels zu garantieren.

## 11 DIN 69871-A-AD

FORM A : SIMILAR DIN 69871 AD  
ÄHNLICH WIE DIN 69871 AD

WITHOUT THROUGH HOLE  
OHNE DURCHGANGSLOCH

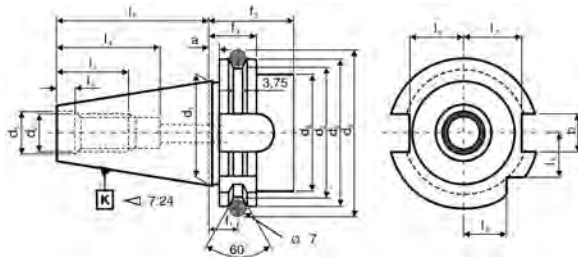

## 13 DIN 69871-B

FORM B : SIMILAR DIN 69871 AD+B  
ÄHNLICH WIE DIN 69871 AD+B

WITH CENTRAL COOLANT FEED THROUGH THE COLLAR  
MIT ZENTRALEM KÜHLMITTELZUFUHR DURCH DEM BUND

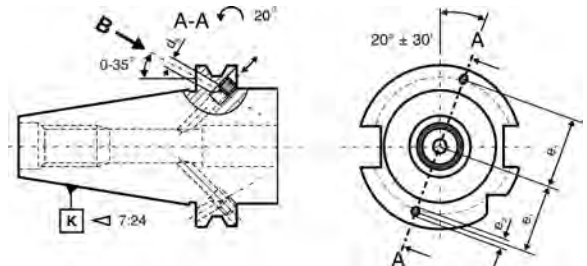

K ISO	a±0,1 mm	b H12 mm	d <sub>1</sub> mm	d <sub>2</sub> mm	d <sub>3</sub> H7 mm	d <sub>5</sub> ±0,5 mm	d <sub>6</sub> 0/-0,1 mm	d <sub>7</sub> 0/-0,5 mm	d <sub>8</sub> max mm
30	3,2	16,1	31,75	M 12	13	59,30	50,00	44,30	45
40	3,2	16,1	44,45	M 16	17	72,30	63,55	56,25	50
50	3,2	25,7	69,85	M 24	25	107,25	97,50	91,25	80
60	3,2	25,7	107,95	M 30	32	164,75	155,00	147,70	130





K ISO	f <sub>1</sub> ±0,1 mm	f <sub>2</sub> min mm	f <sub>3</sub> 0/-0,1 mm	l <sub>1</sub> mm	l <sub>2</sub> mm	l <sub>3</sub> min mm	l <sub>4</sub> min mm	l <sub>5</sub> 0/-0,3 mm	l <sub>6</sub> 0/-0,4 mm	l <sub>7</sub> 0/-0,4 mm	d <sub>9</sub> mm	e <sub>1</sub> ±0,1 mm	e <sub>2</sub> max mm
30	11,1	35	19,1	47,80	5,5	24	33,5	15,0	16,4	19,0	4	21	5,0
40	11,1	35	19,1	68,40	8,2	32	42,5	18,5	22,8	25,0	4	27	5,0
50	11,1	35	19,1	101,75	11,5	47	61,5	30,0	35,5	37,7	6	42	7,0
50	11,1	38	19,1	161,80	14,0	59	76,0	49,0	54,2	59,3	8	66	9,2

<p><b>11.160</b></p>  <p>B.03</p>	<p><b>11.165</b></p>  <p>B.07</p>	<p><b>11.180</b></p>  <p>B.08</p>	<p><b>11.210</b></p>  <p>B.09</p>	<p><b>11.215</b></p>  <p>B.11</p>
<p><b>11.216</b></p>  <p>B.13</p>	<p><b>11.225/6</b></p>  <p>B.14</p>	<p><b>11.290</b></p>  <p>B.15</p>	<p><b>11.295</b></p>  <p>B.16</p>	<p><b>11.296</b></p>  <p>B.17</p>
<p><b>11.300</b></p>  <p>B.20</p>	<p><b>11.302</b></p>  <p>B.22</p>	<p><b>11.305</b></p>  <p>B.24</p>	<p><b>11.353</b></p>  <p>B.29</p>	<p><b>11.400</b></p>  <p>B.30</p>
<p><b>11.453</b></p>  <p>B.32</p>	<p><b>11.455</b></p>  <p>B.35</p>	<p><b>11.457</b></p>  <p>B.36</p>	<p><b>11.470</b></p>  <p>B.38</p>	<p><b>11.512</b></p>  <p>B.39</p>
<p><b>11.610</b></p>  <p>B.40</p>	<p><b>11.620</b></p>  <p>B.42</p>	<p><b>11.630</b></p>  <p>B.43</p>	<p><b>11.999</b></p>  <p>B.44</p>	<p><b>A11.160</b> Antivibratory Schwingungsgedämpft</p>  <p>B.05</p>
<p><b>A11.160</b> Antivibratory Schwingungsgedämpft</p>  <p>B.06</p>	<p><b>A11.315</b> Antivibratory Schwingungsgedämpft</p>  <p>B.28</p>	<p><b>13.160</b> Form B Similar DIN 69871</p>  <p>B.04</p>	<p><b>13.210</b></p>  <p>B.10</p>	<p><b>13.215</b></p>  <p>B.12</p>
<p><b>13.296</b></p>  <p>B.18</p>	<p><b>13.297</b></p>  <p>B.19</p>	<p><b>13.300</b></p>  <p>B.21</p>	<p><b>13.302</b></p>  <p>B.23</p>	<p><b>13.306</b></p>  <p>B.25</p>

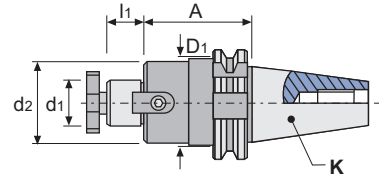





<p><b>13.307</b></p>  <p>B.26</p>	<p><b>13.315</b></p>  <p>B.27</p>	<p><b>13.453</b></p>  <p>B.34</p>	<p><b>13.457</b></p>  <p>B.37</p>	<p><b>13.610</b></p>  <p>B.41</p>
<p><b>SET-C20/32</b></p>  <p>B.31</p>	<p><b>SET</b></p>  <p>B.33</p>			

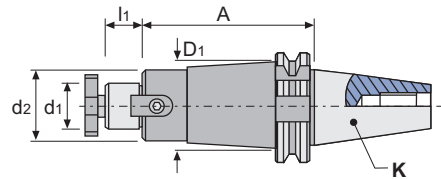





REF.	K ISO	d <sub>1</sub> h6 mm	A mm	l <sub>1</sub> mm	d <sub>2</sub> mm	D <sub>1</sub> mm				
11.160.30.16	30	16	40	17	38	-	10008	86016	11103	0,620
11.160.30.22		22	40	19	48	-	10010	86022	11004	0,800
11.160.30.27		27	40	21	58	-	10012	86027	11005	0,740
11.160.40.16	40	16	35	17	38	-	10008	86016	11103	1,080
11.160.40.16/100		16	100	17	38	38	10008	86016	11103	1,470
11.160.40.22		22	35	19	48	-	10010	86022	11004	1,160
11.160.40.22/100		22	100	19	48	48	10010	86022	11004	2,130
11.160.40.27		27	60	21	58	-	10012	86027	11005	1,360
11.160.40.27/100		27	100	21	58	58	10012	86027	11005	2,710
11.160.40.32		32	60	24	78	-	10016	86032	11105	1,820
11.160.40.32/125		32	125	24	78	63	10016	86032	11105	3,000
11.160.40.40		40	60	27	88	-	10020	86040	11006	2,200
11.160.50.16	50	16	35	17	38	-	10008	86016	11103	2,990
11.160.50.16/100		16	100	17	38	-	10008	86016	11103	-
11.160.50.16/150		16	150	17	38	-	10008	86016	11103	4,040
11.160.50.22		22	35	19	48	-	10010	86022	11004	3,130
11.160.50.22/100		22	100	19	48	-	10010	86022	11004	-
11.160.50.22/150		22	150	19	48	-	10010	86022	11004	4,660
11.160.50.27		27	40	21	58	-	10012	86027	11005	3,440
11.160.50.27/100		27	100	21	58	-	10012	86027	11005	-
11.160.50.27/150		27	150	21	58	-	10012	86027	11005	5,240
11.160.50.32		32	50	24	78	-	10016	86032	11105	4,150
11.160.50.32/100		32	100	24	78	-	10016	86032	11105	-
11.160.50.32/150		32	150	24	78	-	10016	86032	11105	7,910
11.160.50.40		40	50	27	88	80	10020	86040	11006	4,120
11.160.50.40/150		40	150	27	88	80	10020	86040	11006	7,460
11.160.50.50		50	65	30	90	-	10024	86050	11008	5,300

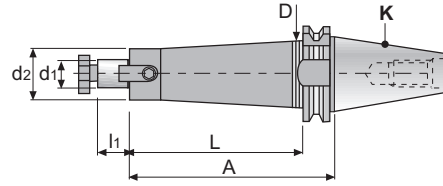

REF.	K ISO	d <sub>1</sub> h6 mm	A mm	l <sub>1</sub> mm	d <sub>2</sub> mm	D <sub>1</sub> mm				
13.160.40.16	40	16	35	17	38	-	10008	86016	11103	1,070
13.160.40.16/100		16	100	17	38	38	10008	86016	11003	1,540
13.160.40.22		22	35	19	48	-	10010	86022	11004	1,120
13.160.40.22/100		22	100	19	48	48	10010	86022	11004	2,020
13.160.40.27		27	60	21	58	-	10012	86027	11005	1,360
13.160.40.27/100		27	100	21	58	58	10012	86027	11005	2,030
13.160.40.32		32	60	24	78	-	10016	86032	11105	1,850
13.160.40.32/125		32	125	24	78	63	10016	86032	11105	2,730
13.160.40.40		40	60	27	88	-	10020	86040	11006	2,060
13.160.50.16		50	16	35	17	38	-	10008	86016	11103
13.160.50.16/100	16		100	17	38	-	10008	86016	11103	-
13.160.50.16/150	16		150	17	38	-	10008	86016	11103	3,780
13.160.50.22	22		35	19	48	-	10010	86022	11004	2,990
13.160.50.22/100	22		100	19	48	-	10010	86022	11004	-
13.160.50.22/150	22		150	19	48	-	10010	86022	11004	4,170
13.160.50.27	27		40	21	58	-	10012	86027	11005	3,250
13.160.50.27/100	27		100	21	58	-	10012	86027	11005	-
13.160.50.27/150	27		150	21	58	-	10012	86027	11005	5,290
13.160.50.32	32		50	24	78	-	10016	86032	11105	3,990
13.160.50.32/100	32		100	24	78	-	10016	86032	11105	-
13.160.50.32/150	32		150	24	78	-	10016	86032	11105	7,560
13.160.50.40	40		50	27	88	80	10020	86040	11006	3,920
13.160.50.40/150	40		150	27	88	80	10020	86040	11006	8,190
13.160.50.50	50		65	30	90	-	10024	86050	11008	4,990



REF.	K ISO	d <sub>1</sub> h6 mm	A mm	L mm	D mm	l <sub>1</sub> mm	d <sub>2</sub> mm					
A11.160.40.16/150	40	16	150	131	50	17	38	10008	86016	11103	2,200	
A11.160.40.16/200		16	200	181	50	17	38	10008	86016	11103	2,710	
A11.160.40.16/250		16	250	231	231	50	17	38	10008	86016	11103	3,250
A11.160.40.16/300		16	300	281	281	50	17	38	10008	86016	11103	3,740
A11.160.40.22/150		22	150	131	50	19	44	10010	86022	11004	2,640	
A11.160.40.22/200		22	200	181	50	19	44	10010	86022	11004	3,320	
A11.160.40.22/250		22	250	231	231	50	19	44	10010	86022	11004	4,030
A11.160.40.22/300		22	300	281	281	50	19	44	10010	86022	11004	4,750
A11.160.40.27/150		27	150	131	50	21	54	10012	86027	11005	3,100	
A11.160.40.27/200		27	200	181	50	21	54	10012	86027	11005	4,020	
A11.160.40.27/250		27	250	231	231	50	21	54	10012	86027	11005	5,000
A11.160.40.27/300		27	300	281	281	50	21	54	10012	86027	11005	5,840
A11.160.50.16/150	50	16	150	131	80	17	38	10008	86016	11103	4,610	
A11.160.50.16/200		16	200	181	80	17	38	10008	86016	11103	-	
A11.160.50.16/250		16	250	231	80	17	38	10008	86016	11103	5,940	
A11.160.50.16/300		16	300	281	80	17	38	10008	86016	11103	6,750	
A11.160.50.16/400	16	400	381	80	17	38	10008	86016	11103	10,540		
A11.160.50.22/200		22	200	181	80	19	44	10010	86022	11004	5,780	
A11.160.50.22/250		22	250	231	80	19	44	10010	86022	11004	6,550	
A11.160.50.22/300		22	300	281	80	19	44	10010	86022	11004	7,380	
A11.160.50.22/400		22	400	381	80	19	44	10010	86022	11004	-	
A11.160.50.22/500	22	500	481	80	19	44	10010	86022	11004	11,530		
A11.160.50.27/200		27	200	181	80	21	58	10012	86027	11005	6,550	
A11.160.50.27/250		27	250	231	80	21	58	10012	86027	11005	7,500	
A11.160.50.27/300		27	300	281	80	21	58	10012	86027	11005	8,600	
A11.160.50.27/400		27	400	381	80	21	58	10012	86027	11005	10,670	
A11.160.50.27/500	27	500	481	80	21	58	10012	86027	11005	13,520		
A11.160.50.32/200		32	200	181	80	24	78	10016	86032	11105	7,800	
A11.160.50.32/250		32	250	231	80	24	78	10016	86032	11105	9,170	
A11.160.50.32/300		32	300	281	80	24	78	10016	86032	11105	10,660	
A11.160.50.32/400		32	400	381	80	24	78	10016	86032	11105	13,910	
A11.160.50.32/500	32	500	481	80	24	78	10016	86032	11105	17,000		

**SPECIAL FOR MOULD AND DIE MAKERS  
BESONDERS EMPFOHLEN FÜR WERKZEUG-  
UND FORMENBAU**



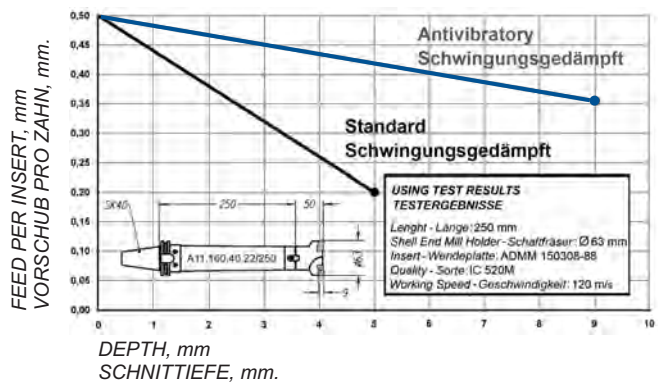

Vibration reduced up to 60% compared to any other conventional shell mill adaptor, as they are manufactured with materials and mechanisms having antivibration properties.

60% weniger Schwingungen im Vergleich mit anderen herkömmlichen Aufsteckfräsdorne, da diese mit Materialien und Mechanismen hergestellt worden sind, die schwingungsdämpfende Eigenschaften haben.

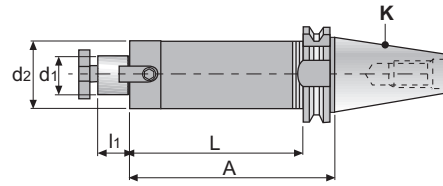
**COMPARISON WHEN USING AN ANTIVIBRATORY TOOLHOLDER  
VERGLEICH WENN MAN EINEN SCHWINGUNGSGEDÄMPFTEN  
AUFSTECKFRÄSDORN VERWENDET**





REF.	K ISO	d <sub>1</sub> h6 mm	A mm	L mm	l <sub>1</sub> mm	d <sub>2</sub> mm					
A11.160.40.16/150-39	40	16	150	131	17	39	10008	86016	11103		
A11.160.40.16/200-39		16	200	181	17	39	10008	86016	11103		
A11.160.40.16/250-39		16	250	231	17	39	10008	86016	11103		
A11.160.40.16/300-39		16	300	281	17	39	10008	86016	11103		
A11.160.40.22/150-49		22	150	131	19	49	10010	86022	11004		
A11.160.40.22/200-49		22	200	181	19	49	10010	86022	11004		
A11.160.40.22/250-49		22	250	231	19	49	10010	86022	11004		
A11.160.40.22/300-49		22	300	281	19	49	10010	86022	11004		
A11.160.40.27/150-62		27	150	131	21	62	10012	86027	11005		
A11.160.40.27/200-62		27	200	181	21	62	10012	86027	11005		
A11.160.40.27/250-62		27	250	231	21	62	10012	86027	11005		
A11.160.40.27/300-62		27	300	281	21	62	10012	86027	11005		
A11.160.50.16/150-39	50	16	150	131	17	39	10008	86016	11103		
A11.160.50.16/200-39		16	200	181	17	39	10008	86016	11103		
A11.160.50.16/250-39		16	250	231	17	39	10008	86016	11103		
A11.160.50.16/300-39		16	300	281	17	39	10008	86016	11103		
A11.160.50.16/400-39	16	400	381	17	39	39	10008	86016	11103		
A11.160.50.22/200-49		22	200	181	19	49	10010	86022	11004		
A11.160.50.22/250-49		22	250	231	19	49	49	10010	86022	11004	
A11.160.50.22/300-49		22	300	281	19	49	49	10010	86022	11004	
A11.160.50.22/400-49		22	400	381	19	49	49	10010	86022	11004	
A11.160.50.22/500-49	22	500	481	19	49	49	10010	86022	11004		
A11.160.50.27/200-62		27	200	181	21	62	10012	86027	11005		
A11.160.50.27/250-62		27	250	231	21	62	62	10012	86027	11005	
A11.160.50.27/300-62		27	300	281	21	62	62	10012	86027	11005	
A11.160.50.27/400-62		27	400	381	21	62	62	10012	86027	11005	
A11.160.50.27/500-62	27	500	481	21	62	62	10012	86027	11005		
A11.160.50.32/200-79		32	200	181	24	79	10016	86032	11105		
A11.160.50.32/250-79		32	250	231	24	79	79	10016	86032	11105	
A11.160.50.32/300-79		32	300	281	24	79	79	10016	86032	11105	
A11.160.50.32/400-79		32	400	381	24	79	79	10016	86032	11105	
A11.160.50.32/500-79	32	500	481	24	79	79	10016	86032	11105		

### SPECIAL FOR MOULD AND DIE MAKERS BESONDERS EMPFOHLEN FÜR WERKZEUG- UND FORMENBAU

Vibration reduced up to 60% compared to any other conventional shell mill adaptor, as they are manufactured with materials and mechanisms having antivibration properties.

60% weniger Schwingungen im Vergleich mit anderen herkömmlichen Aufsteckfräsdorne, da diese mit Materialien und Mechanismen hergestellt worden sind, die schwingungsdämpfende Eigenschaften haben.

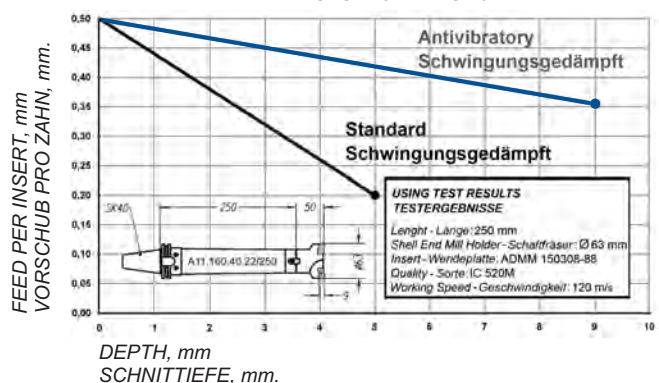

### COMPARISON WHEN USING AN ANTIVIBRATORY TOOLHOLDER VERGLEICH WENN MAN EINEN SCHWINGUNGSGEDÄMPFTEN AUFSTECKFRÄSDORN VERWENDET



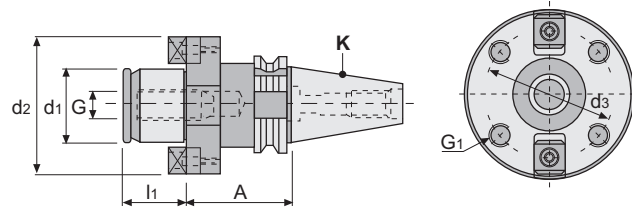



REF.	K ISO	d <sub>1</sub> g5 mm	A mm	d <sub>2</sub> mm	d <sub>3</sub> mm	G mm	G <sub>1</sub> mm	l <sub>1</sub> mm	⚖ kg
11.165.40.40	40	40	60	89	66,7	M-20	M-12	30	2,540
11.165.50.40	50	40	70	89	66,7	M-20	M-12	30	5,190
11.165.50.60		60	70	129	101,6	M-30	M-16	40	7,010

REF.		
11.165.40.40	80040	11006
11.165.50.40	80040	11006
11.165.50.60	80060	11012

**CANELA****COMBI-SHELL MILL ADAPTOR**



for cutters with keyway or driving slot DIN 138

**KOMBI-AUFSTECKFRÄSDORNE**

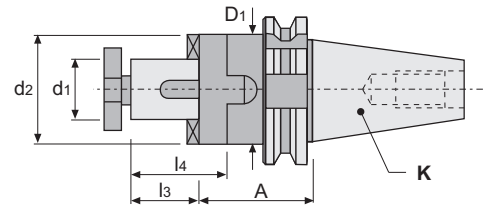
für Fräser mit Längsnut oder Stirnmitnehmer DIN 138



**DIN 69871-A****DIN 6358 - Form B****11.180**

REF.	K ISO	d <sub>1</sub> h6 mm	A mm	l <sub>3</sub> mm	l <sub>4</sub> mm	d <sub>2</sub> mm	D <sub>1</sub> mm	Ⓚ <sub>kg</sub>
11.180.30.16	30	16	50	17	27	32	-	0,660
11.180.30.22		22	50	19	31	40	-	0,680
11.180.30.27		27	55	21	33	48	-	1,000
11.180.40.16	40	16	55	17	27	32	-	1,140
11.180.40.16/100		16	100	17	27	32	35	1,490
11.180.40.22		22	55	19	31	40	-	1,300
11.180.40.22/100		22	100	19	31	40	48	1,900
11.180.40.27		27	55	21	33	48	-	1,510
11.180.40.27/100		27	100	21	33	48	48	2,040
11.180.40.32		32	60	24	38	58	-	1,820
11.180.40.32/100		32	100	24	38	58	58	2,660
11.180.40.40		40	60	27	41	70	-	2,210
11.180.50.16		50	16	55	17	27	32	-
11.180.50.16/100	16		100	17	27	32	35	3,590
11.180.50.22	22		55	19	31	40	-	3,250
11.180.50.22/100	22		100	19	31	40	48	3,820
11.180.50.27	27		55	21	33	48	-	3,400
11.180.50.27/100	27		100	21	33	48	60	4,300
11.180.50.32	32		55	24	38	58	-	3,750
11.180.50.32/100	32		100	24	38	58	78	5,260
11.180.50.40	40		55	27	41	70	-	3,750
11.180.50.40/100	40		100	27	41	70	78	5,820
11.180.50.50	50	70	30	46	90	-	5,730	

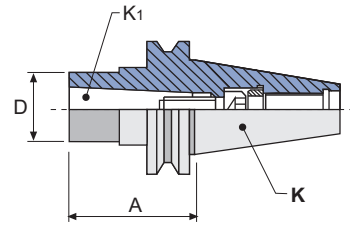
REF.			
11.180.30.16	10008	60116	88016
11.180.30.22	10010	60122	88022
11.180.30.27	10012	60127	88027
11.180.40.16	10008	60116	88016
11.180.40.16/100	10008	60116	88016
11.180.40.22	10010	60122	88022
11.180.40.22/100	10010	60122	88022
11.180.40.27	10012	60127	88027
11.180.40.27/100	10012	60127	88027
11.180.40.32	10016	60132	88032
11.180.40.32/100	10016	60132	88032
11.180.40.40	10020	60140	88040
11.180.50.16	10008	60116	88016
11.180.50.16/100	10008	60116	88016
11.180.50.22	10010	60122	88022
11.180.50.22/100	10010	60122	88022
11.180.50.27	10012	60127	88027
11.180.50.27/100	10012	60127	88027
11.180.50.32	10016	60132	88032
11.180.50.32/100	10016	60132	88032
11.180.50.40	10020	60140	88040
11.180.50.40/100	10020	60140	88040
11.180.50.50	10024	60150	88050



REF.	K ISO	K <sub>1</sub> MORSE	A mm	D mm	⚖️ kg
11.210.30.01	30	1	50	25	0,530
11.210.30.02		2	70	32	0,670
11.210.30.03		3	100	40	1,000
11.210.40.01	40	1	50	25	1,000
11.210.40.02		2	50	32	0,990
11.210.40.03		3	70	40	1,170
11.210.40.04		4	95	48	1,410
11.210.50.01	50	1	45	25	2,870
11.210.50.02		2	60	32	2,950
11.210.50.03		3	65	40	3,060
11.210.50.04		4	70	48	3,080
11.210.50.05		5	100	63	3,480

REF.			
11.210.30.01	16105	19312	11106
11.210.30.02	16105	19315	12110
11.210.30.03	16105	19318	12012
11.210.40.01	16205	19516	11206
11.210.40.02	16205	19416	18010
11.210.40.03	16205	19420	11312
11.210.40.04	16205	19322	12016
11.210.50.01	16205	19624	11206
11.210.50.02	16205	19324	11110
11.210.50.03	16205	19524	11212
11.210.50.04	16205	19424	12016
11.210.50.05	16205	19338	11020

**REDUCING ADAPTORS**



for tools with Morse taper shank and drawbar thread DIN 228-A

**REDUZIERHÜLSEN**

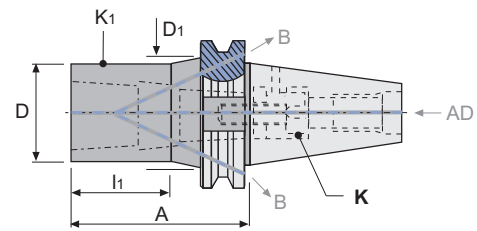
für Werkzeuge mit Morsekegel und Anzugsgewinde DIN 228-A

**DIN 69871-A****ISO 3937****13.210**

REF.	K ISO	K <sub>1</sub> MORSE	A mm	D mm	D <sub>1</sub> mm	l <sub>1</sub> mm	
13.210.40.01	40	1	50	25	45	16	1,010
13.210.40.02		2	50	32	50	19	1,020
13.210.40.03		3	70	40	50	42	1,160
13.210.40.04		4	95	48			1,420
13.210.50.01	50	1	45	25	80	16	3,060
13.210.50.02		2	60	32	80	23	3,520
13.210.50.03		3	65	40	80	28	3,530
13.210.50.04		4	70	48	80	37	3,360
13.210.50.05		5	100	63	80	66	-

REF.		REF.		
13.210.40.01	16205		19516	18006
13.210.40.02	16205		19416	18010
13.210.40.03	16205		19420	18012
13.210.40.04	16205		19322	18016
13.210.50.01	16205		19624	18006
13.210.50.02	16205		19324	18110
13.210.50.03	16205		19524	18112
13.210.50.04	16205		19424	18016
13.210.50.05	16205		19338	18020

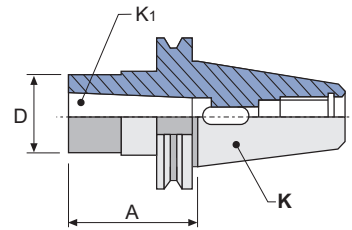

REF.	K ISO	K <sub>1</sub> MORSE	A mm	D mm	⚖️ kg
11.215.30.01	30	1	50	25	0,490
11.215.30.02		2	60	32	0,550
11.215.30.03		3	80	40	0,760
11.215.40.01	40	1	50	25	0,920
11.215.40.02		2	50	32	0,940
11.215.40.03		3	70	40	1,090
11.215.40.04		4	95	48	1,330
11.215.50.01	50	1	45	25	2,810
11.215.50.02		2	60	32	2,870
11.215.50.03		3	65	40	2,910
11.215.50.04		4	95	48	3,150
11.215.50.05		5	105	63	3,340

11 13  
DIN 69871-A

16  
HSK DIN 69833-

17  
TS ISO 26622-1

18  
PSC ISO 26623-1

20 23  
JIS B 6330-BT

25  
CHIRON

BORING HEADS  
BOHRKÖPFE

MORSE SHANKS  
MORSE SCHÄFTE

CYLINDRICAL SHANKS  
ZYLINDRISCHE SCHÄFTE

ACCESSORIES  
ZUBEHÖR





**REDUCING ADAPTORS**

for tools with Morse taper and tang DIN 228-B shank

**REDUZIERHÜLSEN**

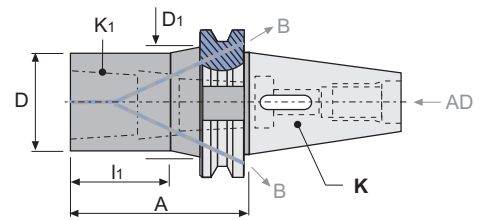
für Werkzeuge mit Morsekegel und Austreibblappen DIN 228-B



REF.	K ISO	K <sub>1</sub> MORSE	A mm	D mm	D <sub>1</sub> mm	I <sub>1</sub> mm	
13.215.40.01	40	1	50	25	45	16	0,940
13.215.40.02		2	50	32	50	18	0,970
13.215.40.03		3	70	40	50	42	1,100
13.215.40.04		4	95	48	-	-	1,310
13.215.50.01	50	1	45	25	80	16	3,080
13.215.50.02		2	60	32	80	23	3,400
13.215.50.03		3	65	40	80	28	3,380
13.215.50.04		4	95	48	80	49	3,460
13.215.50.05		5	105	63	80	71	3,410

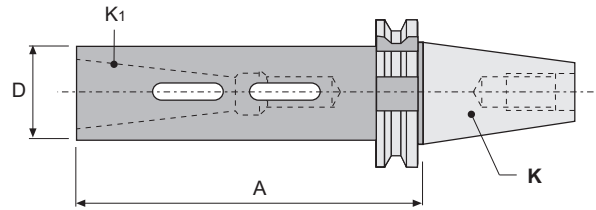

REF.	K ISO	K <sub>1</sub> MORSE	A mm	D mm	⚖️ kg
11.216.30.01	30	1	115	25	0,750
11.216.30.02		2	125	32	0,960
11.216.30.03		3	145	40	1,320
11.216.40.01	40	1	115	25	1,200
11.216.40.02		2	125	32	1,440
11.216.40.03		3	145	40	1,770
11.216.40.04		4	165	48	2,230
11.216.50.01	50	1	120	25	-
11.216.50.02		2	135	32	3,410
11.216.50.03		3	155	40	3,810
11.216.50.04		4	180	48	4,380
11.216.50.05		5	215	63	5,840

11 13  
DIN 69871-A

16  
HSK DIN 69893-

17  
TS ISO 26622-1

18  
PSC ISO 26623-1

20 23  
JIS B 6339-BT

25  
CHIRON

BORING HEADS  
BOHRKÖPFE

MORSE SHANKS  
MORSE SCHÄFTE

CYLINDRICAL SHANKS  
ZYLINDRISCHE SCHÄFTE

ACCESSORIES  
ZUBEHÖR

## REDUCING ADAPTORS

for tools with ISO DIN 2080, DIN 69871-A and BT

## REDUZIERHÜLSEN

für Werkzeuge mit DIN 2080, DIN 69871-A und BT ISO Kegel

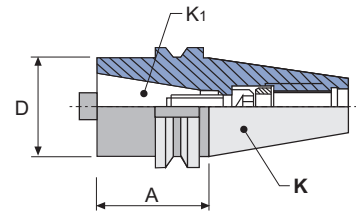

REF.	K ISO	K <sub>1</sub> DIN 2080	A mm	D mm	Kg
11.225.40.30	40	30	50	50	1,200
11.225.40.40		40	100	63	2,060
11.225.50.30		30	50	50	3,110
11.225.50.40		40	70	63	3,750
11.225.50.50	50	50	120	97	6,120

REF.	K ISO	K <sub>1</sub> DIN 69871 JIS B 6339-BT	A mm	D mm	Kg
11.226.40.30	40	30	50	50	1,170
11.226.40.40		40	100	63	2,090
11.226.50.30		30	50	50	-
11.226.50.40		40	70	63	3,550
11.226.50.50	50	50	120	97	6,240

REF.			
11.225.40.30	16205	19320	11312
11.225.40.40	16205	19322	12016
11.226.40.30	16205	19320	11412
11.226.40.40	16205	19322	12116
11.225.50.30	16205	19524	11112
11.225.50.40	16205	19424	12016
11.225.50.50	16205	19438	12024
11.226.50.30	16205	19524	11412
11.226.50.40	16205	19424	12116
11.226.50.50	16205	19438	12124

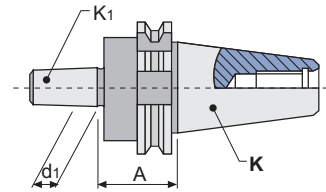

REF.	K ISO	K1 DIN	A mm	d1 mm	kg
11.290.30.12	30	B-12	25	12,065	0,450
11.290.30.16		B-16	25	15,733	0,450
11.290.40.12	40	B-12	25	12,065	0,910
11.290.40.16		B-16	25	15,733	0,930
11.290.40.18		B-18	25	17,780	0,950
11.290.50.16	50	B-16	25	15,733	2,850
11.290.50.18		B-18	25	17,780	2,850

REF.	ACCESSORIES / ZUBEHÖR
MU	Standard keyless drill chucks DIN 238 / Standard Schnellspann-Bohrfutter DIN 238
MP	Precision keyless drill chucks DIN 238 / Schnellspann-Bohrfutter DIN 238, Genauigkeitsausführung
MK	Self clamping precision keyless drill chucks DIN 238 / Selbstspann-Bohrfutter DIN 238, Genauigkeitsausführung
MH	CNC-UNIVERSAL precision drill chucks DIN 238 / CNC-Universaler Bohrfutter DIN 238, Genauigkeitsausführung



MU



MP



MK



MH

For more information see page / Für weitere Informationen siehe Seite: K.02, K.03, K.04, K.05

**CANELA****SELF CLAMPING SHORT PRECISION DRILL CHUCKS**

for right turn only

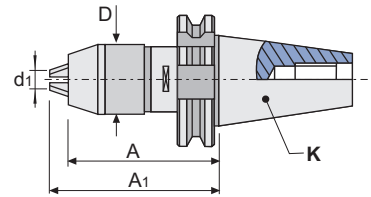

**SELBSTSPANN-KURZBOHRFUTTER, GENAUIGKEITSAUSFÜHRUNG**

nur für rechtslaufende Bearbeitungen

**DIN 69871-A****11.295**

REF.	K ISO	d <sub>1</sub> mm	D mm	A mm	A <sub>1</sub> max mm	kg
11.295.30.08	30	0- 8	36,0	76,5	84,5	0,980
11.295.40.08	40	0- 8	36,0	67,5	75,0	1,180
11.295.40.13		0-13	50,5	89,0	100,0	1,620
11.295.40.16		3-16	56,0	105,0	118,0	2,040
11.295.50.13	50	0-13	50,5	85,0	96,0	3,470
11.295.50.16		3-16	56,0	90,0	103,0	3,700

\* SUPPLIED WITH WRENCH / \* GELIEFERT MIT SCHLÜSSEL



REF.			3 x 
11.295.30.08	50008	11206	60308
11.295.40.08	50008	11206	60308
11.295.40.13	50013	11108	60313
11.295.40.16	50016	11108	60313
11.295.50.13	50013	11108	60313
11.295.50.16	50016	11108	60313

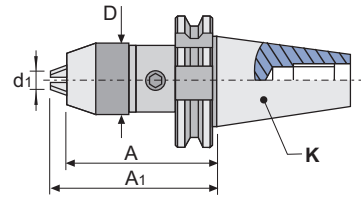



REF.	K ISO	d <sub>1</sub> mm	D mm	A mm	A <sub>1</sub> max mm	kg
11.296.30.13	30	1-13	50	103,0	110,0	1,350
11.296.40.13	40	1-13	50	81,5	88,5	1,550
11.296.40.16		3-16	56	88,5	95,5	1,830
11.296.50.13	50	1-13	50	81,5	88,5	3,500
11.296.50.16		3-16	56	88,5	95,5	3,760

\* SUPPLIED WITH WRENCH / \* GELIEFERT MIT SCHLÜSSEL

REF.		3 x 
11.296.30.13	50706	60313
11.296.40.13	50706	60313
11.296.40.16	50706	60313
11.296.50.13	50706	60313
11.296.50.16	50706	60313

**CANELA****CNC-UNIVERSAL PRECISION DRILL CHUCKS**

for left and right hand turn

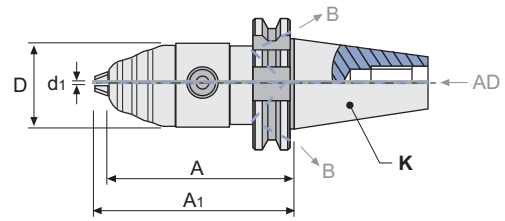

**UNIVERSALER CNC-BOHRFUTTER, GENAUIGKEITSAUSFÜHRUNG**

für links- und rechtslaufende Bearbeitungen

**DIN 69871-A****13.296**

REF.	K ISO	d <sub>1</sub> mm	D mm	A mm	A <sub>1</sub> max mm	
13.296.30.13	30	1-13	50	103,0	110,0	1,360
13.296.40.13	40	1-13	50	81,5	88,5	1,540
13.296.40.16		3-16	56	88,5	95,5	1,880
13.296.50.13	50	1-13	50	81,5	88,5	3,420
13.296.50.16		3-16	56	88,5	95,5	3,690

\* SUPPLIED WITH WRENCH / \* GELIEFERT MIT SCHLÜSSEL

REF.		3 x 
13.296.30.13	50706	60313
13.296.40.13	50706	60313
13.296.40.16	50706	60313
13.296.50.13	50706	60313
13.296.50.16	50706	60313

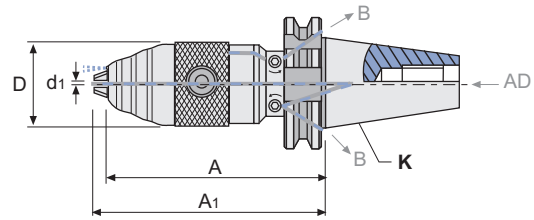



REF.	K ISO	d <sub>1</sub> mm	D mm	A mm	A <sub>1</sub> max mm	⚖️ Kg
13.297.40.13	40	1-13	56	105	112	2,080
13.297.40.16		3-16	56	112	119	-
13.297.50.13	50	1-13	56	105	112	4,320
13.297.50.16		3-16	56	112	119	-



The coolant can be supplied in different ways: through the coolant holes of the tool, through the front part of the drill chuck or through both parts simultaneously.

Das Kühlmittel kann auf verschiedenen Weisen verteilt werden: durch die Kühlmittel-Löcher des Werkzeugs, durch den Vorderteil des Bohrfutters oder durch beide Teile gleichzeitig.

**\* SUPPLIED WITH WRENCH / \* GELIEFERT MIT SCHLÜSSEL**

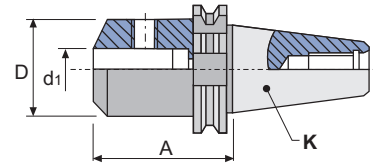
REF.		
13.297.40.13	50706	60313
13.297.40.16	50706	60313
13.297.50.13	50706	60313
13.297.50.16	50706	60313



REF.	K ISO	d <sub>1</sub> H4 mm	A mm	D mm		
11.300.30.06	30	6	50	25	15106	0,500
11.300.30.08		8	50	28	15108	0,520
11.300.30.10		10	50	35	15110	0,610
11.300.30.12		12	50	42	15212	-
11.300.30.14		14	50	44	15212	-
11.300.30.16		16	63	48	15314	0,850
11.300.30.18		18	63	50	15314	0,880
11.300.40.06	40	6	50	25	15106	0,940
11.300.40.08		8	50	28	15108	0,970
11.300.40.10		10	50	35	15110	1,030
11.300.40.12		12	50	42	15212	1,120
11.300.40.14		14	50	44	15212	1,130
11.300.40.16		16	63	48	15314	1,340
11.300.40.18		18	63	50	15314	1,370
11.300.40.20		20	63	52	15216	1,380
11.300.40.25		25	100	65	2 x 15218	2,370
11.300.40.32		32	100	72	2 x 15220	2,710
11.300.40.40		40	120	90	2 x 15220	4,280
11.300.50.06	50	6	63	25	15106	2,860
11.300.50.08		8	63	28	15108	2,890
11.300.50.10		10	63	35	15110	2,920
11.300.50.12		12	63	42	15212	3,070
11.300.50.14		14	63	44	15212	3,110
11.300.50.16		16	63	48	15314	3,170
11.300.50.18		18	63	50	15314	3,190
11.300.50.20		20	63	52	15216	3,260
11.300.50.25		25	80	65	2 x 15218	3,910
11.300.50.32		32	100	72	2 x 15220	4,670
11.300.50.40		40	120	90	2 x 15220	6,310
11.300.50.50		50	120	98	2 x 15024	6,700

REF.	ACCESSORIES / ZUBEHÖR
42.300	Short and long reducing bushings DIN 1835-B Form A and B / Kurze und lange Reduzierhülsen DIN 1835-B Form A und B
42.311	Short and long reducing bushings DIN 1835-B Form C / Kurze und lange Reduzierhülsen DIN 1835-B Form C





42.300

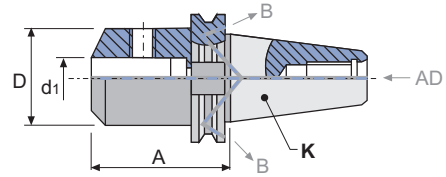

42.311

For more information see page / Für weitere Informationen siehe Seite: J.11, J.12



REF.	K ISO	d <sub>1</sub> H4 mm	A mm	D mm		
13.300.40.06	40	6	50	25	15106	0,930
13.300.40.08		8	50	28	15108	0,980
13.300.40.10		10	50	35	15110	1,050
13.300.40.12		12	50	42	15212	1,090
13.300.40.14		14	50	44	15212	1,120
13.300.40.16		16	63	48	15314	1,350
13.300.40.18		18	63	50	15314	1,370
13.300.40.20		20	63	52	15216	1,350
13.300.40.25		25	100	65	2 x 15218	2,360
13.300.40.32		32	100	72	2 x 15220	2,580
13.300.40.40		40	120	90	2 x 15220	4,260
13.300.50.06		50	6	63	25	15106
13.300.50.08	8		63	28	15108	2,780
13.300.50.10	10		63	35	15110	2,960
13.300.50.12	12		63	42	15212	3,070
13.300.50.14	14		63	44	15212	3,060
13.300.50.16	16		63	48	15314	3,110
13.300.50.18	18		63	50	15314	3,200
13.300.50.20	20		63	52	15216	3,220
13.300.50.25	25		80	65	2 x 15218	3,880
13.300.50.32	32		100	72	2 x 15220	4,690
13.300.50.40	40		120	90	2 x 15220	6,290
13.300.50.50	50		120	98	2 x 15024	6,740

REF.	ACCESSORIES / ZUBEHÖR
42.300	Short and long reducing bushings DIN 1835-B Form A and B / Kurze und lange Reduzierhülsen DIN 1835-B Form A und B
42.311	Short and long reducing bushings DIN 1835-B Form C / Kurze und lange Reduzierhülsen DIN 1835-B Form C



42.300



42.311

For more information see page / Für weitere Informationen siehe Seite: J.11, J.12

**SHORT END MILL ADAPTORS**

for cutters and tooling with cylindrical shank and weldon flat DIN 1835-B

**KURZE AUFSTECKFRÄSDORNE**

für Fräser und Werkzeuge mit zylindrischem Schaft und Weldon-Fläche DIN 1835-B

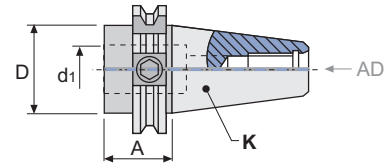



REF.	K ISO	d <sub>1</sub> H4 mm	A mm	D mm	kg
11.302.30.16	30	16	32	32	0,440
11.302.30.20		20	34	36	0,500
11.302.40.16	40	16	35	44	0,980
11.302.40.20		20	35	44	1,000
11.302.40.25		25	35	44	0,850
11.302.40.32		32	35	44	-
11.302.50.16	50	16	35	70	3,140
11.302.50.20		20	35	70	3,100
11.302.50.25		25	35	70	2,980
11.302.50.32		32	35	70	2,830

REF.	
11.302.30.16	15114
11.302.30.20	15014
11.302.40.16	15214
11.302.40.20	15116
11.302.40.25	15016
11.302.40.32	15020
11.302.50.16	15314
11.302.50.20	15216
11.302.50.25	15118 + 15218
11.302.50.32	15020 + 15120

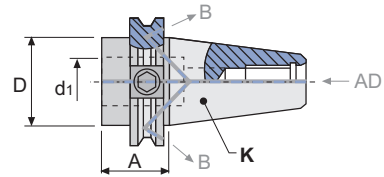



REF.	K ISO	d <sub>1</sub> H4 mm	A mm	D mm		 kg
13.302.40.16	40	16	35	44	15214	0,950
13.302.40.20		20	35	44	15116	0,890
13.302.40.25		25	35	44	15016	0,840
13.302.40.32		32	35	44	15020	-
13.302.50.16	50	16	35	70	15314	3,030
13.302.50.20		20	35	70	15216	3,070
13.302.50.25		25	35	70	15118 + 15218	2,910
13.302.50.32		32	35	70	15020 + 15120	2,790

REF.	ACCESSORIES / ZUBEHÖR
42.610	Tapping head with axial compensation DIN 1835-B / Gewindefutter, mit Längenausgleich DIN 1835-B
42.620	Quick change tapping head with axial compensation DIN 1835-B+E / Gewindefutter-Schnellwechselfutter mit Längenausgleich DIN 1835-B + E







42.610



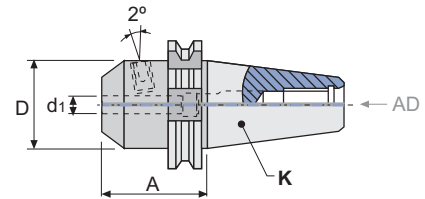

42.620

For more information see page / Für weitere Informationen siehe Seite: J.14, J.15

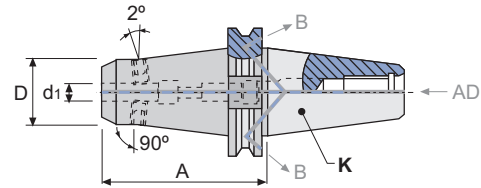

REF.	K ISO	d <sub>1</sub> H4 mm	A mm	D mm			
11.305.30.06	30	6	50	25	19005	15106	0,560
11.305.30.08		8	50	28	19106	15108	0,560
11.305.30.10		10	50	35	19008	15110	0,640
11.305.30.12		12	50	42	19110	15212	0,700
11.305.30.14		14	50	44	19110	15212	0,660
11.305.30.16		16	63	48	19012	15314	0,880
11.305.30.18		18	63	50	19012	15314	0,850
11.305.40.06	40	6	50	25	19005	15106	0,960
11.305.40.08		8	50	28	19106	15108	0,980
11.305.40.10		10	50	35	19008	15110	1,050
11.305.40.12		12	50	42	19110	15212	1,140
11.305.40.14		14	50	44	19110	15212	1,150
11.305.40.16		16	63	48	19012	15314	1,360
11.305.40.18		18	63	50	19012	15314	1,370
11.305.40.20		20	63	52	19016	15216	1,380
11.305.40.25		25	100	65	19020	2 x 15218	2,370
11.305.40.32		32	100	72	19020	2 x 15220	2,700
11.305.50.06	50	6	63	25	19005	15106	2,900
11.305.50.08		8	63	28	19106	15108	2,920
11.305.50.10		10	63	35	19008	15110	3,060
11.305.50.12		12	63	42	19110	15212	3,100
11.305.50.14		14	63	44	19110	15212	3,160
11.305.50.16		16	63	48	19012	15314	3,250
11.305.50.18		18	63	50	19012	15314	3,380
11.305.50.20		20	63	52	19016	15216	3,280
11.305.50.25		25	80	65	19020	2 x 15218	3,990
11.305.50.32		32	100	72	19020	2 x 15220	4,700
11.305.50.40		40	120	90	19020	2 x 15220	6,400



REF.	K ISO	d <sub>1</sub> H4 mm	A mm	D mm	D <sub>1</sub> mm	2 x 	 Kg
13.306.40.06/100	40	6	100	22	28	15006	1,170
13.306.40.06/130		6	130	22	28	15006	1,220
13.306.40.06/160		6	160	22	33	15006	1,410
13.306.40.08/100		8	100	24	30	15008	1,130
13.306.40.08/130		8	130	24	30	15008	1,260
13.306.40.08/160		8	160	24	35	15008	1,480
13.306.40.10/100		10	100	30	38	15010	1,410
13.306.40.10/130		10	130	30	38	15010	1,480
13.306.40.10/160		10	160	30	39	15010	1,690
13.306.40.12/100		12	100	32	40	15012	1,340
13.306.40.12/130		12	130	32	40	15012	1,610
13.306.40.12/160		12	160	32	43	15012	1,870
13.306.40.14/100		14	100	32	40	15012	1,360
13.306.40.14/130		14	130	32	40	15012	1,540
13.306.40.14/160		14	160	32	44	15012	1,840
13.306.40.16/100		16	100	36	44	15114	1,450
13.306.40.16/130		16	130	36	44	15114	1,740
13.306.40.16/160		16	160	36	44	15114	1,960
13.306.40.18/100		18	100	38	46	15114	1,490
13.306.40.18/130		18	130	38	46	15114	1,800
13.306.40.18/160		18	160	38	46	15114	2,110
13.306.40.20/100		20	100	44	50	15116	1,650
13.306.40.20/130		20	130	44	50	15116	2,060
13.306.40.20/160		20	160	44	50	15116	2,420
13.306.40.25/100		25	100	50	50	15018	1,760
13.306.40.25/130		25	130	50	50	4 x 15018	2,220
13.306.40.25/160		25	160	50	50	4 x 15018	2,620
13.306.50.06/130	50	6	130	22	28	15006	3,050
13.306.50.06/160		6	160	22	33	15006	3,250
13.306.50.06/200		6	200	22	36	15006	3,500
13.306.50.08/130		8	130	24	30	15008	3,100
13.306.50.08/160		8	160	24	35	15008	3,350
13.306.50.08/200		8	200	24	38	15008	3,600
13.306.50.10/130		10	130	30	38	15010	3,330
13.306.50.10/160		10	160	30	39	15010	3,600
13.306.50.10/200		10	200	30	43	15010	4,000
13.306.50.12/130		12	130	32	40	15012	3,360
13.306.50.12/160		12	160	32	43	15012	3,660
13.306.50.12/200		12	200	32	46	15012	4,100
13.306.50.14/130		14	130	32	40	15012	3,370
13.306.50.14/160		14	160	32	44	15012	3,670
13.306.50.14/200		14	200	32	48	15012	4,200
13.306.50.16/130		16	130	36	44	15114	3,600
13.306.50.16/160		16	160	36	44	15114	3,800
13.306.50.16/200		16	200	36	50	15114	4,400
13.306.50.18/130		18	130	38	46	15114	3,600
13.306.50.18/160		18	160	38	46	15114	3,920
13.306.50.18/200		18	200	38	52	15114	4,610
13.306.50.20/100		20	100	44	50	15116	-
13.306.50.20/130		20	130	44	50	15116	3,840
13.306.50.20/160		20	160	44	50	15116	4,300
13.306.50.20/200		20	200	44	55	15116	4,900
13.306.50.25/130		25	130	50	56	4 x 15018	4,200
13.306.50.25/160		25	160	50	60	4 x 15018	4,800
13.306.50.25/200		25	200	50	64	4 x 15018	5,600
13.306.50.32/200		32	200	58	72	4 x 15120	6,500
13.306.50.40/200		40	200	66	80	4 x 15120	6,670

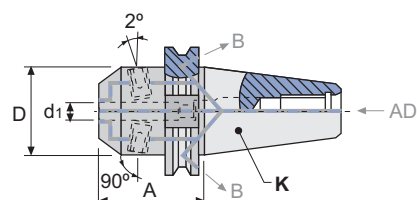

REF.	K ISO	d <sub>1</sub> H4 mm	A mm	D mm	kg
13.307.40.06	40	6	50	25	0,970
13.307.40.08		8	50	28	0,990
13.307.40.10		10	50	35	1,060
13.307.40.12		12	50	42	1,140
13.307.40.14		14	50	44	1,160
13.307.40.16		16	63	48	1,350
13.307.40.18		18	63	50	1,380
13.307.40.20		20	63	52	1,380
13.307.40.25		25	100	65	2,360
13.307.40.32		32	100	72	2,560
13.307.50.06	50	6	63	25	2,910
13.307.50.08		8	63	28	2,840
13.307.50.10		10	63	35	2,920
13.307.50.12		12	63	42	3,210
13.307.50.14		14	63	44	3,080
13.307.50.16		16	63	48	3,210
13.307.50.18		18	63	50	3,350
13.307.50.20		20	63	52	3,300
13.307.50.25		25	80	65	3,970
13.307.50.32		32	100	72	4,740
13.307.50.40		40	120	90	-

Coolant distribution trough the central or trough lateral part of the tool. / Kühlmittel-Verteilung durch die Mitte oder durch den seitlichen Teil des Werkzeugs.

REF.		2 x
13.307.40.06	19005	15106
13.307.40.08	19106	15108
13.307.40.10	19008	15110
13.307.40.12	19110	15212
13.307.40.14	19110	15212
13.307.40.16	19012	15314
13.307.40.18	19012	15314
13.307.40.20	19016	15216
13.307.40.25	19020	4 x 15218
13.307.40.32	19020	4 x 15220
13.307.50.06	19005	15106
13.307.50.08	19106	15108
13.307.50.10	19008	15110
13.307.50.12	19110	15212
13.307.50.14	19110	15212
13.307.50.16	19012	15314
13.307.50.18	19012	15314
13.307.50.20	19016	15216
13.307.50.25	19020	4 x 15218
13.307.50.32	19020	4 x 15220
13.307.50.40	19020	4 x 15220

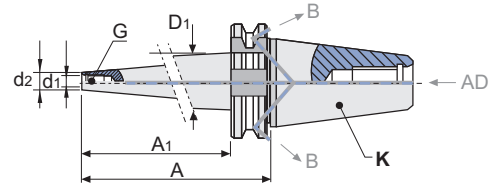

REF.	K ISO	A mm	d1 mm	G mm	d2 mm	A1 mm	D1 mm	kg
13.315.40.10/045	40	45	10,5	M10	18	25	20	0,910
13.315.40.10/070		70	10,5	M10	18	50	23	0,960
13.315.40.10/120		120	10,5	M10	18	100	29	1,150
13.315.40.12/045		45	12,5	M12	21	25	24	0,920
13.315.40.12/070		70	12,5	M12	21	50	26	0,980
13.315.40.12/120		120	12,5	M12	21	100	32	1,260
13.315.40.16/045		45	17,0	M16	29	25	32	0,930
13.315.40.16/070		70	17,0	M16	29	50	35	-
13.315.40.16/120		120	17,0	M16	29	100	40	1,530
13.315.50.12/070	50	70	12,5	M12	21	50	26	2,810
13.315.50.12/120		120	12,5	M12	21	100	32	3,110
13.315.50.12/170		170	12,5	M12	21	150	37	3,450
13.315.50.16/070		70	17,0	M16	29	50	35	2,910
13.315.50.16/120		120	17,0	M16	29	100	40	3,370
13.315.50.16/170		170	17,0	M16	29	150	45	3,910

REF.	ACCESSORIES / ZUBEHÖR
06.315	Front contact extensions for modular tools. / Stirnverlängerung für Einschraubfräser.
06.315	Front contact reducers for modular tools. / Stirnreduzierhülsen für Einschraubfräser.



06.315



06.315

For more information see page / Für weitere Informationen siehe Seite: J.02, J.03

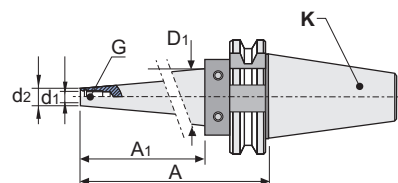

REF.	K ISO	A <sub>1</sub> mm	D <sub>1</sub> mm	A mm	D mm	d <sub>1</sub> mm	G mm	d <sub>2</sub> mm	Ⓚ kg
A11.315.40.10/200	40	165	35	200	50	10,5	M10	18	1,740
A11.315.40.10/250		215	41	250	50	10,5	M10	18	2,160
A11.315.40.10/300		265	46	300	50	10,5	M10	18	2,750
A11.315.40.12/200		165	38	200	50	12,5	M12	21	2,110
A11.315.40.12/250		215	44	250	50	12,5	M12	21	2,410
A11.315.40.12/300		265	49	300	50	12,5	M12	21	3,080
A11.315.40.16/200		165	46	200	50	17,0	M16	29	2,310
A11.315.40.16/250		215	48	250	50	17,0	M16	29	2,740
A11.315.40.16/300		265	50	300	50	17,0	M16	29	3,400
A11.315.50.12/250	50	215	44	250	80	12,5	M12	21	4,790
A11.315.50.12/300		265	49	300	80	12,5	M12	21	5,120
A11.315.50.12/400		365	60	400	80	12,5	M12	21	6,950
A11.315.50.16/250		215	52	250	80	17,0	M16	29	5,510
A11.315.50.16/300		265	57	300	80	17,0	M16	29	6,140
A11.315.50.16/400		365	68	400	80	17,0	M16	29	-
A11.315.50.16/500		465	78	500	80	17,0	M16	29	11,680

Antivibratory Shell Mill Adaptors manufactured with materials and mechanisms having antivibration properties. Standard and extra long lengths, suitable for moulding and special manufactures.

Schwingungsgedämpfte Aufsteckfräsdorne werden mit Materialien und Mechanismen hergestellt, die schwingungsdämpfende Eigenschaften haben. Sie sind für Werkzeugbau und Sonderherstellungen geeignet.

**PRE-BALANCED / VORGEWUCHTET**

ISO-40: 15.000 r.p.m. G-6,3

ISO-50: 10.000 r.p.m. G-6,3

REF.	ACCESSORIES / ZUBEHÖR
06.315	Front contact extensions for modular tools. / Stirnverlängerung für Einschraubfräser.
06.315	Front contact reducers for modular tools. / Stirnreduzierhülsen für Einschraubfräser.



06.315





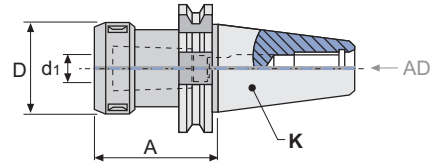

06.315

For more information see page / Für weitere Informationen siehe Seite: J.02, J.03





REF.	K ISO	A mm	d1 mm	D mm				 Kg
11.353.30.16	30	65	2-16	43	35316	50116	19216	0,900
11.353.30.25		70	3-25	60	35325	50125	19216	0,960
11.353.40.16	40	70	2-16	43	35316	50116	19216	1,120
11.353.40.16/120		120	2-16	43	35316	50116	19216	1,300
11.353.40.25		70	3-25	60	35325	50125	19224	1,270
11.353.40.25/120		120	3-25	60	35325	50125	19224	1,910
11.353.40.32		90	4-32	72	35332	50132	19224	1,780
11.353.50.16		50	70	2-16	43	35316	50116	19216
11.353.50.16/120	120		2-16	43	35316	50116	19216	3,360
11.353.50.25	85		3-25	60	35325	50125	19224	2,690
11.353.50.25/120	140		3-25	60	35325	50125	19224	3,440
11.353.50.32	90		4-32	72	35332	50132	19230	3,560
11.353.50.32/120	120		4-32	72	35332	50132	19230	3,903

\* If you want with ball bearing nut, see page: K.22  
 \* Wenn Sie diese mit Kugellager-Nute möchten, siehe Seite: K.22

\* SUPPLIED WITHOUT WRENCH / \* GELIEFERT OHNE SCHLÜSSEL

REF.	ACCESSORIES / ZUBEHÖR
BXX	Collets double slot DIN 6388 - Form B / Spannzangen mit Doppelnut DIN 6388 - Form B



BXX

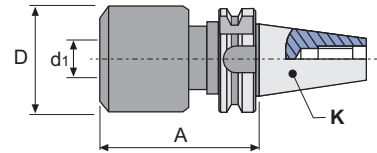

For more information see page / Für weitere Informationen siehe Seite: K.10



REF.	K ISO	A mm	d <sub>1</sub> mm	D mm	kg
11.400.40.20	40	105	20	54	1,950
11.400.40.32		105	32	72	2,550
11.400.50.20	50	105	20	54	-
11.400.50.32		105	32	72	4,450

**COMPLEMENTS (Collets type C) / ZUBEHÖR (Spannzangen typ C)**

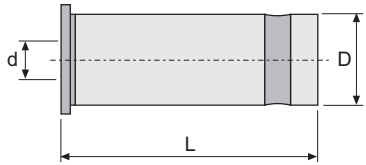
REF.	d mm	D mm	L mm
C2006	6	20	55
C2008	8	20	55
C2010	10	20	55
C2012	12	20	55
C2016	16	20	55
C3206	6	32	65
C3208	8	32	65
C3210	10	32	65
C3212	12	32	65
C3216	16	32	65
C3220	20	32	65
C3225	25	32	65



SET-C20  
SET-C32

REF.	DIN	Composition / Zusammenstellung	
SET-11.40.C20	DIN 69871-A	1 11.400.40.20 + 5 collets / spannzangen C20: Ø6, 8, 10, 12, 16	4,500
SET-11.40.C32		1 11.400.40.32 + 7 collets / spannzangen C32: Ø6, 8, 10, 12, 16, 20, 25	6,700
SET-11.50.C32		1 11.400.50.32 + 7 collets / spannzangen C32: Ø6, 8, 10, 12, 16, 20, 25	9,150

11 13  
DIN 69871-A

16  
HSK DIN 69893-

17  
TS ISO 26622-1

18  
PSC ISO 26623-1

20 23  
JIS B 6339-BT

25  
CHIRON





BORING HEADS  
BOHRKÖPFE

MORSE SHANKS  
MORSE SCHÄFTE

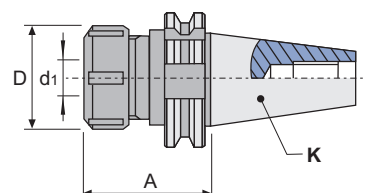
CYLINDRICAL SHANKS  
ZYLINDRISCHE SCHÄFTE

ACCESSORIES  
ZUBEHÖR



REF.	K ISO		A mm	d1 mm	D mm				
11.453.30.16	30	ER16	55	0,5-10	32	45316	50216	19210	0,490
11.453.30.20		ER20	55	1-13	35	45320	50220	19212	0,500
11.453.30.25		ER25	55	1-16	42	45325	50225	19216	0,530
11.453.30.32		ER32	60	2-20	50	45332	50232	19218	0,600
11.453.40.16	40	ER16	70	0,5-10	32	45316	50216	19210	0,990
11.453.40.16/100		ER16	100	0,5-10	32	45316	50216	19210	1,100
11.453.40.16/150		ER16	150	0,5-10	32	45316	50216	19210	1,280
11.453.40.20		ER20	70	1-13	35	45320	50220	19212	1,020
11.453.40.20/100		ER20	100	1-13	35	45320	50220	19212	1,170
11.453.40.20/150		ER20	150	1-13	35	45320	50220	19212	1,400
11.453.40.25		ER25	70	1-16	42	45325	50225	19216	1,090
11.453.40.25/100		ER25	100	1-16	42	45325	50225	19216	-
11.453.40.25/150		ER25	150	1-16	42	45325	50225	19216	1,780
11.453.40.32		ER32	70	2-20	50	45332	50232	19222	1,150
11.453.40.32/100		ER32	100	2-20	50	45332	50232	19222	-
11.453.40.32/150		ER32	150	2-20	50	45332	50232	19222	1,650
11.453.40.40		ER40	70	3-30	63	45340	50240	19224	1,280
11.453.40.40/100		ER40	100	3-30	63	45340	50240	19224	-
11.453.40.40/150		ER40	150	3-30	63	45340	50240	19224	2,430
11.453.50.16/100	50	ER16	100	0,5-10	32	45316	50216	19210	3,010
11.453.50.16/150		ER16	150	0,5-10	32	45316	50216	19210	3,100
11.453.50.20/100		ER20	100	1-13	35	45320	50220	19212	3,100
11.453.50.20/150		ER20	150	1-13	35	45320	50220	19212	3,300
11.453.50.25		ER25	70	1-16	42	45325	50225	19216	2,980
11.453.50.25/150		ER25	150	1-16	42	45325	50225	19216	3,540
11.453.50.32		ER32	70	2-20	50	45332	50232	19222	3,030
11.453.50.32/100		ER32	100	2-20	50	45332	50232	19222	-
11.453.50.32/150		ER32	150	2-20	50	45332	50232	19222	3,890
11.453.50.40		ER40	80	3-30	63	45340	50240	19224	3,310
11.453.50.40/150		ER40	150	3-30	63	45340	50240	19224	4,690
11.453.50.50		ER50	90	10-34	78	45350	50250	19230	3,700

\* SUPPLIED WITHOUT WRENCH / \* GELIEFERT OHNE SCHLÜSSEL

\* If you want with ball bearing nut, see page: K.22  
\* Wenn Sie diese mit Kugellager-Nute möchten, siehe Seite: K.22

REF.	ACCESSORIES / ZUBEHÖR
ERXX	Collets double slot DIN 6499 - Form B (ER) / Spannzangen mit Doppelnut DIN 6499 - Form B (ER)
ERCXX	Sealed collets DIN 6499 (ER) / Abgedichtete Spannzangen DIN 6499 (ER)
ERTXX	Collets DIN 6499 - Form Canela (ER) / Spannzangen DIN 6499 - Form Canela (ER)
40.453..	Collet chucks for DIN 6499 (ER) collets / Spannzangenfutter für DIN 6499 (ER) Spannzangen
40.455..	Long collet chucks for DIN 6499 (ER) collets / Lange Spannzangenfutter für DIN 6499 (ER) Spannzangen



ERXX



ERCXX



ERTXX





40.453..



40.455..

For more information see page / Für weitere Informationen siehe Seite: K.13, K.17, K.19, J.08, J.09



REF.		K ISO		n° 	 kg
SET-11.40.32	DIN 69871-A	40	ER32	18 (3-20)	-
SET-11.40.40	DIN 69871-A	40	ER40	23 (4-26)	-
SET-11.50.32	DIN 69871-A	50	ER32	18 (3-20)	-
SET-11.50.40	DIN 69871-A	50	ER40	23 (4-26)	-

11 13  
DIN 69871-A

16  
HSK DIN 69893-

17  
TS ISO 26622-1

18  
PSC ISO 26623-1

20 23  
JIS B 6339-BT

25  
CHIRON





BORING HEADS  
BOHRKÖPFE

MORSE SHANKS  
MORSE SCHÄFTE

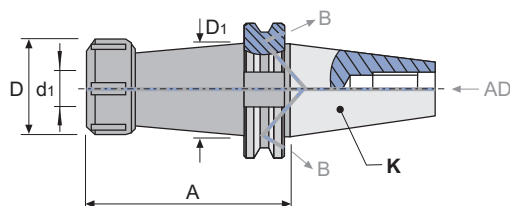
CYLINDRICAL SHANKS  
ZYLINDRISCHE SCHÄFTE

ACCESSORIES  
ZUBEHÖR



REF.	K ISO		A mm	d <sub>1</sub> mm	D mm	D <sub>1</sub> mm				
13.453.40.16	40	ER16	70	0,5-10	32	-	45316	50216	19210	0,980
13.453.40.16/100		ER16	100	0,5-10	32	28	45316	50216	19210	1,090
13.453.40.16/150		ER16	150	0,5-10	32	28	45316	50216	19210	1,260
13.453.40.20		ER20	70	1-13	35	-	45320	50220	19212	1,020
13.453.40.20/100		ER20	100	1-13	35	34	45320	50220	19212	1,160
13.453.40.20/150		ER20	150	1-13	35	34	45320	50220	19212	1,400
13.453.40.25		ER25	70	1-16	42	-	45325	50225	19216	1,080
13.453.40.25/150		ER25	150	1-16	42	42	45325	50225	19216	1,690
13.453.40.32		ER32	70	2-20	50	-	45332	50232	19222	1,140
13.453.40.32/100		ER32	100	2-20	50	50	45332	50232	19222	-
13.453.40.32/150		ER32	150	2-20	50	50	45332	50232	19222	2,010
13.453.40.40		ER40	70	3-30	63	-	45340	50240	19224	1,270
13.453.40.40/150		ER40	150	3-30	63	63	45340	50240	19224	-
13.453.50.16/100	50	ER16	100	0,5-10	32	28	45316	50216	19210	2,910
13.453.50.16/150		ER16	150	0,5-10	32	28	45316	50216	19210	3,070
13.453.50.20/100		ER20	100	1-13	35	34	45320	50220	19212	3,030
13.453.50.20/150		ER20	150	1-13	35	34	45320	50220	19212	3,260
13.453.50.25		ER25	70	1-16	42	-	45325	50225	19216	2,960
13.453.50.25/150		ER25	150	1-16	42	42	45325	50225	19216	3,530
13.453.50.32		ER32	70	2-20	50	-	45332	50232	19222	2,980
13.453.50.32/100		ER32	100	2-20	50	50	45332	50232	19222	-
13.453.50.32/150		ER32	150	2-20	50	50	45332	50232	19222	3,820
13.453.50.32/200		ER32	200	2-20	50	50	45332	50232	19222	-
13.453.50.40		ER40	80	3-30	63	-	45340	50240	19224	3,320
13.453.50.40/150		ER40	150	3-30	63	63	45340	50240	19224	4,670
13.453.50.40/200		ER40	200	3-30	63	63	45340	50240	19224	-
13.453.50.50		ER50	90	10-34	78	-	45350	50250	19230	-

\* If you want with ball bearing nut, see page: K.22

\* Wenn Sie diese mit Kugellager-Nute möchten, siehe Seite: K.22

\* SUPPLIED WITHOUT WRENCH / \* GELIEFERT OHNE SCHLÜSSEL

REF.	ACCESSORIES / ZUBEHÖR
ERXX	Collets double slot DIN 6499 - Form B (ER) / Spannanzgen mit Doppelnut DIN 6499 - Form B (ER)
ERCXX	Sealed collets DIN 6499 (ER) / Abgedichtete Spannanzgen DIN 6499 (ER)
ERTXX	Collets DIN 6499 - Form Canela (ER) / Spannanzgen DIN 6499 - Form Canela (ER)
40.453..	Collet chucks for DIN 6499 (ER) collets / Spannanzgenfutter für DIN 6499 (ER) Spannanzgen
40.455..	Long collet chucks for DIN 6499 (ER) collets / Lange Spannanzgenfutter für DIN 6499 (ER) Spannanzgen



ERXX



ERCXX



ERTXX



40.453..





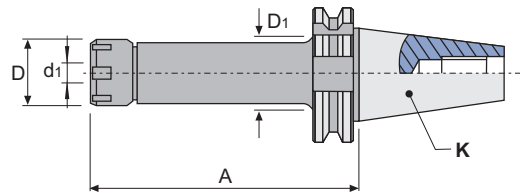

40.455..

For more information see page / Für weitere Informationen siehe Seite: K.13, K.17, K.19, J.08, J.09





REF.	K ISO		A mm	d <sub>1</sub> mm	D mm	D <sub>1</sub> mm				
11.455.40.16/100	40	ER16	100	0,5-10	22	22	45516	50916	19210	-
11.455.40.16/130		ER16	130	0,5-10	22	22	45516	50916	19210	-
11.455.40.16/160		ER16	160	0,5-10	22	22	45516	50916	19210	-
11.455.40.16/200		ER16	200	0,5-10	22	22	45516	50916	19210	-
11.455.40.20/100		ER20	100	1-13	28	28	45520	50920	19212	-
11.455.40.20/160		ER20	160	1-13	28	28	45520	50920	19212	-
11.455.40.25/100		ER25	100	1-16	35	35	45525	50925	19216	-
11.455.40.25/160		ER25	160	1-16	35	35	45525	50925	19216	-

\* SUPPLIED WITHOUT WRENCH / \* GELIEFERT OHNE SCHLÜSSEL

REF.	ACCESSORIES / ZUBEHÖR
ERXX	Collets double slot DIN 6499 - Form B (ER) / Spannzangen mit Doppelnut DIN 6499 - Form B (ER)
ERCXX	Sealed collets DIN 6499 (ER) / Abgedichtete Spannzangen DIN 6499 (ER)
ERTXX	Collets DIN 6499 - Form Canela (ER) / Spannzangen DIN 6499 - Form Canela (ER)



ERXX



ERCXX



ERTXX

For more information see page / Für weitere Informationen siehe Seite: K.13, K.17, K.19

11 13  
DIN 69871-A

16  
HSK DIN 69893-

17  
TS ISO 26622-1

18  
PSC ISO 26623-1

20 23  
JIS B 6339-BT

25  
CHIRON





BORING HEADS  
BOHRKÖPFE

MORSE SHANKS  
MORSE SCHÄFTE

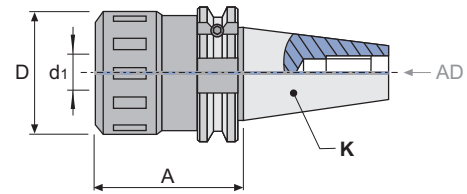
CYLINDRICAL SHANKS  
ZYLINDRISCHE SCHÄFTE

ACCESSORIES  
ZUBEHÖR



REF.	K ISO		A mm	d <sub>1</sub> mm	D mm				
11.457.40.32	40	ER32	80	2-20	54	45732	19006	50704	1,420
11.457.50.32	50	ER32	110	2-20	54	45732	19006	50704	3,580
11.457.50.40		ER40	120	3-30	65	45740	19010	50706	4,480

The alternative to hydraulic or other systems.  
High tightening and precision.  
Central coolant supply.

Die Alternative zu hydraulischen und anderen Systemen.  
Hohes Anzugsmoment und hohe Genauigkeit.  
Kühlmittel durch die Mitte.

\* SUPPLIED WITH WRENCH / \* GELIEFERT MIT SCHLÜSSEL

REF.	ACCESSORIES / ZUBEHÖR
ERXX	Collets double slot DIN 6499 - Form B (ER) / Spannzangen mit Doppelnut DIN 6499 - Form B (ER)
ERCXX	Sealed collets DIN 6499 (ER) / Abgedichtete Spannzangen DIN 6499 (ER)









ERXX

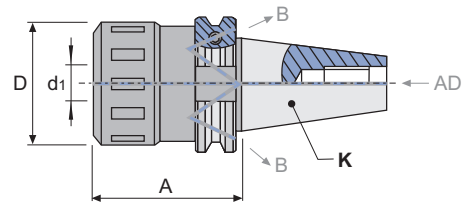

ERCXX

For more information see page / Für weitere Informationen siehe Seite: K.13, K.17



REF.	K ISO		A mm	d <sub>1</sub> mm	D mm				
13.457.40.32	40	ER32	80	2-20	54	45732	19006	50704	1,420
13.457.50.32	50	ER32	110	2-20	54	45732	19006	50704	3,560
13.457.50.40		ER40	120	3-30	65	45740	19010	50706	4,530

The alternative to hydraulic or other systems.  
 High tightening and precision.  
 Central coolant supply.

Die Alternative zu hydraulischen und anderen Systemen.  
 Hohes Anzugsmoment und hohe Genauigkeit.  
 Kühlmittel durch die Mitte.

\* SUPPLIED WITH WRENCH / \* GELIEFERT MIT SCHLÜSSEL

REF.	ACCESSORIES / ZUBEHÖR
ERXX	Collets double slot DIN 6499 - Form B (ER) / Spannzangen mit Doppelnut DIN 6499 - Form B (ER)
ERCXX	Sealed collets DIN 6499 (ER) / Abgedichtete Spannzangen DIN 6499 (ER)



ERXX



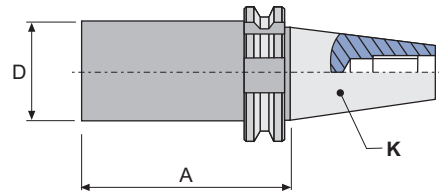

ERCXX

For more information see page / Für weitere Informationen siehe Seite: K.13, K.17

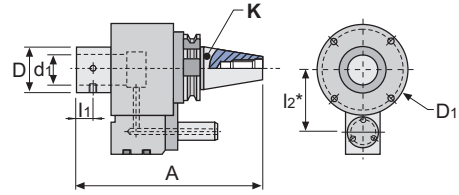

REF.	K ISO	D mm	A mm	kg
11.470.30.40	30	40,5	160	1,940
11.470.40.40	40	40,5	100	1,680
11.470.40.40/160		40,5	160	2,310
11.470.40.50		50,5	100	2,130
11.470.40.50/200		50,5	200	3,700
11.470.40.63		63,5	160	4,200
11.470.40.63/250		63,5	250	6,450
11.470.50.40	50	40,5	100	3,700
11.470.50.40/160		40,5	160	4,250
11.470.50.50		50,5	100	4,070
11.470.50.50/200		50,5	200	5,660
11.470.50.63		63,5	200	7,310
11.470.50.63/315		63,5	315	10,190
11.470.50.95		95,5	200	12,700
11.470.50.95/315		95,5	315	19,000



REF.	K ISO	d <sub>1</sub> G6 mm	A mm	D mm	D <sub>1</sub> mm	l <sub>1</sub> mm	l <sub>2</sub> * mm		
11.512.40.25	40	25	152	45	95	15	65	14116	5,150
11.512.40.32		32	152	48	95	16	65	14116	-
11.512.50.32	50	32	152	48	95	16	80	14116	7,550
11.512.50.40		40	166	58	110	17	80	14116	7,680

**rpm<sub>max</sub> 4.000 min.<sup>-1</sup> ± 25 bar<sub>max</sub>**

*\* Other sizes are manufactured under order.  
\* Andere Größen werden auf Antrag hergestellt.*

**COMPLEMENTS OF 512 GROUP / ZUBEHÖR VON GRUPPE 512**

REF.
512.00.00

REF.	D mm	d mm	D <sub>1</sub> mm	L mm
512.25.16	25	16	33	60
512.25.20		20	33	60
512.32.16	32	16	40	60
512.32.20		20	40	60
512.32.25		25	40	60
512.40.16	40	16	48	60
512.40.20		20	48	60
512.40.25		25	48	60
512.40.32		32	48	60

11 13  
DIN 69871-A

16  
HSK DIN 69833-

17  
TS ISO 26622-1

18  
PSC ISO 26623-1

20 23  
JIS B 6339-BT

25  
CHIRON

BORING HEADS  
BOHRKÖPFE

MORSE SHANKS  
MORSE SCHÄFTE

CYLINDRICAL SHANKS  
ZYLINDRISCHE SCHÄFTE

ACCESSORIES  
ZUBEHÖR





**TAPPING HEAD WITH AXIAL COMPENSATION**

hold tape with DIN 6499 (ER) collets and with inner coolant

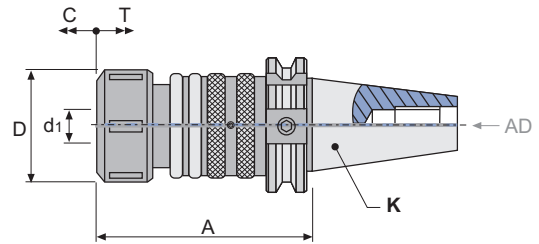
**GEWINDESCHNEIDFUTTER MIT LÄNGENAUSGLEICH**

Befestigung mit Spannzangen 6499 (ER), und mit Innenkühlung



REF.	K ISO			d <sub>1</sub>	A mm	D mm	C mm	T mm			
11.610.30.16	30	ER16	M3-M12		99	28	5,5	6,0	45316	50216	-
11.610.40.16	40	ER16	M3-M12		100	28	5,5	6,0	45316	50216	1,300
11.610.40.25		ER25	M4-M20		125	42	10,5	7,5	45325	50225	1,690
11.610.40.40		ER40	M8-M33		141	63	10,0	10,0	45340	50240	-
11.610.50.16	50	ER16	M3-M12		100	28	5,5	6,0	45316	50216	3,620
11.610.50.25		ER25	M4-M20		134	42	10,5	7,5	45325	50225	-
11.610.50.40		ER40	M8-M33		150	63	10,0	10,0	45340	50240	4,520

Compensation in compression (C) and tension (T).  
Compression can be blocked by turning the rear ring (A).  
Control of threading depth.  
Central coolant supply.

Ausgleich der Kompression (C) und der Traktion (T).  
Die Kompression kann mit dem Ring (A) blockiert werden.  
Kontrolle der Gewindetiefe.  
Kühlmittel durch die Mitte.

\* SUPPLIED WITH WRENCH / \* GELIEFERT MIT SCHLÜSSEL

REF.	ACCESSORIES / ZUBEHÖR
ERXX	Collets double slot DIN 6499 - Form B (ER) / Spannzangen mit Doppelnut DIN 6499 - Form B (ER)
ERCXX	Sealed collets DIN 6499 (ER) / Abgedichtete Spannzangen DIN 6499 (ER)
ERTXX	Collets DIN 6499 - Form Canela (ER) / Spannzangen DIN 6499 - Form Canela (ER)
40.453..	Collet chucks for DIN 6499 (ER) collets / Spannzangenfutter für DIN 6499 (ER) Spannzangen
40.455..	Long collet chucks for DIN 6499 (ER) collets / Lange Spannzangenfutter für DIN 6499 (ER) Spannzangen



ERXX



ERCXX



ERTXX



40.453..





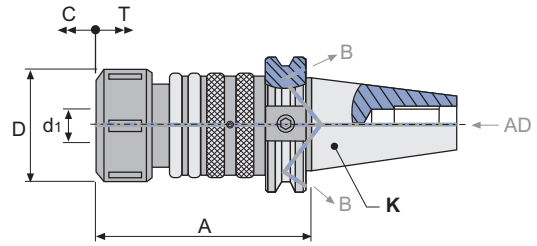

40.455..

For more information see page / Für weitere Informationen siehe Seite: K.13, K.17, K.19, J.08, J.09





REF.	K ISO			d <sub>1</sub>	A mm	D mm	C mm	T mm			
13.610.40.16	40	ER16	M3-M12	100	28	5,5	6,0	45316	50216	-	-
13.610.40.25		ER25	M4-M20	125	42	10,5	7,5	45325	50225	-	-
13.610.40.40		ER40	M8-M33	141	63	10,0	10,0	45340	50240	-	-
13.610.50.16	50	ER16	M3-M12	100	28	5,5	6,0	45316	50216	3,480	-
13.610.50.25		ER25	M4-M20	134	42	10,5	7,5	45325	50225	-	-
13.610.50.40		ER40	M8-M33	150	63	10,0	10,0	45340	50240	-	-

Compensation in compression (C) and tension (T).  
 Compression can be blocked by turning the rear ring (A).  
 Control of threading depth.  
 Central coolant supply.

Ausgleich der Kompression (C) und der Traktion (T).  
 Die Kompression kann mit dem Ring (A) blockiert werden.  
 Kontrolle der Gewindetiefe.  
 Kühlmittel durch die Mitte.

**\* SUPPLIED WITH WRENCH / \* GELIEFERT MIT SCHLÜSSEL**

REF.	ACCESSORIES / ZUBEHÖR
ERXX	Collets double slot DIN 6499 - Form B (ER) / Spannzangen mit Doppelnut DIN 6499 - Form B (ER)
ERCXX	Sealed collets DIN 6499 (ER) / Abgedichtete Spannzangen DIN 6499 (ER)
ERTXX	Collets DIN 6499 - Form Canela (ER) / Spannzangen DIN 6499 - Form Canela (ER)
40.453..	Collet chucks for DIN 6499 (ER) collets / Spannzangenfutter für DIN 6499 (ER) Spannzangen
40.455..	Long collet chucks for DIN 6499 (ER) collets / Lange Spannzangenfutter für DIN 6499 (ER) Spannzangen



ERXX



ERCXX



ERTXX



40.453..



40.455..

For more information see page / Für weitere Informationen siehe Seite: K.13, K.17, K.19, J.09, J.10

11 13  
DIN 69871-A  
16  
HSK DIN 69893-1  
17  
TS ISO 26622-1  
18  
PSC ISO 26623-1  
20 23  
JIS B 6339-BT  
25  
CHIRON  
BORING HEADS  
BOHRKÖPFE  
MORSE SHANKS  
MORSE SCHÄFTE  
CYLINDRICAL SHANKS  
ZYLINDRISCHE SCHÄFTE  
ACCESSORIES  
ZUBEHÖR





**CANELA****QUICK CHANGE TAPPING HEAD WITH AXIAL COMPENSATION**

with tap chucks bushings system Bilz

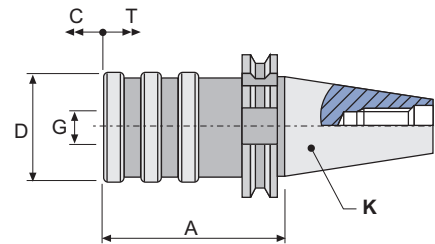
**GEWINDESCHNEID-SCHNELLWECHSELFUTTER MIT LÄNGENAUSGLEICH**

Mit Schnellwechseleinsätze Bilz-System

**DIN 69871-A****11.620**

REF.	K ISO	G N <sup>o</sup> . Ø		A mm	D mm	C mm	T mm			
11.620.30.12	30	1 19	M3-M12	63	38	9	9	710XX	750XX	0,620
11.620.40.12	40	1 19	M3-M12	68	38	9	9	710XX	750XX	1,060
11.620.40.20		2 31	M8-M20	93	55	15	15	720XX	760XX	1,660
11.620.40.33		3 48	M14-M33	138	79	24	24	730XX	770XX	3,490
11.620.50.12	50	1 19	M3-M12	80	38	9	9	710XX	750XX	2,960
11.620.50.20		2 31	M8-M20	102	55	15	15	720XX	760XX	3,410
11.620.50.33		3 48	M14-M33	135	79	24	24	730XX	770XX	5,110

COMPENSATION IN COMPRESSION (C) AND TENSION (T)  
AUSGLEICH DER KOMPRESSIION (C) UND DER TRAKTION (T)

REF.	ACCESSORIES / ZUBEHÖR
710XX..730XX	Quick change adapters without overload clutch / Schnellwechseleinsätze ohne Sicherheitskupplung
750XX..770XX	Quick change adapters with overload clutch / Schnellwechseleinsätze mit Sicherheitskupplung







710XX..730XX

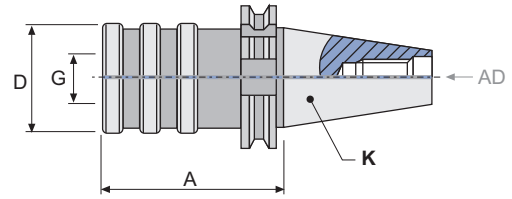

750XX..770XX

For more information see page / Für weitere Informationen siehe Seite: K.06, K.07



REF.	K ISO	G N <sup>o</sup> . Ø		A mm	D mm			
11.630.30.12	30	1 19	M3-M12	60	33	710XX	750XX	-
11.630.40.12	40	1 19	M3-M12	67	33	710XX	750XX	1,040
11.630.40.20		2 31	M8-M20	90	50	720XX	760XX	1,510
11.630.40.33		3 48	M14-M33	117	72	730XX	770XX	-
11.630.50.12	50	1 19	M3-M12	78	33	710XX	750XX	-
11.630.50.20		2 31	M8-M20	101	50	720XX	760XX	3,830
11.630.50.33		3 48	M14-M33	125	72	730XX	770XX	-

WITH INNER COOLANT  
MIT INNENKÜHLUNG

REF.	ACCESSORIES / ZUBEHÖR
710XX..730XX	Quick change adapters without overload clutch / Schnellwechseleinsätze ohne Sicherheitskupplung
750XX..770XX	Quick change adapters with overload clutch / Schnellwechseleinsätze mit Sicherheitskupplung





710XX..730XX

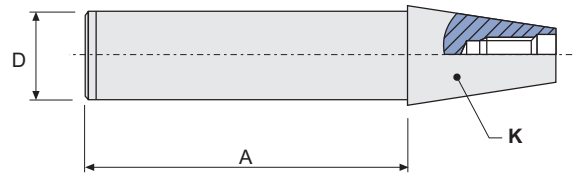

750XX..770XX

For more information see page / Für weitere Informationen siehe Seite: K.06, K.07



REF.	K ISO	A	D	
11.999.30	30	300	32	-
11.999.40	40	300	40	-
11.999.50	50	300	50	-

**1 TYPE / TYP**

11.160	11.165	11.180	11.210	11.215	11.216	11.225	11.226	11.290
11.295	11.296	11.300	11.302	11.305	11.353	11.400	11.453	11.455
11.457	11.470	11.512	11.610	11.620	11.630	A11.160	A11.160	A11.315
13.160	13.210	13.215	13.296	13.297	13.300	13.302	13.306	13.307
13.315	13.453	13.457	13.610					

**2 DIMENSION / ABMESSUNG**

<b>30</b>	<b>35</b>	<b>40</b>	<b>45</b>	<b>50</b>	<b>60</b>
-----------	-----------	-----------	-----------	-----------	-----------

**3 LENGTH (A) / LÄNGE (A)**

---

---

---

---

---

DIAMETER / DURCHMESSER	MK	ISO	COLLET SPANNZANGE

NOTES: \_\_\_\_\_

\_\_\_\_\_

\_\_\_\_\_

\_\_\_\_\_

\_\_\_\_\_

11 13  
DIN 69871-A  
  
 16  
HSK DIN 69833-1  
  
 17  
TS ISO 26622-1  
  
 18  
PSC ISO 26623-1  
  
 20 23  
JIS B 6339-BT  
  
 25  
CHIRON  
  
 BORING HEADS  
BOHRKÖPFE  
  
 MORSE SHANKS  
MORSE SCHÄFTE  
  
 CYLINDRICAL SHANKS  
ZYLINDRISCHE SCHÄFTE  
  
 ACCESSORIES  
ZUBEHÖR

## MANUFACTURED FROM FORGED PARTS

## MATERIAL:

- Alloyed carburized steel at chrome-manganese 1.7131 (16MnCr5).

## EXECUTION:

- Carburized, hardness.  
- Surface hardness HRC 58±2 (670±40 HV30)  
- Depth minimum 0,5 mm.  
- Tensile strength in core minimum 800 N/mm<sup>2</sup> after carburizing.

## ACCURACY:

- Taper according to DIN 254  
- Taper angle:  
tolerance AT 3 DIN 7178 part 1 and DIN 2080 part 1.  
- Other tolerances according to DIN 7160 and 7168.  
- Taper surface roughness  $R_z < 0,001$  mm.

K	AT 3 mm
ISO 30	0,002
ISO 40	0,003
ISO 45	0,003
ISO 50	0,004
ISO 60	0,005

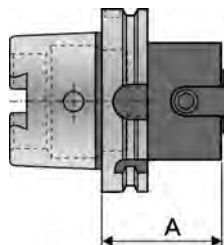

## HERGESTELLT AUS GESCHMIEDETEN TEILEN

## MATERIAL:

- Legierter Aufgekohlter Stahl mit Chrom-Mangan 1.7131 (16MnCr5).

## KONSTRUKTIONS DATEN:

- Aufgekohlt, gehärtet und angelassen.  
- Oberflächenhärte HRC 58±2 (670±40 HV30).  
- Aufgekohlt auf minimum 0,5 mm Tiefe.  
- Zugfestigkeit im Kern minimum 800 N/mm<sup>2</sup> nach der Aufkohlung.

## GENAUIGKEIT:

- Dorn nach DIN 254.  
- Kegelwinkel:  
Toleranz AT 3 DIN 7178 Teil 1 und DIN 2080 Teil 1.  
- Andere Toleranzen entsprechend DIN 7160 und 7168.  
- Rauigkeit der Oberfläche  $R_z < 0,001$  mm.

PORTAHERRAMIENTAS  
PRE-EQUILIBRADOSPREBALANCED  
TOOLHOLDERS

ISO 40 ► 8000 rpm ISO 50 ► 8000 rpm

## TOLERANCE AT :

- Indicates the tolerance of size D surface between the real and the theoretical value of the taper conicity.  
- This value of surface D must always be less (negative), never more (positive) in order to GUARANTEE a good toolholder fixation at the bigger taper diameter.

## TOLERANZ AT :

- Zeigt die Toleranz auf der Messebene D zwischen dem tatsächlichen Wert der Kegelkonizität und dem theoretischen Wert.  
- Dieser Wert auf der Messebene D sollte immer minus (negativ) sein, nie plus (positiv), um für einen guten Halt des Feeders in den größeren Durchmesser des Kegels zu garantieren.

## 16

## DIN 69893-HSK-A

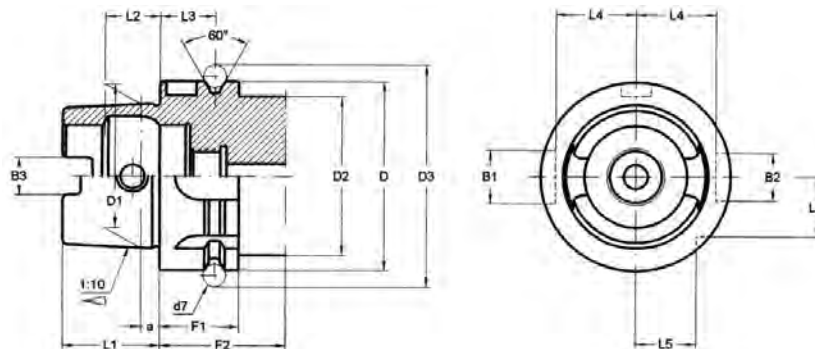

HSK	Dh10 mm	D1 mm	D2 max mm	D3 <sub>-0,1</sub> mm	B1 H10 mm	B2 H10 mm	B3±0,4 mm	d7 mm
32	32	24	26	37,0	9	7	7,05	4
40	40	30	34	45,0	11	9	8,05	4
50	50	38	42	59,3	14	12	10,54	7
63	63	48	53	72,3	18	16	12,54	7
80	80	60	67	88,8	20	18	16,04	7
100	100	75	85	109,75	22	20	20,02	7

HSK	L1 <sub>-0,2</sub> mm	L2 JS10 mm	L3±0,1 mm	L4 <sub>-0,2</sub> mm	L5 <sub>-0,3</sub> mm	F1 <sub>-0,1</sub> mm	F2 min mm	a mm
32	16	8,92	16	13,0	9,5	20	35	3,2
40	20	11,42	16	17,0	12,0	20	35	4,0
50	25	14,13	18	21,0	15,5	26	42	5,0
63	32	18,13	18	26,5	20,0	26	42	3,3
80	40	22,85	18	34,0	25,0	26	42	8,0
100	50	28,56	20	44,0	31,5	29	45	10,0

<p><b>16.160</b></p>  <p>C.02</p>	<p><b>16.180</b></p>  <p>C.03</p>	<p><b>16.210</b></p>  <p>C.04</p>	<p><b>16.215</b></p>  <p>C.05</p>	<p><b>16.296</b></p>  <p>C.06</p>
<p><b>16.300</b></p>  <p>C.07</p>	<p><b>16.305</b></p>  <p>C.08</p>	<p><b>16.315</b></p>  <p>C.09</p>	<p><b>16.453</b></p>  <p>C.10</p>	<p><b>16.455</b></p>  <p>C.11</p>
<p><b>16.470</b></p>  <p>C.12</p>	<p><b>16.999</b></p>  <p>C.12</p>			

16  
HSK DIN 69893-1

17  
TS ISO 26622-1

18  
PSC ISO 26623-1

20 23  
JIS B 6339-BT

25  
CHIRON

BORING HEADS  
BOHRKÖPFE

MORSE SHANKS  
MORSE SCHÄFTE

CYLINDRICAL SHANKS  
ZYLINDRISCHE SCHÄFTE

ACCESSORIES  
ZUBEHÖR



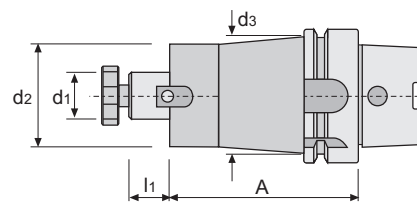
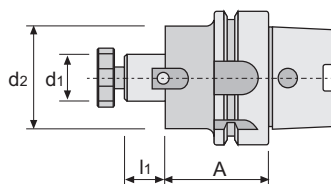

**CANELA**

**SHELL MILL ADAPTORS**  
for cutters with driving slot DIN 138  
**AUFSTECKFRÄSDORNE**  
für Fräser mit Quernut DIN 138



**DIN 69893-1****HSK Form A****16.160**

REF.	HSK	d <sub>1</sub> mm	d <sub>2</sub> mm	A mm	l <sub>1</sub> mm	d <sub>3</sub> mm	
16.160.050.16	50	16	38	50	17	-	-
16.160.050.22		22	48	50	19	-	-
16.160.050.27		27	58	60	21	-	-
16.160.063.16	63	16	38	50	17	-	-
16.160.063.16/100		16	38	100	17	46	-
16.160.063.16/160		16	38	160	17	46	-
16.160.063.22		22	48	50	19	-	-
16.160.063.22/100		22	48	100	19	53	-
16.160.063.22/160		22	48	160	19	53	-
16.160.063.27		27	58	60	21	-	-
16.160.063.27/100		27	58	100	21	-	-
16.160.063.27/160		27	58	160	21	-	-
16.160.063.32		32	64	60	24	-	-
16.160.063.32/100		32	64	100	24	-	-
16.160.063.32/160		32	64	160	24	-	-
16.160.063.40		40	80	60	27	-	-
16.160.063.40/100		40	80	100	27	-	-
16.160.100.16	100	16	38	50	17	-	-
16.160.100.22		22	48	50	19	-	-
16.160.100.27		27	55	50	21	-	-
16.160.100.32		32	64	50	24	-	-
16.160.100.40		40	80	60	27	-	-

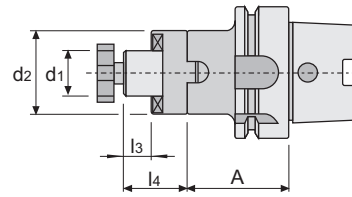
REF.			
16.160.050.16	10008	86016	11103
16.160.050.22	10010	86022	11004
16.160.050.27	10012	86027	11005
16.160.063.16	10008	86016	11103
16.160.063.16/100	10008	86016	11103
16.160.063.16/160	10008	86016	11103
16.160.063.22	10010	86022	11004
16.160.063.22/100	10010	86022	11004
16.160.063.22/160	10010	86022	11004
16.160.063.27	10012	86027	11005
16.160.063.27/100	10012	86027	11005
16.160.063.27/160	10012	86027	11005
16.160.063.32	10016	86032	11105
16.160.063.32/100	10016	86032	11105
16.160.063.32/160	10016	86032	11105
16.160.063.40	10020	86040	11006
16.160.063.40/100	10020	86040	11006
16.160.100.16	10008	86016	11103
16.160.100.22	10010	86022	11004
16.160.100.27	10012	86027	11005
16.160.100.32	10016	86032	11105
16.160.100.40	10020	86040	11006



REF.	HSK	d <sub>1</sub> h6 mm	A mm	l <sub>3</sub> mm	l <sub>4</sub> mm	d <sub>2</sub> mm	⚖ kg
16.180.063.16	63	16	55	17	27	32	-
16.180.063.16/100		16	100	17	27	32	-
16.180.063.22		22	55	19	31	40	-
16.180.063.22/100		22	100	19	31	40	-
16.180.063.27		27	55	21	33	48	-
16.180.063.27/100		27	100	21	33	48	-
16.180.063.32		32	60	24	38	58	-
16.180.063.32/100		32	100	24	38	58	-
16.180.063.40		40	60	27	41	70	2,110
16.180.063.40/100		40	100	27	41	70	-
16.180.100.16	100	16	55	17	27	32	-
16.180.100.16/100		16	100	17	27	32	-
16.180.100.22		22	55	19	31	40	2,500
16.180.100.22/100		22	100	19	31	40	-
16.180.100.27		27	55	21	33	48	-
16.180.100.27/100		27	100	21	33	48	-
16.180.100.32		32	60	24	38	58	-
16.180.100.32/100		32	100	24	38	58	-
16.180.100.40		40	60	27	41	70	-
16.180.100.40/100		40	100	27	41	70	-

REF.			
16.180.063.16	10008	60116	88016
16.180.063.16/100	10008	60116	88016
16.180.063.22	10010	60122	88022
16.180.063.22/100	10010	60122	88022
16.180.063.27	10012	60127	88027
16.180.063.27/100	10012	60127	88027
16.180.063.32	10016	60132	88032
16.180.063.32/100	10016	60132	88032
16.180.063.40	10020	60140	88040
16.180.063.40/100	10020	60140	88040
16.180.100.16	10008	60116	88016
16.180.100.16/100	10008	60116	88016
16.180.100.22	10010	60122	88022
16.180.100.22/100	10010	60122	88022
16.180.100.27	10012	60127	88027
16.180.100.27/100	10012	60127	88027
16.180.100.32	10016	60132	88032
16.180.100.32/100	10016	60132	88032
16.180.100.40	10020	60140	88040
16.180.100.40/100	10020	60140	88040

**REDUCING ADAPTORS**



for tools with Morse taper shank and drawbar thread DIN 228-A

**REDUZIERHÜLSEN**

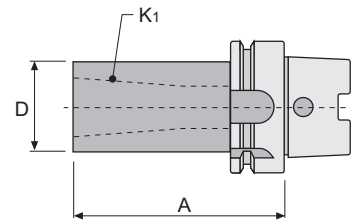
für Werkzeuge mit Morsekegel und Anzugsgewinde DIN 228-A



REF.	HSK	K1 MORSE	A mm	D mm	kg
16.210.050.01	50	1	100	25	-
16.210.050.02		2	120	32	-
16.210.050.03		3	140	40	-
16.210.063.01	63	1	100	25	-
16.210.063.02		2	120	32	-
16.210.063.03		3	140	40	-
16.210.063.04		4	160	48	-
16.210.100.02	100	2	120	32	-
16.210.100.03		3	150	40	-
16.210.100.04		4	170	48	-
16.210.100.05		5	200	63	-

REF.			
16.210.050.01	16205	19624	18006
16.210.050.02	16205	19324	18110
16.210.050.03	16205	19524	18112
16.210.063.01	16205	19624	18006
16.210.063.02	16205	19324	18110
16.210.063.03	16205	19524	18112
16.210.063.04	16205	19424	18016
16.210.100.02	16205	19324	18110
16.210.100.03	16205	19524	18112
16.210.100.04	16205	19424	18016
16.210.100.05	16205	19338	18020

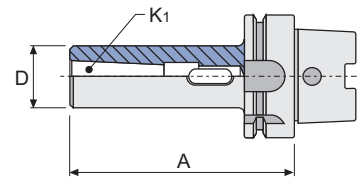

REF.	HSK	K1 MORSE	A mm	D mm	
16.215.050.01	50	1	100	25	-
16.215.050.02		2	120	32	-
16.215.050.03		3	140	40	-
16.215.063.01	63	1	100	25	-
16.215.063.02		2	120	32	-
16.215.063.03		3	140	40	-
16.215.063.04		4	160	48	-
16.215.100.02	100	2	120	32	-
16.215.100.03		3	150	40	-
16.215.100.04		4	170	48	-
16.215.100.05		5	200	63	-

16  
HSK DIN 69893-1

17  
TS ISO 26622-1

18  
PSC ISO 26623-1

20 23  
JIS B 6339-BT

25  
CHIRON

BORING HEADS  
BOHRKÖPFE

MORSE SHANKS  
MORSE SCHÄFTE

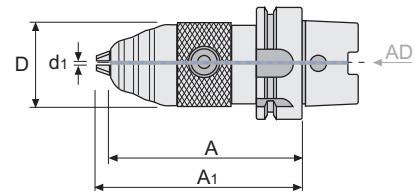

CYLINDRICAL SHANKS  
ZYLINDRISCHE SCHÄFTE

ACCESSORIES  
ZUBEHÖR





REF.	HSK	d <sub>1</sub> mm	D mm	A mm	A <sub>1</sub> max mm	
16.296.050.13	50	1-13	50	86,4	93,4	-
16.296.050.16		3-16	56	96,4	103,4	-
16.296.063.13	63	1-13	50	89,4	96,4	-
16.296.063.16		3-16	56	96,4	103,4	-
16.296.100.13	100	1-13	50	100,4	107,4	-
16.296.100.16		3-16	56	107,4	114,4	-

\* SUPPLIED WITH WRENCH / \* GELIEFERT MIT SCHLÜSSEL

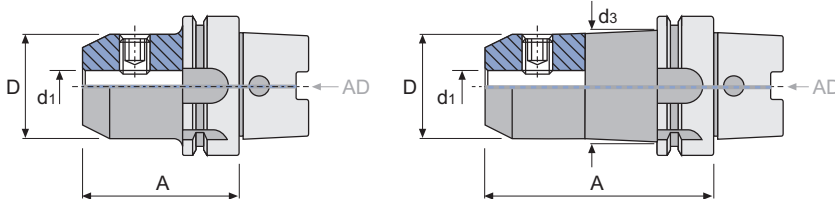
REF.		3 x 
16.296.050.13	50706	60313
16.296.050.16	50706	60313
16.296.063.13	50706	60313
16.296.063.16	50706	60313
16.296.100.13	50706	60313
16.296.100.16	50706	60313





REF.	HSK	d <sub>1</sub> mm	A mm	D mm	d <sub>3</sub> mm		 kg
16.300.050.06	50	6	65	25	-	15106	-
16.300.050.08		8	65	28	-	15108	-
16.300.050.10		10	65	35	-	15110	-
16.300.050.12		12	80	42	-	15212	-
16.300.050.14		14	80	44	-	15212	-
16.300.050.16		16	80	48	-	15314	-
16.300.050.18		18	80	50	-	15314	-
16.300.050.20		20	80	52	-	15216	-
16.300.063.06	63	6	65	25	-	15106	-
16.300.063.06/160		6	160	25	30	15106	-
16.300.063.08		8	65	28	-	15108	-
16.300.063.08/160		8	160	28	32	15108	-
16.300.063.10		10	65	35	-	15110	-
16.300.063.10/160		10	160	35	32	15110	-
16.300.063.12		12	80	42	-	15212	-
16.300.063.12/160		12	160	42	45	15212	-
16.300.063.14		14	80	44	-	15212	-
16.300.063.14/160		14	160	44	48	15212	-
16.300.063.16		16	80	48	-	15314	-
16.300.063.16/160		16	160	48	52	15314	-
16.300.063.18		18	80	50	-	15314	-
16.300.063.18/160		18	160	50	52	15314	-
16.300.063.20		20	80	52	-	15216	-
16.300.063.20/160		20	160	52	-	15216	-
16.300.063.25		25	110	65	-	2 x 15218	2,310
16.300.063.25/160		25	160	65	-	2 x 15218	-
16.300.063.32	32	110	72	-	2 x 15220	-	
16.300.063.32/160	32	160	72	-	2 x 15220	-	
16.300.100.06	100	6	80	25	-	15106	-
16.300.100.06/160		6	160	25	30	15106	-
16.300.100.08		8	80	28	-	15108	-
16.300.100.08/160		8	160	28	32	15108	-
16.300.100.10		10	80	35	-	15110	-
16.300.100.10/160		10	160	35	32	15110	-
16.300.100.12		12	80	42	-	15212	-
16.300.100.12/160		12	160	42	45	15212	-
16.300.100.14		14	80	44	-	15212	-
16.300.100.14/160		14	160	44	48	15212	-
16.300.100.16		16	100	48	-	15314	-
16.300.100.16/160		16	160	48	52	15314	-
16.300.100.18		18	100	50	-	15314	-
16.300.100.18/160		18	160	50	52	15314	-
16.300.100.20		20	100	52	-	15216	-
16.300.100.20/160		20	160	52	-	15216	-
16.300.100.25		25	100	65	-	2 x 15218	-
16.300.100.25/160		25	160	65	-	2 x 15218	-
16.300.100.32		32	100	72	-	2 x 15220	-
16.300.100.32/160		32	160	72	-	2 x 15220	-
16.300.100.40	40	100	80	-	2 x 15024	-	
16.300.100.40/160	40	160	80	-	2 x 15024	-	

ACCESSORIES / ZUBEHÖR 42.300 - 42.311: For more information see page / Für weitere Informationen siehe Seite: J.11, J.12

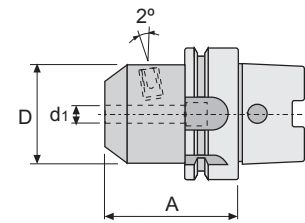
16 HSK DIN 69893-1  
17 TS ISO 26622-1  
18 PSC ISO 26623-1  
20 23 JIS B 6339-BT  
25 CHIRON  
BORING HEADS  
BOHRKÖPFE  
MORSE SHANKS  
MORSE SCHÄFTE  
CYLINDRICAL SHANKS  
ZYLINDRISCHE SCHÄFTE  
ACCESSORIES  
ZUBEHÖR



REF.	HSK	d <sub>1</sub> H4 mm	A mm	D mm			
16.305.050.06	50	6	80	25	19005	15106	-
16.305.050.08		8	80	28	19106	15108	-
16.305.050.10		10	80	35	19008	15110	-
16.305.050.12		12	90	42	19110	15212	-
16.305.050.14		14	90	44	19110	15212	-
16.305.050.16		16	100	48	19012	15314	-
16.305.050.18		18	100	50	19012	15314	-
16.305.050.20	20	100	100	52	19016	15216	-
16.305.063.06	63	6	80	25	19005	15106	-
16.305.063.08		8	80	28	19106	15108	-
16.305.063.10		10	80	35	19008	15110	-
16.305.063.12		12	90	42	19110	15212	-
16.305.063.14		14	90	44	19110	15212	-
16.305.063.16		16	100	48	19012	15314	-
16.305.063.18		18	100	50	19012	15314	-
16.305.063.20		20	100	52	19016	15216	-
16.305.063.25		25	110	65	19020	15218	-
16.305.063.32		32	115	72	19020	15220	-
16.305.100.06	100	6	90	25	19005	15106	-
16.305.100.08		8	90	28	19106	15108	-
16.305.100.10		10	90	35	19008	15110	-
16.305.100.12		12	100	42	19110	15212	-
16.305.100.14		14	100	44	19110	15212	-
16.305.100.16		16	100	48	19012	15314	-
16.305.100.18		18	100	50	19012	15314	-
16.305.100.20		20	100	52	19016	15216	-
16.305.100.25		25	120	65	19020	15218	-
16.305.100.32		32	120	72	19020	15220	-
16.305.100.40		40	130	80	19020	15220	-



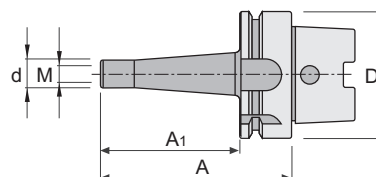

REF.	HSK	d mm	M mm	A mm	A <sub>1</sub> mm	D mm	⚠ kg
16.315.63.10/050	63	18	10	50	24	63	-
16.315.63.10/100		18	10	100	74	63	-
16.315.63.12/050		21	12	50	24	63	-
16.315.63.12/100		21	12	100	74	63	-
16.315.63.16/050		29	16	50	24	63	-
16.315.63.16/100		29	16	100	74	63	-
16.315.100.10/100	100	18	10	100	71	100	-
16.315.100.10/150		18	10	150	121	100	-
16.315.100.12/100		21	12	100	71	100	-
16.315.100.12/150		21	12	150	121	100	-
16.315.100.16/100		29	16	100	71	100	-
16.315.100.16/150		29	16	150	121	100	-

REF.	ACCESSORIES / ZUBEHÖR
06.315	Front contact extensions for modular tools. / Stirnverlängerung für Einschraubfräser.
06.315	Front contact reducers for modular tools. / Stirnreduzierhülsen für Einschraubfräser.



06.315



06.315

For more information see page / Für weitere Informationen siehe Seite: J.02, J.03

16  
HSK DIN 69893-1

17  
TS ISO 26622-1

18  
PSC ISO 26623-1

20 23  
JIS B 6339-BT

25  
CHIRON





BORING HEADS  
BOHRKÖPFE

MORSE SHANKS  
MORSE SCHÄFTE

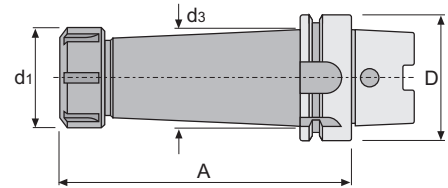
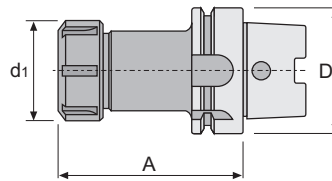
CYLINDRICAL SHANKS  
ZYLINDRISCHE SCHÄFTE

ACCESSORIES  
ZUBEHÖR



REF.	HSK		A mm	d <sub>1</sub> mm	D mm	d <sub>3</sub> mm				
16.453.050.16	50	ER16	100	0,5-10	32	-	45316	50216	19210	-
16.453.050.20		ER20	100	1-13	35	-	45320	50220	19212	-
16.453.050.25		ER25	100	1-16	42	-	45325	50225	19216	-
16.453.050.25/160		ER25	160	1-16	42	42	45325	50225	19216	-
16.453.050.32		ER32	100	2-20	50	-	45332	50232	19218	-
16.453.050.32/160		ER32	160	2-20	50	42	45332	50232	19218	-
16.453.050.40		ER40	100	3-30	63	-	45340	50240	19224	-
16.453.063.16	63	ER16	100	0,5-10	32	-	45316	50216	19210	-
16.453.063.16/160		ER16	160	0,5-10	32	32	45316	50216	19210	-
16.453.063.20		ER20	100	1-13	35	-	45320	50220	19212	-
16.453.063.20/160		ER20	160	1-13	35	35	45320	50220	19212	-
16.453.063.25		ER25	100	1-16	42	-	45325	50225	19216	-
16.453.063.25/160		ER25	160	1-16	42	42	45325	50225	19216	1,840
16.453.063.32		ER32	100	2-20	50	-	45332	50232	19218	1,470
16.453.063.32/160	ER32	160	2-20	50	50	45332	50232	19218	-	
16.453.063.40	ER40	100	3-30	63	-	45340	50240	19224	-	
16.453.063.40/160	ER40	160	3-30	63	-	45340	50240	19224	-	
16.453.100.16	100	ER16	100	0,5-10	32	-	45316	50216	19210	-
16.453.100.20		ER20	100	1-13	35	-	45320	50220	19212	-
16.453.100.25		ER25	100	1-16	42	-	45325	50225	19216	-
16.453.100.25/160		ER25	160	1-16	42	42	45325	50225	19216	-
16.453.100.32		ER32	100	2-20	50	-	45332	50232	19218	-
16.453.100.32/160		ER32	160	2-20	50	50	45332	50232	19218	-
16.453.100.40		ER40	100	3-30	63	-	45340	50240	19224	-
16.453.100.40/160	ER40	160	3-30	63	63	45340	50240	19224	-	

\* If you want with ball bearing nut, see page: K.22

\* Wenn Sie diese mit Kugellager-Nute möchten, siehe Seite: K.22

\* SUPPLIED WITHOUT WRENCH / \* GELIEFERT OHNE SCHLÜSSEL

REF.	ACCESSORIES / ZUBEHÖR
ERXX	Collets double slot DIN 6499 - Form B (ER) / Spannanzgen mit Doppelnut DIN 6499 - Form B (ER)
ERCXX	Sealed collets DIN 6499 (ER) / Abgedichtete Spannanzgen DIN 6499 (ER)
ERTXX	Collets DIN 6499 - Form Canela (ER) / Spannanzgen DIN 6499 - Form Canela (ER)
40.453..	Collet chucks for DIN 6499 (ER) collets / Spannanzgenfutter für DIN 6499 (ER) Spannanzgen
40.455..	Long collet chucks for DIN 6499 (ER) collets / Lange Spannanzgenfutter für DIN 6499 (ER) Spannanzgen



ERXX



ERCXX



ERTXX



40.453..





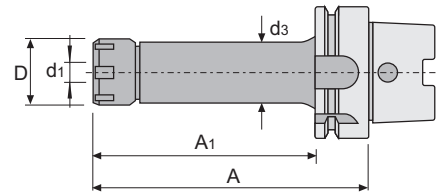

40.455..

For more information see page / Für weitere Informationen siehe Seite: K.13, K.17, K.19, J.08, J.09

WITH "MINI" COLLET NUT  
MIT "MINI"-SPANNMUTTER



REF.	HSK		d <sub>1</sub> mm	A mm	D mm	A <sub>1</sub> mm	d <sub>3</sub> mm				
16.455.063.16	63	ER16	0,5-10	100	22	-	-	45516	50916	19210	-
16.455.063.16/160		ER16	0,5-10	160	22	100	30	45516	50916	19210	-
16.455.063.20		ER20	1-13	100	28	-	-	45520	50920	19212	-
16.455.063.20/160		ER20	1-13	160	28	100	30	45520	50920	19212	-
16.455.063.25		ER25	1-16	100	35	-	-	45525	50925	19216	-
16.455.063.25/160		ER25	1-16	160	35	100	30	45525	50925	19216	-

\* SUPPLIED WITHOUT WRENCH / \* GELIEFERT OHNE SCHLÜSSEL

REF.	ACCESSORIES / ZUBEHÖR
ERXX	Collets double slot DIN 6499 - Form B (ER) / Spannzangen mit Doppelnut DIN 6499 - Form B (ER)
ERCXX	Sealed collets DIN 6499 (ER) / Abgedichtete Spannzangen DIN 6499 (ER)
ERTXX	Collets DIN 6499 - Form Canela (ER) / Spannzangen DIN 6499 - Form Canela (ER)



ERXX



ERCXX



ERTXX

For more information see page / Für weitere Informationen siehe Seite: K.13, K.17, K.19

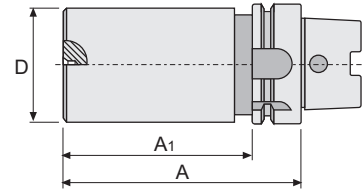

REF.	HSK	D mm	A <sub>1</sub> mm	A mm	kg
16.470.050.50/200	50	50	200	226	-
16.470.050.63/200		63	200	226	-
16.470.063.63/100	63	63	100	126	-
16.470.063.63/200		63	200	226	-
16.470.063.80/250		80	250	276	-
16.470.100.63/200	100	63	200	229	-
16.470.100.80/250		80	250	279	-
16.470.100.85/045		85	45	74	-
16.470.100.90/300		90	300	329	-

\* SUPPLIED WITHOUT WRENCH / \* GELIEFERT OHNE SCHLÜSSEL

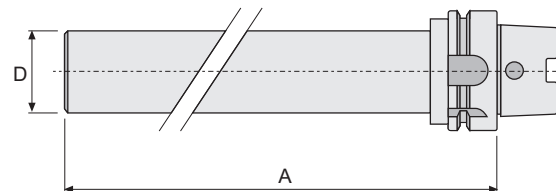
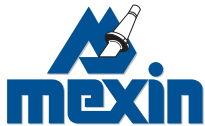

REF.	HSK	A	D	kg
16.999.050	50	300	40	-
16.999.063	63	300	40	-
16.999.100	100	300	50	-

**1 TYPE / TYP**

16.160 	16.180 	16.210 	16.215 
16.296 	16.300 	16.305 	16.315 
16.453 	16.455 	16.470 	

**2 DIMENSION / ABMESSUNG**

<b>32</b>	<b>40</b>	<b>50</b>	<b>63</b>	<b>80</b>	<b>100</b>
-----------	-----------	-----------	-----------	-----------	------------

**3 LENGTH (A) / LÄNGE (A)**



---

---

---

---

---

---

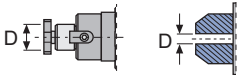
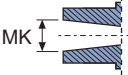
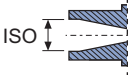
DIAMETER / DURCHMESSER	MK	ISO	COLLET SPANNZANGE
			

NOTES: \_\_\_\_\_

\_\_\_\_\_

\_\_\_\_\_

\_\_\_\_\_

\_\_\_\_\_

16 HSK DIN 69893-1  
 17 TS ISO 26692-1  
 18 PSC ISO 26623-1  
 20 23 JIS B 6339-BT  
 25 CHIRON  
 BORING HEADS BOHRKÖPFE  
 MORSE SHANKS MORSE SCHÄFTE  
 CYLINDRICAL SHANKS ZYLINDRISCHE SCHÄFTE  
 ACCESSORIES ZUBEHÖR

## MANUFACTURED FROM FORGED PARTS

## MATERIAL:

- Alloyed carburized steel at chrome-manganese 1.7131 (16MnCr5).

## EXECUTION:

- Carburized, hardness.
- Surface hardness HRC 58±2 (670±40 HV30)
- Depth minimum 0,5 mm.
- Tensile strength in core minimum 800 N/mm<sup>2</sup> after carburizing.

## ACCURACY:

- Taper according to DIN 254
- Taper angle:  
tolerance AT 3 DIN 7178 part 1 and DIN 2080 part 1.
- Other tolerances according to DIN 7160 and 7168.
- Taper surface roughness  $R_z < 0,001$  mm.

## HERGESTELLT AUS GESCHMIEDETEN TEILEN

## MATERIAL:

- Legierter Aufgekohlter Stahl mit Chrom-Mangan 1.7131 (16MnCr5).

## KONSTRUKTIONS DATEN:

- Aufgekohlt, gehärtet und angelassen.
- Oberflächenhärte HRC 58±2 (670±40 HV30).
- Aufgekohlt auf minimum 0,5 mm Tiefe.
- Zugfestigkeit im Kern minimum 800 N/mm<sup>2</sup> nach der Aufkohlung.

## GENAUIGKEIT:

- Dorn nach DIN 254.
- Kegelwinkel:  
Toleranz AT 3 DIN 7178 Teil 1 und DIN 2080 Teil 1.
- Andere Toleranzen entsprechend DIN 7160 und 7168.
- Rauigkeit der Oberfläche  $R_z < 0,001$  mm.

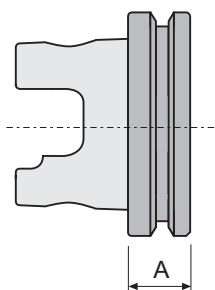

## TOLERANCE AT:

- Indicates the tolerance of size D surface between the real and the theoretical value of the taper conicity.
- This value of surface D must always be less (negative), never more (positive) in order to GUARANTEE a good toolholder fixation at the bigger taper diameter.

## TOLERANZ AT:

- Zeigt die Toleranz auf der Messebene D zwischen dem tatsächlichen Wert der Kegelkonizität und dem theoretischen Wert.
- Dieser Wert auf der Messebene D sollte immer minus (negativ) sein, nie plus (positiv), um für einen guten Halt des Futters in den größeren Durchmesser des Kegels zu garantieren.

17

ISO 26622-1

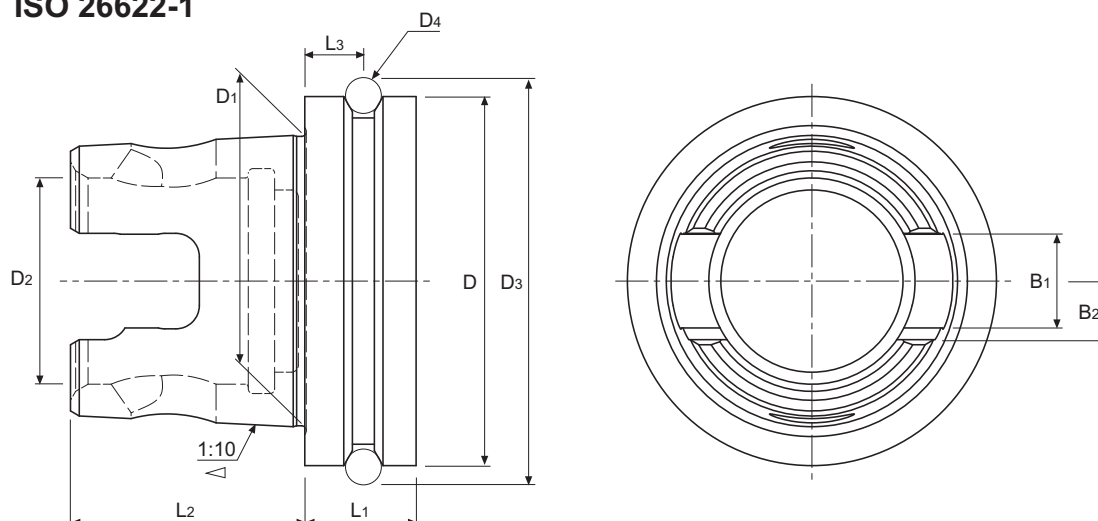

TS	D mm	D <sub>1</sub> mm	D <sub>2</sub> mm	D <sub>3</sub> mm	D <sub>4</sub> mm	L <sub>1</sub> min mm	L <sub>2</sub> mm	L <sub>3</sub> mm	B <sub>1</sub> mm
40	40	30	21,0	44,45	3,5	12	25	6	10
50	50	40	28,2	59,40	7,0	18	32	9	14
63	63	50	35,2	72,40	7,0	20	40	10	16
80	80	64	48,0	89,40	7,0	22	45	11	20
100	100	82	62,0	109,40	7,0	22	50	11	24



17  
TS ISO 26622-1

18  
PSC ISO 26623-1

20 23  
JIS B 6339-BT

25  
CHIRON

BORING HEADS  
BOHRKÖPFE

MORSE SHANKS  
MORSE SCHÄFTE



CYLINDRICAL SHANKS  
ZYLINDRISCHE SCHÄFTE

ACCESSORIES  
ZUBEHÖR

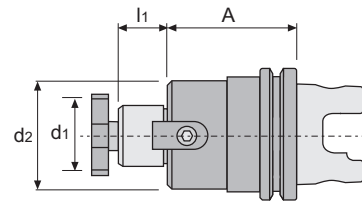



REF.	TS	d <sub>1</sub> h6 mm	A mm	l <sub>1</sub> mm	d <sub>2</sub> mm	kg
17.160.040.16	40	16	55	17	37	-
17.160.040.22		22	55	19	47	-
17.160.050.16	50	16	63	17	37	-
17.160.050.22		22	63	19	47	-
17.160.050.27		27	63	21	58	-
17.160.050.32		32	63	24	63	-
17.160.063.16	63	16	63	17	37	-
17.160.063.22		22	28	19	47	-
17.160.063.22/63		22	63	19	47	-
17.160.063.27		27	28	21	58	-
17.160.063.27/63		27	63	21	58	-
17.160.063.32		32	22	24	63	-
17.160.063.32/63		32	63	24	63	-
17.160.063.40		40	86	27	63	-

REF.			
17.160.040.16	10008	86016	11103
17.160.040.22	10010	86022	11004
17.160.050.16	10008	86016	11103
17.160.050.22	10010	86022	11004
17.160.050.27	10012	86027	11005
17.160.050.32	10016	86032	11105
17.160.063.16	10008	86016	11103
17.160.063.22	10010	86022	11004
17.160.063.22/63	10010	86022	11004
17.160.063.27	10012	86027	11005
17.160.063.27/63	10012	86027	11005
17.160.063.32	10016	86032	11105
17.160.063.32/63	10016	86032	11105
17.160.063.40	10020	86040	11006

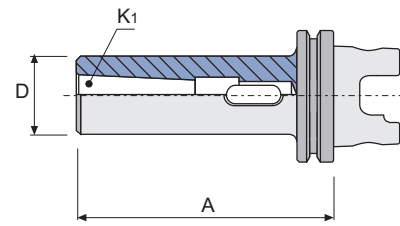

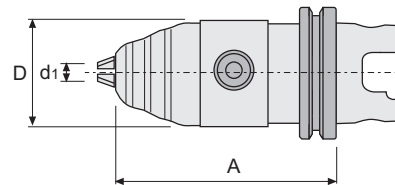

REF.	TS	K <sub>1</sub> MORSE	A mm	D mm	⚖️ kg
17.215.050.02	50	2	110	32	-
17.215.050.03		3	130	40	-
17.215.063.02	63	2	110	32	-
17.215.063.03		3	130	40	-
17.215.063.04		4	150	52	-

- 17  
TS ISO 26622-1
- 18  
PSC ISO 26623-1
- 20 23  
JIS B 6339-BT
- 25  
CHIRON
- BORING HEADS  
BOHRKÖPFE
- MORSE SHANKS  
MORSE SCHÄFTE
- CYLINDRICAL SHANKS  
ZYLINDRISCHE SCHÄFTE
- ACCESSORIES  
ZUBEHÖR





REF.	TS	D mm	d <sub>1</sub> mm	A mm	
17.296.040.13	40	50	0.5 - 13	112	-
17.296.050.13	50	50	0.5 - 13	112	-
17.296.063.13	63	50	0.5 - 13	112	-
17.296.063.16		57	3.0 - 16	112	-

\* SUPPLIED WITH WRENCH / \* GELIEFERT MIT SCHLÜSSEL

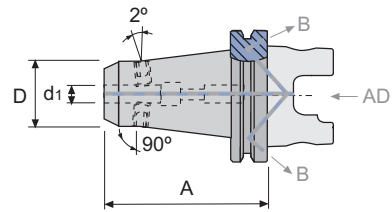
REF.		3 x 
17.296.040.13	50706	60313
17.296.050.13	50706	60313
17.296.063.13	50706	60313
17.296.063.16	50706	60313



REF.	TS	d1 mm	D mm	A mm	2 x 	
17.306.040.06	40	06	25	50	15006	-
17.306.040.08		08	28	50	15008	-
17.306.040.10		10	35	50	15010	-
17.306.040.12		12	42	55	15012	-
17.306.040.16		16	48	55	15114	-
17.306.050.06	50	06	25	55	15006	-
17.306.050.08		08	28	55	15008	-
17.306.050.10		10	35	65	15010	-
17.306.050.12		12	42	65	15012	-
17.306.050.14		14	42	65	15012	-
17.306.050.16		16	48	65	15114	-
17.306.050.18		18	48	65	15114	-
17.306.050.20		20	52	65	15116	-
17.306.050.25		25	65	80	4 x 15018	-
17.306.063.06	63	06	25	80	15006	-
17.306.063.08		08	28	80	15008	-
17.306.063.10		10	35	80	15010	-
17.306.063.12		12	42	80	15012	-
17.306.063.14		14	42	80	15012	-
17.306.063.16		16	48	80	15114	-
17.306.063.18		18	48	80	15114	-
17.306.063.20		20	52	80	15116	-
17.306.063.25		25	65	90	4 x 15018	-
17.306.063.32		32	72	90	4 x 15120	-
17.306.063.40		40	80	95	4 x 15120	-

17  
TS ISO 26622-1

18  
PSC ISO 26623-1

20 23  
JIS B 6339-BT

25  
CHIRON

BORING HEADS  
BOHRKÖPFE

MORSE SHANKS  
MORSE SCHÄFTE

CYLINDRICAL SHANKS  
ZYLINDRISCHE SCHÄFTE

ACCESSORIES  
ZUBEHÖR

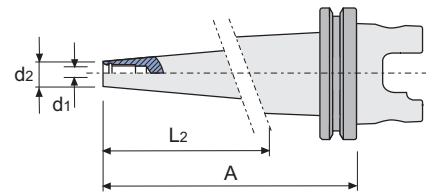

REF.	TS	A mm	d <sub>1</sub> mm	d <sub>2</sub> mm	L <sub>2</sub> mm	kg
17.315.040.08	40	70	M8	12,8	41,8	-
17.315.040.10		80	M10	17,8	52,4	-
17.315.040.12		80	M12	20,8	52,8	-
17.315.050.08	50	70	M8	12,8	40,4	-
17.315.050.10		80	M10	17,8	51,1	-
17.315.050.12		80	M12	20,8	51,5	-
17.315.050.16		80	M16	28,8	52,6	-
17.315.063.08	63	70	M8	12,8	35,1	-
17.315.063.10		90	M10	17,8	55,8	-
17.315.063.12		100	M12	20,8	66,2	-
17.315.063.16		100	M16	28,8	67,3	-

REF.	ACCESSORIES / ZUBEHÖR
06.315	Front contact extensions for modular tools. / Stirnverlängerung für Einschraubfräser.
06.315	Front contact reducers for modular tools. / Stirnreduzierhülsen für Einschraubfräser.









06.315

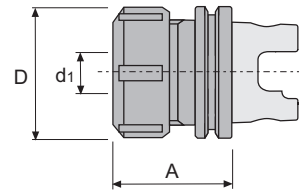

06.315

For more information see page / Für weitere Informationen siehe Seite: J.02, J.03



REF.	TS		A mm	d <sub>1</sub> mm	D mm				
17.453.040.16	40	ER16	60	0,5-10	28	45316	50216	19210	-
17.453.040.20		ER20	60	1-13	34	45320	50220	19212	-
17.453.040.25		ER25	60	1-16	42	45325	50225	19216	-
17.453.040.32		ER32	60	2-20	50	45332	50232	19218	-
17.453.050.16	50	ER16	60	0,5-10	28	45316	50216	19210	-
17.453.050.16/100		ER16	100	0,5-10	28	45316	50216	19210	-
17.453.050.20		ER20	60	1-13	34	45320	50220	19212	-
17.453.050.20/100		ER20	100	1-13	34	45320	50220	19212	-
17.453.050.25		ER25	60	1-16	42	45325	50225	19216	-
17.453.050.25/100		ER25	100	1-16	42	45325	50225	19216	-
17.453.050.32		ER32	60	2-20	50	45332	50232	19218	-
17.453.050.32/100		ER32	100	2-20	50	45332	50232	19218	-
17.453.050.40		ER40	65	3-30	63	45340	50240	19224	-
17.453.050.40/100		ER40	100	3-30	63	45340	50240	19224	-
17.453.063.16	63	ER16	60	0,5-10	28	45316	50216	19210	-
17.453.063.16/100		ER16	100	0,5-10	28	45316	50216	19210	-
17.453.063.20		ER20	60	1-13	34	45320	50220	19212	-
17.453.063.20/100		ER20	100	1-13	34	45320	50220	19212	-
17.453.063.25		ER25	60	1-16	42	45325	50225	19216	-
17.453.063.25/100		ER25	100	1-16	42	45325	50225	19216	-
17.453.063.32		ER32	60	2-20	50	45332	50232	19218	-
17.453.063.32/100		ER32	100	2-20	50	45332	50232	19218	-
17.453.063.40		ER40	65	3-30	63	45340	50240	19224	-
17.453.063.40/100		ER40	100	3-30	63	45340	50240	19224	-

*\* If you want with ball bearing nut, see page: K.22  
\* Wenn Sie diese mit Kugellager-Nute möchten, siehe Seite: K.22*

**\* SUPPLIED WITHOUT WRENCH / \* GELIEFERT OHNE SCHLÜSSEL**

REF.	ACCESSORIES / ZUBEHÖR
ERXX	Collets double slot DIN 6499 - Form B (ER) / Spannanzgen mit Doppelnut DIN 6499 - Form B (ER)
ERCXX	Sealed collets DIN 6499 (ER) / Abgedichtete Spannanzgen DIN 6499 (ER)
ERTXX	Collets DIN 6499 - Form Canela (ER) / Spannanzgen DIN 6499 - Form Canela (ER)
40.453..	Collet chucks for DIN 6499 (ER) collets / Spannanzgenfutter für DIN 6499 (ER) Spannanzgen
40.455..	Long collet chucks for DIN 6499 (ER) collets / Lange Spannanzgenfutter für DIN 6499 (ER) Spannanzgen



For more information see page / Für weitere Informationen siehe Seite: K.13, K.17, K.19, J.08, J.09

17  
TS ISO 26622-1

18  
PSC ISO 26623-1

20 23  
JIS B 6339-BT

25  
CHIRON

BORING HEADS  
BOHRKÖPFE

MORSE SHANKS  
MORSE SCHÄFTE

CYLINDRICAL SHANKS  
ZYLINDRISCHE SCHÄFTE

ACCESSORIES  
ZUBEHÖR

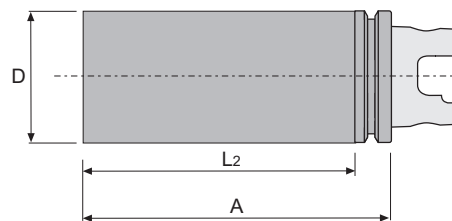



REF.	TS	D mm	L2 mm	A mm	
17.470.050.50/200	50	50	200	226	-
17.470.050.63/200		63	200	226	-
17.470.063.63/200	63	63	200	226	-
17.470.063.80/250		80	250	276	-
17.470.063.109/134		109	134	160	-
17.470.100.63/200	100	63	200	229	-
17.470.100.80/250		80	250	279	-
17.470.100.90/300		90	300	329	-

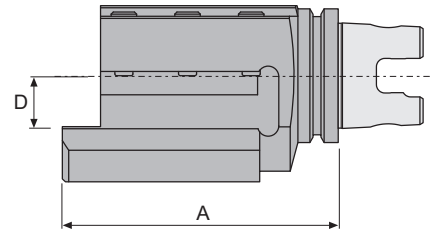





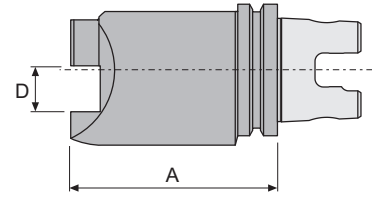

REF.	TS	D mm	A mm	
17.500.063.25 R/L	63	25	130	-
Turning toolholder for square tool left/right hand. Drehen Werkzeughalter für Vierkantmeißel links / rechts.				

REF.		
17.500.063.25 R/L	17012	29710

- 17 TS ISO 26622-1
- 18 PSC ISO 26623-1
- 20 23 JIS R 6339-RT
- 25 CHIRON
- BORING HEADS  
BOHRKÖPFE
- MORSE SHANKS  
MORSE SCHÄFTE
- CYLINDRICAL SHANKS  
ZYLINDRISCHE SCHÄFTE
- ACCESSORIES  
ZUBEHÖR



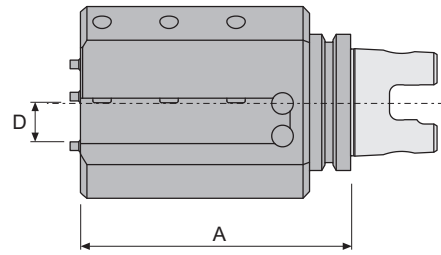

REF.	TS	D mm	A mm	 Kg
17.510.063.25 R/L	63	25	130	-
Turning toolholder for square tool left/right hand. Drehen Werkzeughalter für Vierkantmeißel links / rechts.				

REF.		
17.510.063.25 R/L	17012	29710



REF.	TS	D mm	A mm	
17.520.063.25 R/L	63	25	130	-
Multipurpose square toolholder. Multipurpose Platz Werkzeughalter.				

REF.		
17.520.063.25 R/L	17012	29710

17  
TS ISO 26622-1

18  
PSC ISO 26623-1

20 23  
JIS B 6339-RT

25  
CHIRON

BORING HEADS  
BOHRKÖPFE



MORSE SHANKS  
MORSE SCHÄFTE

CYLINDRICAL SHANKS  
ZYLINDRISCHE SCHÄFTE

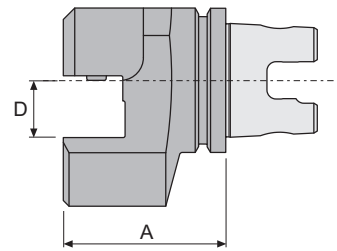
ACCESSORIES  
ZUBEHÖR



REF.	TS	D mm	A mm	
17.530.063.25	63	25	130	-
Multipurpose square toolholder. Multipurpose Platz Werkzeughalter.				

REF.		
17.530.063.25	17012	29710

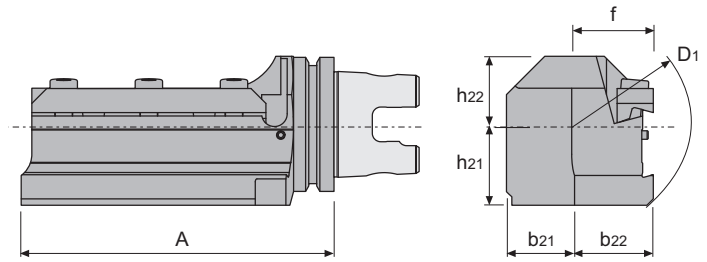

REF.	TS	D <sub>1</sub> mm	b <sub>21</sub> mm	b <sub>22</sub> mm	f mm	h <sub>21</sub> mm	h <sub>22</sub> mm	A mm	kg
17.540.063.32	63	106	32	37	32	38	32	147	3,300

REF.		
17.540.063.32	80632	11306

17  
TS ISO 26622-1

18  
PSC ISO 26623-1

20 23  
JIS B 6339-RT

25  
CHIRON

BORING HEADS  
BOHRKÖPFE



MORSE SHANKS  
MORSE SCHÄFTE

CYLINDRICAL SHANKS  
ZYLINDRISCHE SCHÄFTE

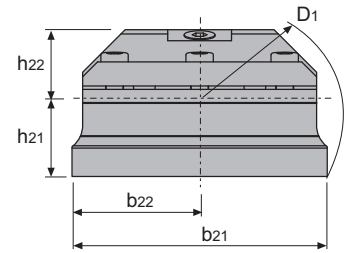
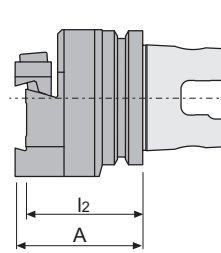



ACCESSORIES  
ZUBEHÖR

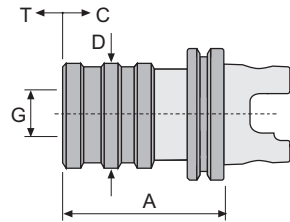

REF.	TS	D <sub>1</sub> mm	b <sub>21</sub> mm	b <sub>22</sub> mm	h <sub>21</sub> mm	h <sub>22</sub> mm	A mm	l <sub>22</sub> mm	
17.550.063.32	63	141	120	60	37	32	60	55	2,300

REF.		
17.550.063.32	80632	11306



REF.	TS	G Nº. Ø		A mm	D mm	C mm	T mm			
17.620.040.12	40	1 19	M3-M12	65	38	9	9	710XX	750XX	-
17.620.050.12	50	1 19	M3-M12	65	38	9	9	710XX	750XX	-
17.620.063.12	63	1 19	M3-M12	70	38	9	9	710XX	750XX	-
17.620.063.20		2 31	M8-M20	95	55	15	15	720XX	760XX	-
17.620.063.33		3 48	M14-M33	140	79	24	24	730XX	770XX	-

COMPENSATION IN COMPRESSION (C) AND TENSION (T)  
 AUSGLEICH DER KOMPRESSIION (C) UND DER TRAKTION (T)

REF.	ACCESSORIES / ZUBEHÖR
710XX..730XX	Quick change adpaters without overload clutch / Schnellwechseleinsätze ohne Sicherheitskupplung
750XX..770XX	Quick change adpaters with overload clutch / Schnellwechseleinsätze mit Sicherheitskupplung



710XX..730XX



750XX..770XX

For more information see page / Für weitere Informationen siehe Seite: K.06, K.07





10  
DIN 208011 13  
DIN 69871-A16  
HSK DIN 69893-117  
TS ISO 26622-1**CANELA**

CONTROL PINS

PRÜFDORNE

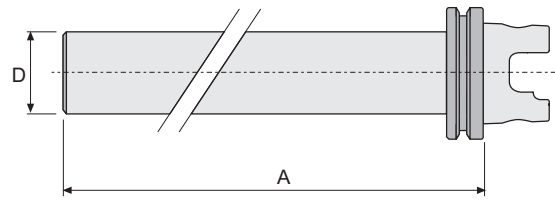
TS ISO 26622-1

**17.999**

REF.	TS	A	D	
17.999.040	40	300	40	-
17.999.050	50	300	40	-
17.999.063	63	300	40	-
17.999.080	80	300	50	-
17.999.100	100	300	50	-

**1** TYPE / TYP

17.160 	17.215 	17.296 	17.306 	17.315 
17.453 	17.470 	17.500 	17.510 	17.520 
17.530 	17.540 	17.550 	17.620 	

**2** DIMENSION / ABMESSUNG

<b>40</b>	<b>50</b>	<b>63</b>	<b>80</b>	<b>100</b>
-----------	-----------	-----------	-----------	------------

**3** LENGTH (A) / LÄNGE (A)

 <p style="text-align: center;">A</p>	<hr/> <hr/> <hr/> <hr/> <hr/>
--	-------------------------------

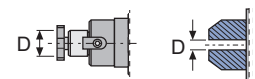
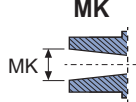
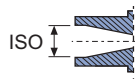
DIAMETER / DURCHMESSER	MK	ISO	COLLET SPANNZANGE
			

NOTES: \_\_\_\_\_

\_\_\_\_\_

\_\_\_\_\_

\_\_\_\_\_

\_\_\_\_\_

## MANUFACTURED FROM FORGED PARTS

## MATERIAL:

- Alloyed carburized steel at chrome-manganese 1.7131 (16MnCr5).

## EXECUTION:

- Carburized, hardness.  
- Surface hardness HRC 58±2 (670±40 HV30)  
- Depth minimum 0,5 mm.  
- Tensile strength in core minimum 800 N/mm<sup>2</sup> after carburizing.

## ACCURACY:

- Taper according to DIN 254  
- Taper angle:  
tolerance AT 3 DIN 7178 part 1 and DIN 2080 part 1.  
- Other tolerances according to DIN 7160 and 7168.  
- Taper surface roughness  $R_z < 0,001$  mm.

## HERGESTELLT AUS GESCHMIEDETEN TEILEN

## MATERIAL:

- Legierter Aufgekohlter Stahl mit Chrom-Mangan 1.7131 (16MnCr5).

## KONSTRUKTIONS DATEN:

- Aufgekohlt, gehärtet und angelassen.  
- Oberflächenhärte HRC 58±2 (670±40 HV30).  
- Aufgekohlt auf minimum 0,5 mm Tiefe.  
- Zugfestigkeit im Kern minimum 800 N/mm<sup>2</sup> nach der Aufkohlung.

## GENAUIGKEIT:

- Dorn nach DIN 254.  
- Kegelwinkel:  
Toleranz AT 3 DIN 7178 Teil 1 und DIN 2080 Teil 1.  
- Andere Toleranzen entsprechend DIN 7160 und 7168.  
- Rauigkeit der Oberfläche  $R_z < 0,001$  mm.

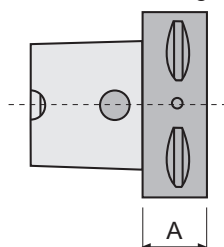

## TOLERANCE AT:

- Indicates the tolerance of size D surface between the real and the theoretical value of the taper conicity.  
- This value of surface D must always be less (negative), never more (positive) in order to GUARANTEE a good toolholder fixation at the bigger taper diameter.

## TOLERANZ AT:

- Zeigt die Toleranz auf der Messebene D zwischen dem tatsächlichen Wert der Kegelkonizität und dem theoretischen Wert.  
- Dieser Wert auf der Messebene D sollte immer minus (negativ) sein, nie plus (positiv), um für einen guten Halt des Futters in den größeren Durchmesser des Kegels zu garantieren.

## 18 ISO 26623-1

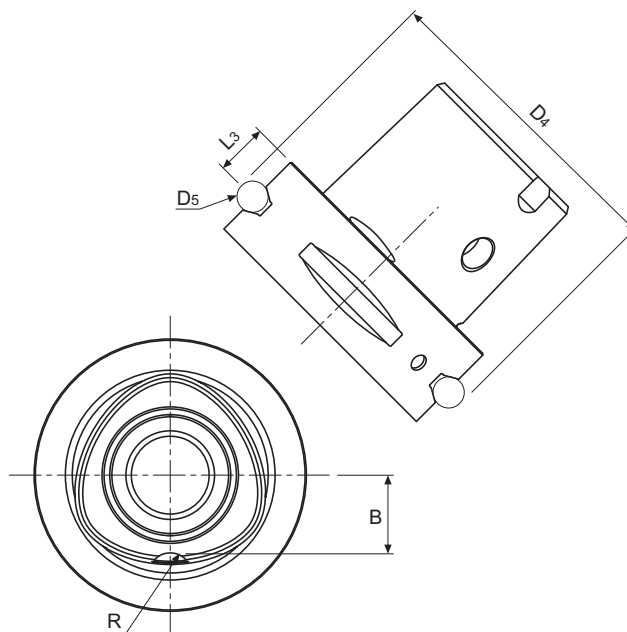
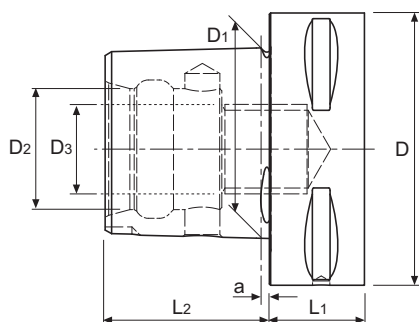

PSC	D mm	D <sub>1</sub> mm	D <sub>2</sub> mm	D <sub>3</sub> mm	D <sub>4</sub> mm	D <sub>5</sub> mm	L <sub>1</sub> min mm	L <sub>2</sub> mm	L <sub>3</sub> mm	a mm	B mm	R mm
32	32	22	15	M12 x 1,5	39,0	5	15	19	6	2,5	9,0	3
40	40	28	18	M14 x 1,5	46,0	5	20	24	8	2,5	11,0	3
50	50	35	21	M16 x 1,5	59,3	7	20	30	10	3,0	14,0	4
63	63	44	28	M20 x 2,0	70,7	7	22	38	12	3,0	18,0	5
80	80	55	32	M20 x 2,0	86,0	7	30	48	12	3,0	22,2	6
100	100	72	43	M24 x 2,0	110,0	10	32	60	16	3,0	29,2	6

<p>18.160</p>  <p>E.02</p>	<p>18.180</p>  <p>E.03</p>	<p>18.215</p>  <p>E.04</p>	<p>18.296</p>  <p>E.05</p>	<p>18.306</p>  <p>E.06</p>
<p>18.315</p>  <p>E.07</p>	<p>18.400</p>  <p>E.08</p>	<p>18.406</p>  <p>E.09</p>	<p>18.453</p>  <p>E.10</p>	<p>18.455</p>  <p>E.11</p>
<p>18.470</p>  <p>E.12</p>	<p>18.500</p>  <p>E.13</p>	<p>18.510</p>  <p>E.14</p>	<p>18.520</p>  <p>E.15</p>	<p>18.530</p>  <p>E.16</p>
<p>18.540</p>  <p>E.17</p>	<p>18.550</p>  <p>E.18</p>	<p>18.620</p>  <p>E.19</p>	<p>18.999</p>  <p>E.20</p>	

18  
PSC ISO 26623-1

20 23  
JIS B 6339-BT

25  
CHIRON





BORING HEADS  
BOHRKÖPFE

MORSE SHANKS  
MORSE SCHÄPFTE

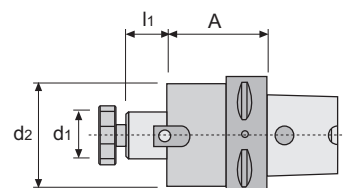



CYLINDRICAL SHANKS  
ZYLINDRISCHE SCHÄPFTE

ACCESSORIES  
ZUBEHÖR

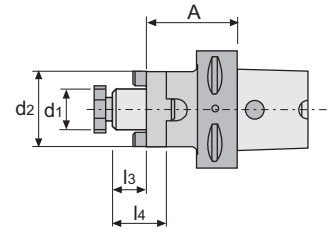

REF.	PSC	d <sub>1</sub> h6 mm	A mm	l <sub>1</sub> mm	d <sub>2</sub> mm				
18.160.040.16	40	16	55	17	37	10008	86016	11103	-
18.160.040.22		22	55	19	47	10010	86022	11004	-
18.160.050.16	50	16	60	17	37	10008	86016	11103	-
18.160.050.22		22	60	19	47	10010	86022	11004	-
18.160.050.27		27	60	21	58	10012	86027	11005	-
18.160.050.32		32	60	24	63	10016	86032	11105	-
18.160.063.16	63	16	63	17	37	10008	86016	11103	-
18.160.063.22		22	28	19	47	10010	86022	11004	-
18.160.063.22/100		22	100	19	47	10010	86022	11004	-
18.160.063.27		27	28	21	58	10012	86027	11005	-
18.160.063.27/100		27	100	21	58	10012	86027	11005	-
18.160.063.32		32	22	24	63	10016	86032	11105	-
18.160.063.32/100		32	100	24	63	10016	86032	11105	-
18.160.063.40		40	86	27	63	10020	86040	11006	-
18.160.063.40/100		40	100	27	63	10020	86040	11006	-
18.160.080.16	80	16	50	17	37	10008	86016	11103	-
18.160.080.22		22	30	19	47	10010	86022	11004	-
18.160.080.22/100		22	100	19	47	10010	86022	11004	-
18.160.080.27		27	30	21	58	10012	86027	11005	-
18.160.080.27/100		27	100	21	58	10012	86027	11005	-
18.160.080.32		32	30	24	63	10016	86032	11105	-
18.160.080.32/100		32	100	24	63	10016	86032	11105	-
18.160.080.40		40	30	27	63	10020	86040	11006	-
18.160.080.40/100		40	100	27	63	10020	86040	11006	-
18.160.080.60		60	60	40	130	10030	86060	11007	-
18.160.100.16	100	16	50	17	37	10008	86016	11103	-
18.160.100.22		22	50	19	47	10010	86022	11004	-
18.160.100.22/100		22	100	19	47	10010	86022	11004	-
18.160.100.27		27	50	21	58	10012	86027	11005	-
18.160.100.27/100		27	100	21	58	10012	86027	11005	-
18.160.100.32		32	50	24	63	10016	86032	11105	-
18.160.100.32/100		32	100	24	63	10016	86032	11105	-
18.160.100.40		40	50	27	63	10020	86040	11006	-
18.160.100.40/100		40	100	27	63	10020	86040	11006	-
18.160.100.60		60	70	40	130	10030	86060	11007	-



REF.	PSC	d <sub>1</sub> h6 mm	A mm	l <sub>3</sub> mm	l <sub>4</sub> mm	d <sub>2</sub> mm				
18.180.040.16	40	16	50	17	27	32	10008	60116	88016	-
18.180.040.22		22	50	19	31	40	10010	60122	88022	-
18.180.050.16	50	16	50	17	27	32	10008	60116	88016	-
18.180.050.22		22	50	19	31	40	10010	60122	88022	-
18.180.050.27		27	50	21	33	48	10012	60127	88027	-
18.180.050.32		32	60	24	38	58	10016	60132	88032	-
18.180.063.16	63	16	90	17	27	32	10008	60116	88016	-
18.180.063.22		22	90	19	31	40	10010	60122	88022	-
18.180.063.27		27	90	21	33	48	10012	60127	88027	-
18.180.063.32		32	90	24	38	58	10016	60132	88032	-
18.180.063.40		40	90	27	41	70	10020	60140	88040	-
18.180.080.16	80	16	100	17	27	32	10008	60116	88016	-
18.180.080.22		22	100	19	31	40	10010	60122	88022	-
18.180.080.27		27	100	21	33	48	10012	60127	88027	-
18.180.080.32		32	100	24	38	58	10016	60132	88032	-
18.180.080.40		40	100	27	41	70	10020	60140	88040	-
18.180.080.50		50	100	30	46	90	10024	60150	88050	-
18.180.100.16	100	16	100	17	27	32	10008	60116	88016	-
18.180.100.22		22	100	19	31	40	10010	60122	88022	-
18.180.100.27		27	100	21	33	48	10012	60127	88027	-
18.180.100.32		32	100	24	38	58	10016	60132	88032	-
18.180.100.40		40	100	27	41	70	10020	60140	88040	-
18.180.100.50		50	100	30	46	90	10024	60150	88050	-

18  
PSC ISO 26623-1

20 23  
JIS B 6339-BT

25  
CHIRON

BORING HEADS  
BOHRKÖPFE

MORSE SHANKS  
MORSE SCHÄFTE

CYLINDRICAL SHANKS  
ZYLINDRISCHE SCHÄFTE

ACCESSORIES  
ZUBEHÖR

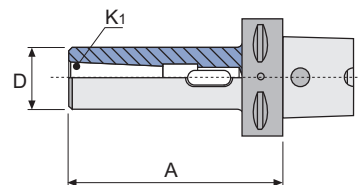

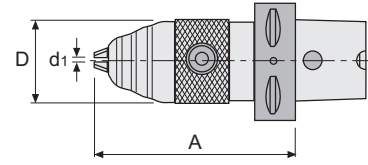

REF.	PSC	K <sub>1</sub> MORSE	A mm	D mm	kg
18.215.050.02	50	2	110	32	-
18.215.050.03		3	130	40	-
18.215.063.02	63	2	110	32	-
18.215.063.03		3	130	40	-
18.215.063.04		4	150	52	-
18.215.080.03	80	3	120	40	-
18.215.080.04		4	140	52	-
18.215.080.05		5	160	63	-
18.215.100.03	100	3	130	40	-
18.215.100.04		4	150	52	-
18.215.100.05		5	160	63	-





REF.	PSC	d <sub>1</sub> mm	D mm	A mm	kg
18.296.040.13	40	0.5 - 13	50	112	-
18.296.050.13	50	0.5 - 13	50	112	-
18.296.063.13	63	0.5 - 13	50	112	-
18.296.063.16		3.0 - 16	57	112	-
18.296.080.13	80	0.5 - 13	50	125	-
18.296.080.16		3.0 - 16	57	125	-
18.296.100.13	100	0.5 - 13	50	135	-
18.296.100.16		3.0 - 16	57	135	-

\* SUPPLIED WITH WRENCH / \* GELIEFERT MIT SCHLÜSSEL

REF.		3 x 
18.296.040.13	50706	60313
18.296.050.13	50706	60313
18.296.063.13	50706	60313
18.296.063.16	50706	60313
18.296.080.13	50706	60313
18.296.080.16	50706	60313
18.296.100.13	50706	60313
18.296.100.16	50706	60313

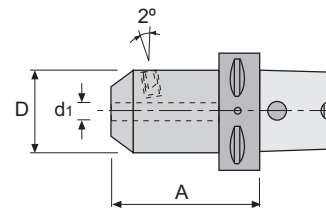



REF.	PSC	d <sub>1</sub> mm	D mm	A mm	2 x 		
18.306.040.06	40	06	25	50	15006	-	
18.306.040.08		08	28	50	15008	-	
18.306.040.10		10	35	50	15010	-	
18.306.040.12		12	42	55	15012	-	
18.306.040.16		16	48	55	15114	-	
18.306.050.06	50	06	25	55	15006	-	
18.306.050.08		08	28	55	15008	-	
18.306.050.10		10	35	65	15010	-	
18.306.050.12		12	42	65	15012	-	
18.306.050.14		14	42	65	15012	-	
18.306.050.16		16	48	65	15114	-	
18.306.050.18		18	48	65	15114	-	
18.306.050.20		20	52	65	15116	-	
18.306.050.25		25	65	80	4 x 15018	-	
18.306.063.06		63	06	25	80	15006	-
18.306.063.08	08		28	80	15008	-	
18.306.063.10	10		35	80	15010	-	
18.306.063.12	12		42	80	15012	-	
18.306.063.14	14		42	80	15012	-	
18.306.063.16	16		48	80	15114	-	
18.306.063.18	18		48	80	15114	-	
18.306.063.20	20		52	80	15116	-	
18.306.063.25	25		65	90	4 x 15018	-	
18.306.063.32	32		72	90	4 x 15120	-	
18.306.063.40	40		80	95	4 x 15120	-	
18.306.080.12	80		12	42	80	15012	-
18.306.080.16			16	48	80	15114	-
18.306.080.20		20	52	80	15116	-	
18.306.080.25		25	65	90	4 x 15018	-	
18.306.080.32		32	72	90	4 x 15120	-	
18.306.080.40		40	80	110	4 x 15120	-	
18.306.080.50		50	100	120	4 x 15124	-	
18.306.100.12		100	12	42	100	15012	-
18.306.100.16	16		48	100	15114	-	
18.306.100.20	20		52	100	15116	-	
18.306.100.25	25		65	100	4 x 15018	-	
18.306.100.32	32		72	100	4 x 15120	-	
18.306.100.40	40		80	120	4 x 15120	-	
18.306.100.50	50		100	130	4 x 15124	-	

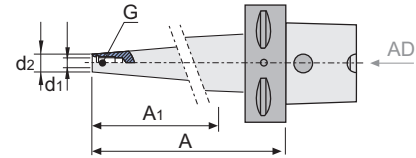

REF.	PSC	A mm	d <sub>1</sub> mm	d <sub>2</sub> mm	A <sub>1</sub> mm	⚖️ kg
18.315.040.08	40	70	M8	12,8	45	-
18.315.040.10		80	M10	17,8	55	-
18.315.040.12		80	M12	20,8	55	-
18.315.050.08	50	70	M8	12,8	45	-
18.315.050.10		80	M10	17,8	55	-
18.315.050.12		80	M12	20,8	55	-
18.315.050.16		80	M16	28,8	55	-
18.315.063.08	63	70	M8	12,8	40	-
18.315.063.10		90	M10	17,8	60	-
18.315.063.12		100	M12	20,8	60	-
18.315.063.16		100	M16	28,8	60	-
18.315.080.12	80	100	M12	20,8	60	-
18.315.080.16		100	M16	28,8	60	-
18.315.100.12	100	120	M12	20,8	80	-
18.315.100.16		120	M16	28,8	80	-

REF.	ACCESSORIES / ZUBEHÖR
06.315	Front contact extensions for modular tools. / Stirnverlängerung für Einschraubfräser.
06.315	Front contact reducers for modular tools. / Stirnreduzierhülsen für Einschraubfräser.



06.315



06.315

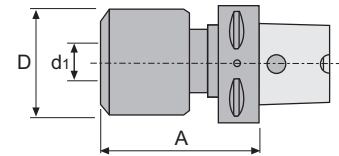

For more information see page / Für weitere Informationen siehe Seite: J.02, J.03



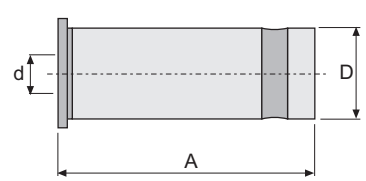

REF.	PSC	A mm	d <sub>1</sub> mm	D mm	kg
18.400.063.20	63	100	20	54	-
18.400.080.32	80	110	32	72	-
18.400.100.32	100	120	32	72	-

**COMPLEMENTS (Collets type C) / ZUBEHÖR (Spannzangen typ C)**

REF.	d mm	D mm	A mm
C2006	6	20	55
C2008	8	20	55
C2010	10	20	55
C2012	12	20	55
C2016	16	20	55
C3206	6	32	65
C3208	8	32	65
C3210	10	32	65
C3212	12	32	65
C3216	16	32	65
C3220	20	32	65
C3225	25	32	65

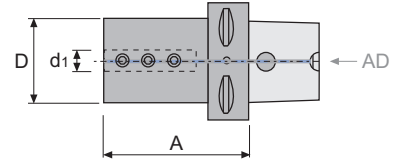

REF.	PSC	A mm	d <sub>1</sub> mm	D mm	3 x 	
18.406.040.08	40	75	08	44	15108	-
18.406.040.10		75	10	44	15110	-
18.406.040.12		75	12	44	15212	-
18.406.040.16		75	16	44	15314	-
18.406.050.08	50	75	08	44	15108	-
18.406.050.10		75	10	44	15110	-
18.406.050.12		75	12	44	15212	-
18.406.050.16		75	16	44	15314	-
18.406.050.20		75	20	50	15216	-
18.406.050.25		75	25	55	15218	-
18.406.063.08	63	75	08	44	15108	-
18.406.063.10		75	10	44	15110	-
18.406.063.12		75	12	44	15212	-
18.406.063.16		75	16	44	15314	-
18.406.063.20		75	20	50	15216	-
18.406.063.25		75	25	55	15218	-
18.406.063.32		75	32	72	15220	-
18.406.063.40		85	40	98	15220	-
18.406.080.16	80	85	16	44	15314	-
18.406.080.20		85	20	50	15216	-
18.406.080.25		85	25	55	15218	-
18.406.080.32		85	32	72	15220	-
18.406.080.40		95	40	98	15220	-
18.406.080.50		100	50	98	15024	-
18.406.100.16	100	100	16	44	15314	-
18.406.100.20		100	20	50	15216	-
18.406.100.25		100	25	55	15218	-
18.406.100.32		100	32	72	15220	-
18.406.100.40		110	40	98	15220	-
18.406.100.50		120	50	98	15024	-

18  
PSC ISO 26623-1

20 23  
JIS B 6339-BT

25  
CHIRON

BORING HEADS  
BOHRKÖPFE

MORSE SHANKS  
MORSE SCHÄFTE

CYLINDRICAL SHANKS  
ZYLINDRISCHE SCHÄFTE

ACCESSORIES  
ZUBEHÖR

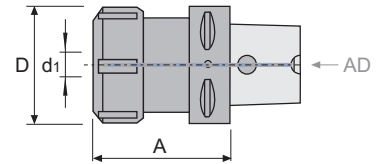

\* If you want with ball bearing nut, see page: K.22

\* Wenn Sie diese mit Kugellager-Nute möchten, siehe Seite: K.22

\* SUPPLIED WITHOUT WRENCH / \* GELIEFERT OHNE SCHLÜSSEL

REF.	PSC		A mm	d <sub>1</sub> mm	D mm				kg
18.453.040.16	40	ER16	60	0,5-10	28	45316	50216	19210	-
18.453.040.20		ER20	60	1-13	34	45320	50220	19212	-
18.453.040.25		ER25	60	1-16	42	45325	50225	19216	-
18.453.040.32		ER32	60	2-20	50	45332	50232	19218	-
18.453.050.16	50	ER16	60	0,5-10	28	45316	50216	19210	-
18.453.050.16/100		ER16	100	0,5-10	28	45316	50216	19210	-
18.453.050.20		ER20	60	1-13	34	45320	50220	19212	-
18.453.050.20/100		ER20	100	1-13	34	45320	50220	19212	-
18.453.050.25		ER25	60	1-16	42	45325	50225	19216	-
18.453.050.25/100		ER25	100	1-16	42	45325	50225	19216	-
18.453.050.32		ER32	60	2-20	50	45332	50232	19218	-
18.453.050.32/100		ER32	100	2-20	50	45332	50232	19218	-
18.453.050.40		ER40	65	3-30	63	45340	50240	19224	-
18.453.050.40/100		ER40	100	3-30	63	45340	50240	19224	-
18.453.063.16	63	ER16	60	0,5-10	28	45316	50216	19210	-
18.453.063.16/100		ER16	100	0,5-10	28	45316	50216	19210	-
18.453.063.20		ER20	60	1-13	34	45320	50220	19212	-
18.453.063.20/100		ER20	100	1-13	34	45320	50220	19212	-
18.453.063.25		ER25	60	1-16	42	45325	50225	19216	-
18.453.063.25/100		ER25	100	1-16	42	45325	50225	19216	-
18.453.063.32		ER32	60	2-20	50	45332	50232	19218	-
18.453.063.32/100		ER32	100	2-20	50	45332	50232	19218	-
18.453.063.40		ER40	70	3-30	63	45340	50240	19224	-
18.453.063.40/120		ER40	120	3-30	63	45340	50240	19224	-
18.453.080.32	80	ER32	70	2-20	50	45332	50232	19218	-
18.453.080.32/160		ER32	160	2-20	50	45332	50232	19218	-
18.453.080.40		ER40	70	3-30	63	45340	50240	19224	-
18.453.080.40/160		ER40	160	3-30	63	45340	50240	19224	-
18.453.100.32	100	ER32	100	2-20	50	45332	50232	19218	-
18.453.100.32/160		ER32	160	2-20	50	45332	50232	19218	-
18.453.100.40		ER40	100	3-30	63	45340	50240	19224	-
18.453.100.40/160		ER40	160	3-30	63	45340	50240	19224	-
18.453.100.50		ER50	100	6-34	78	45350	50250	19230	-
18.453.100.50/160		ER50	160	6-34	78	45350	50250	19230	-

REF.	ACCESSORIES / ZUBEHÖR
ERXX	Collets double slot DIN 6499 - Form B (ER) / Spannanzgen mit Doppelnut DIN 6499 - Form B (ER)
ERCXX	Sealed collets DIN 6499 (ER) / Abgedichtete Spannanzgen DIN 6499 (ER)
ERTXX	Collets DIN 6499 - Form Canela (ER) / Spannanzgen DIN 6499 - Form Canela (ER)
40.453..	Collet chucks for DIN 6499 (ER) collets / Spannanzgenfutter für DIN 6499 (ER) Spannanzgen
40.455..	Long collet chucks for DIN 6499 (ER) collets / Lange Spannanzgenfutter für DIN 6499 (ER) Spannanzgen



ERXX



ERCXX



ERTXX



40.453..





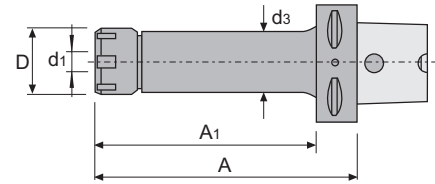

40.455..

For more information see page / Für weitere Informationen siehe Seite: K.13, K.17, K.19, J.08, J.09

WITH "MINI" COLLET NUT  
MIT "MINI"-SPANNMUTTER



REF.	PSC		d <sub>1</sub> mm	A mm	D mm	A <sub>1</sub> mm	d <sub>3</sub> mm				
18.455.063.16	63	ER16	0,5-10	60	22	-	-	45516	50916	19210	-
18.455.063.16/100		ER16	0,5-10	100	22	100	30	45516	50916	19210	-
18.455.063.20		ER20	1-13	60	28	-	-	45520	50920	19212	-
18.455.063.20/100		ER20	1-13	100	28	100	30	45520	50920	19212	-

\* SUPPLIED WITHOUT WRENCH / \* GELIEFERT OHNE SCHLÜSSEL

REF.	ACCESSORIES / ZUBEHÖR
ERXX	Collets double slot DIN 6499 - Form B (ER) / Spannzangen mit Doppelnut DIN 6499 - Form B (ER)
ERCXX	Sealed collets DIN 6499 (ER) / Abgedichtete Spannzangen DIN 6499 (ER)
ERTXX	Collets DIN 6499 - Form Canela (ER) / Spannzangen DIN 6499 - Form Canela (ER)



ERXX



ERCXX





ERTXX

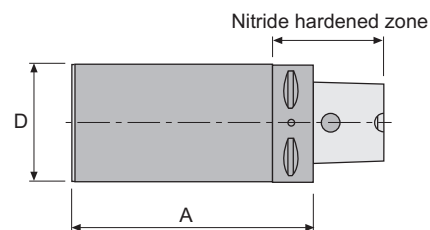

For more information see page / Für weitere Informationen siehe Seite: K.13, K.17, K.19

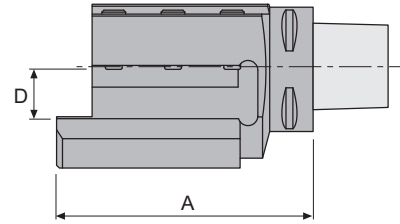

REF.	PSC	D mm	A mm	kg
18.470.032.032/090	32	32	90	-
18.470.032.040/110		40	110	-
18.470.032.050/125		50	125	-
18.470.032.060/090		60	90	-
18.470.032.070/060		70	60	-
18.470.032.090/070		90	70	-
18.470.040.040/095	40	40	95	-
18.470.040.040/120		40	120	-
18.470.040.060/165		60	165	-
18.470.040.080/075		80	75	-
18.470.040.080/120		80	120	-
18.470.040.100/085		100	85	-
18.470.050.050/125	50	50	125	-
18.470.050.050/150		50	150	-
18.470.050.063/180		63	180	-
18.470.050.075/175		75	175	-
18.470.050.090/080		90	80	-
18.470.050.095/150		95	150	-
18.470.050.110/090		110	90	-
18.470.063.063/180	63	63	180	-
18.470.063.075/195		75	195	-
18.470.063.110/120		110	120	-
18.470.063.110/085		110	85	-
18.470.063.120/180		120	180	-
18.470.063.130/095		130	95	-
18.470.080.080/200	80	80	200	-
18.470.080.100/200		100	200	-
18.470.080.120/160		120	160	-
18.470.080.130/090		130	90	-
18.470.080.145/200		145	200	-
18.470.080.150/200		150	200	-
18.470.080.160/120		160	120	-
18.470.100.100/100	100	100	100	-
18.470.100.100/200		100	200	-
18.470.100.150/100		150	100	-
18.470.100.150/200		150	200	-
18.470.100.160/150		160	150	-
18.470.100.200/100		200	100	-



REF.	PSC	Type / Typ	D mm	A mm	
18.500.050.20 R/L	50	Turning toolholder for square tool left/right hand.	20	98	
18.500.063.25 R/L	63			130	
18.500.063.32 R/L		Drehen Werkzeughalter für Vierkantmeißel links / rechts.	32	115	
18.500.080.32 R/L	80		32	140	
18.500.100.32 R/L	100		32	160	

REF.		
18.500.050.20 R/L	17012	29708
18.500.063.25 R/L	17012	29710
18.500.063.32 R/L	17012	29710
18.500.080.32 R/L	17012	29710
18.500.100.32 R/L	17012	29710

18  
PSC ISO 26623-1

20 23  
JIS R 6339-BT

25  
CHIRON

BORING HEADS  
BOHRKÖPFE

MORSE SHANKS  
MORSE SCHÄFTE

CYLINDRICAL SHANKS  
ZYLINDRISCHE SCHÄFTE

ACCESSORIES  
ZUBEHÖR



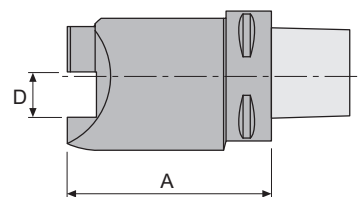

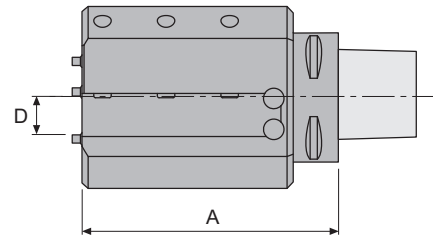

REF.	PSC	Type / Typ	D mm	A mm	
18.510.050.20 R/L	50	Turning toolholder for square tool left/right hand.	20	100	
18.510.063.25 R/L	63		25	130	
18.510.080.32 R/L	80	Drehen Werkzeughalter für Vierkantmeißel links / rechts.	32	135	
18.510.100.32 R/L	100		32	145	

REF.		
18.510.050.20 R/L	17012	29708
18.510.063.25 R/L	17012	29710
18.510.080.32 R/L	17012	29710
18.510.100.32 R/L	17012	29710



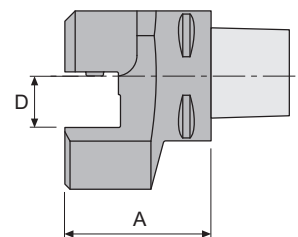

REF.	PSC	Type / Typ	D mm	A mm	
18.520.050.20 R/L	50	Multipurpose square toolholder.	20	100	
18.520.063.25 R/L	63		25	130	
18.520.080.32 R/L	80	Multipurpose Platz Werkzeughalter.	32	150	
18.520.100.32 R/L	100		32	160	

REF.		
18.520.050.20 R/L	17012	29708
18.520.063.25 R/L	17012	29710
18.520.080.32 R/L	17012	29710
18.520.100.32 R/L	17012	29710



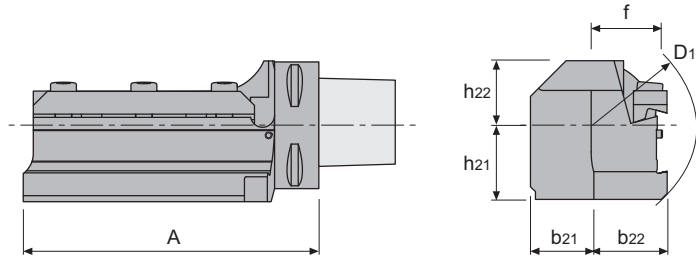

REF.	PSC	Type / Typ	D mm	A mm	
18.530.050.20	50	Multipurpose square toolholder.	20	100	
18.530.063.25	63		25	130	
18.530.080.32	80	Multipurpose Platz Werkzeughalter.	32	130	
18.530.100.32	100		22	140	

REF.		
18.530.050.20	17012	29708
18.530.063.25	17012	29710
18.530.080.32	17012	29710
18.530.100.32	17012	29710





REF.	PSC	D <sub>1</sub> mm	b <sub>21</sub> mm	b <sub>22</sub> mm	f mm	h <sub>21</sub> mm	h <sub>22</sub> mm	A mm	⚖ kg
18.540.050.26	50	87	25.5	31.0	26.0	30.0	26.0	95	1,500
18.540.063.32	63	106	32.0	37.0	32.0	38.0	32.0	147	3,300
18.540.080.32	80	122	40.0	45.5	40.5	40.5	40.5	155	5,200
18.540.100.32	100	160	50.0	55.5	50.5	60.5	50.0	175	
18.540.100.52		180	50.0	55.5	50.5	65.5	50.0	300	

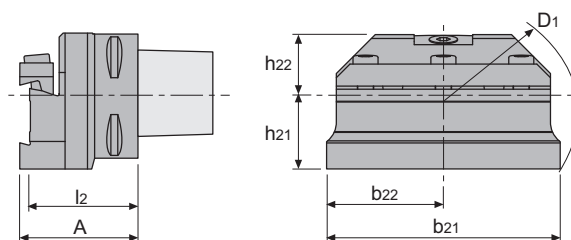



REF.		
18.540.050.26	80526	11306
18.540.063.32	80632	11306
18.540.080.32	80832	11306
18.540.100.32	81032	11306
18.540.100.52	81052	11308

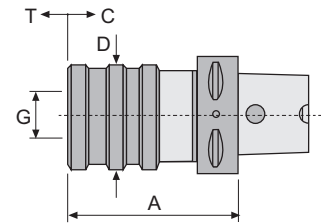

REF.	PSC	D <sub>1</sub> mm	b <sub>21</sub> mm	b <sub>22</sub> mm	h <sub>21</sub> mm	h <sub>22</sub> mm	A mm	l <sub>2</sub> mm	
18.550.050.26	50	100	80	40.0	30.0	25.2	58	53	1,300
18.550.063.32	63	141	120	60.0	37.0	32.0	60	55	2,300
18.550.080.32	80	145	120	60.0	40.5	40.0	68	63	3,500
18.550.100.32	100	145	120	60.0	40.5	40.0	83	78	-
18.550.100.52		165	135	67.5	65.5	50.0	83	78	-

REF.		
18.550.050.26	80526	11306
18.550.063.32	80632	11306
18.550.080.32	80832	11306
18.550.100.32	81032	11306
18.550.100.52	81052	11308



REF.	PSC	G Nº. Ø		A mm	D mm	C mm	T mm			
18.620.040.12	40	1 19	M3-M12	65	38	9	9	710XX	750XX	-
18.620.050.12	50	1 19	M3-M12	65	38	9	9	710XX	750XX	-
18.620.063.12	63	1 19	M3-M12	70	38	9	9	710XX	750XX	-
18.620.063.20		2 31	M8-M20	95	55	15	15	720XX	760XX	-
18.620.063.33		3 48	M14-M33	140	79	24	24	730XX	770XX	-
18.620.080.12	80	1 19	M3-M12	80	38	9	9	710XX	750XX	-
18.620.080.20		2 31	M8-M20	100	55	15	15	720XX	760XX	-
18.620.080.33		3 48	M14-M33	150	79	24	24	730XX	770XX	-
18.620.100.12	100	1 19	M3-M12	90	38	9	9	710XX	750XX	-
18.620.100.20		2 31	M8-M20	110	55	15	15	720XX	760XX	-
18.620.100.33		3 48	M14-M33	160	79	24	24	730XX	770XX	-

COMPENSATION IN COMPRESSION (C) AND TENSION (T)  
 AUSGLEICH DER KOMPRESSION (C) UND DER TRAKTION (T)

REF.	ACCESSORIES / ZUBEHÖR
710XX..730XX	Quick change adapters without overload clutch / Schnellwechseleinsätze ohne Sicherheitskupplung
750XX..770XX	Quick change adapters with overload clutch / Schnellwechseleinsätze mit Sicherheitskupplung



710XX..730XX



750XX..770XX

For more information see page / Für weitere Informationen siehe Seite: K.06, K.07

10  
DIN 208011 13  
DIN 69871-A16  
HSK DIN 69893-117  
TS ISO 26622-118  
PSC ISO 26623-1

PSC ISO 26623-1

**CANELA**

CONTROL PINS

PRÜFDORNE

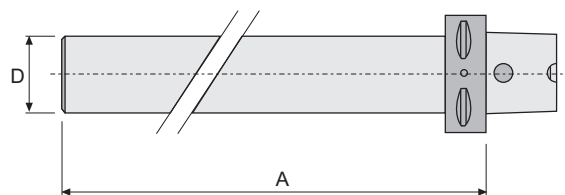
**18.999**

REF.	PSC	A	D	 Kg
18.999.050	50	300	40	-
18.999.063	63	300	40	-
18.999.080	80	300	50	-
18.999.100	100	300	50	-

**1 TYPE / TYP**

18.160 	18.180 	18.215 	18.296 	18.306 
18.315 	18.400 	18.406 	18.453 	18.455 
18.470 	18.500 	18.510 	18.520 	18.530 
18.540 	18.550 	18.620 		

**2 DIMENSION / ABMESSUNG**

<b>32</b>	<b>40</b>	<b>50</b>	<b>63</b>	<b>80</b>	<b>100</b>
-----------	-----------	-----------	-----------	-----------	------------

**3 LENGTH (A) / LÄNGE (A)**

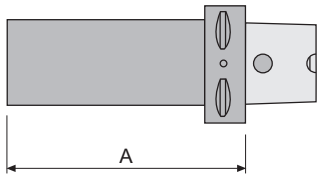

A

---

---

---

---

---

---

---

---

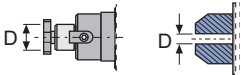
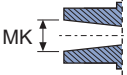
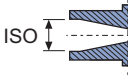
DIAMETER / DURCHMESSER	MK	ISO	COLLET SPANNZANGE
			

NOTES: \_\_\_\_\_

\_\_\_\_\_

\_\_\_\_\_

\_\_\_\_\_

\_\_\_\_\_



## MANUFACTURED FROM FORGED PARTS

## MATERIAL:

- Alloyed carburized steel at chrome-manganese 1.7131 (16MnCr5).

## EXECUTION:

- Carburized, hardness.  
- Surface hardness HRC 58±2 (670±40 HV30)  
- Depth minimum 0,5 mm.  
- Tensile strength in core minimum 800 N/mm<sup>2</sup> after carburizing.

## ACCURACY:

- Taper according to DIN 254  
- Taper angle:  
tolerance AT 3 DIN 7178 part 1 and DIN 2080 part 1.  
- Other tolerances according to DIN 7160 and 7168.  
- Taper surface roughness R<sub>z</sub><0,001 mm.

K	AT 3 mm
ISO 30	0,002
ISO 40	0,003
ISO 45	0,003
ISO 50	0,004
ISO 60	0,005

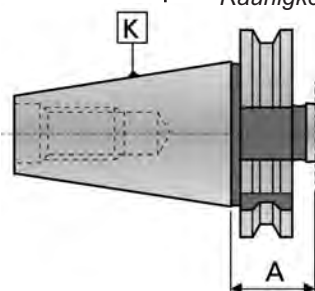

## HERGESTELLT AUS GESCHMIEDETEN TEILEN

## MATERIAL:

- Legierter Aufgekohlter Stahl mit Chrom-Mangan 1.7131 (16MnCr5).

## KONSTRUKTIONSDATEN:

- Aufgekohlt, gehärtet und angelassen.  
- Oberflächenhärte HRC 58±2 (670±40 HV30).  
- Aufgekohlt auf minimum 0,5 mm Tiefe.  
- Zugfestigkeit im Kern minimum 800 N/mm<sup>2</sup> nach der Aufkohlung.

## GENAUIGKEIT:

- Dorn nach DIN 254.  
- Kegelwinkel:  
Toleranz AT 3 DIN 7178 Teil 1 und DIN 2080 Teil 1.  
- Andere Toleranzen entsprechend DIN 7160 und 7168.  
- Rauigkeit der Oberfläche R<sub>z</sub><0,001 mm.

PREBALANCED  
TOOLHOLDERSVORGEWUCHTETE  
WERKZEUGHALTER

ISO 40 ▶ 8000 rpm ISO 50 ▶ 8000 rpm

## TOLERANCE AT:

- Indicates the tolerance of size D surface between the real and the theoretical value of the taper conicity.  
- This value of surface D must always be less (negative), never more (positive) in order to GUARANTEE a good toolholder fixation at the bigger taper diameter.

## TOLERANZ AT:

- Zeigt die Toleranz auf der Messebene D zwischen dem tatsächlichen Wert der Kegelkonizität und dem theoretischen Wert.  
- Dieser Wert auf der Messebene D sollte immer minus (negativ) sein, nie plus (positiv), um für einen guten Halt des Futter in den größeren Durchmesser des Kegels zu garantieren.

20

JIS B 6339 - BT

FORM A : SIMILAR DIN 69871 AD  
ÄHNLICH WIE DIN 69871 AD

WITHOUT THROUGH HOLE  
OHNE DURCHGANGSLOCH

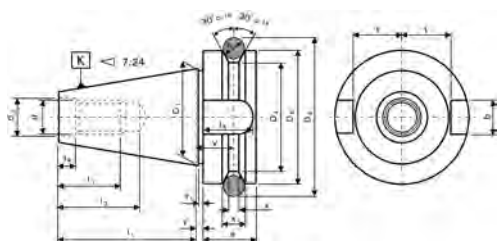

23

JIS B 6339 - BT

FORM B : SIMILAR DIN 69871 AD+B  
ÄHNLICH WIE DIN 69871 AD+B

WITH CENTRAL COOLANT FEED THROUGH THE COLLAR  
MIT ZENTRALEM KÜHLMITTELZUFUHR DURCH DEM BUND

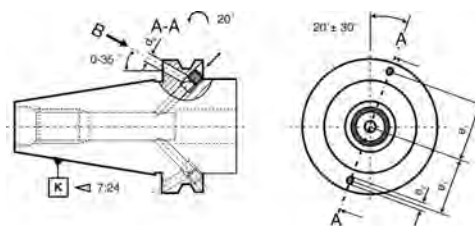

K ISO	D <sub>1</sub> mm	l <sub>1±0,2</sub> mm	d <sub>2</sub> H8 mm	g 6H mm	l <sub>2</sub> min mm	l <sub>3</sub> min mm	l <sub>4+0,5/0</sub> mm	b H12 mm	l <sub>5</sub> min mm	t <sub>0/-0,2</sub> mm
30	31,75	48,4	12,5	M 12	24	34	7	16,1	17	16,3
35	38,10	56,4	12,5	M 12	24	34	7	16,1	20	19,6
40	44,45	65,4	17,0	M 16	30	43	9	16,1	21	22,6
45	57,15	82,8	21,0	M 20	38	53	11	19,3	26	29,1
50	69,85	101,8	25,0	M 24	45	62	13	25,7	31	35,1

K ISO	D <sub>4</sub> mm	D <sub>5</sub> h8 mm	e mm	v <sub>±0,1</sub> mm	x mm	x <sub>1±0,1/0</sub> mm	y <sub>±0,4</sub> mm	y <sub>1±0,5/0</sub> mm	d <sub>9</sub> mm	e <sub>1±0,1</sub> mm	e <sub>2</sub> max mm
30	38	46	20	13,6	4	8	2	7	4	21	5
35	43	53	22	14,6	5	10	2	7	-	-	-
40	53	63	25	16,6	5	10	2	9	4	27	5
45	73	85	30	21,2	6	12	3	11	5	35	6
50	85	100	35	23,2	7	15	3	13	6	42	7

<p>20.160</p>  <p>F.03</p>	<p>20.165</p>  <p>F.07</p>	<p>20.180</p>  <p>F.08</p>	<p>20.210</p>  <p>F.09</p>	<p>20.215</p>  <p>F.11</p>
<p>20.216</p>  <p>F.13</p>	<p>20.225/6</p>  <p>F.14</p>	<p>20.290</p>  <p>F.15</p>	<p>20.295</p>  <p>F.16</p>	<p>20.296</p>  <p>F.17</p>
<p>20.300</p>  <p>F.20</p>	<p>20.302</p>  <p>F.22</p>	<p>20.305</p>  <p>F.24</p>	<p>20.353</p>  <p>F.29</p>	<p>20.400</p>  <p>F.30</p>
<p>20.453</p>  <p>F.32</p>	<p>20.455</p>  <p>F.33</p>	<p>20.457</p>  <p>F.34</p>	<p>20.470</p>  <p>F.36</p>	<p>20.512</p>  <p>F.37</p>
<p>20.610</p>  <p>F.38</p>	<p>20.620</p>  <p>F.40</p>	<p>20.630</p>  <p>F.41</p>	<p>20.999</p>  <p>F.42</p>	<p><b>A20.160</b> Antivibratory Schwingungsgedämpft</p>  <p>F.05</p>
<p><b>A20.160</b> Antivibratory Schwingungsgedämpft</p>  <p>F.06</p>	<p><b>A20.315</b> Antivibratory Schwingungsgedämpft</p>  <p>F.28</p>	<p>23.160</p>  <p>F.04</p>	<p>23.210</p>  <p>F.10</p>	<p>23.215</p>  <p>F.12</p>
<p>23.296</p>  <p>F.18</p>	<p>23.297</p>  <p>F.19</p>	<p>23.300</p>  <p>F.21</p>	<p>23.302</p>  <p>F.23</p>	<p>23.306</p>  <p>F.25</p>

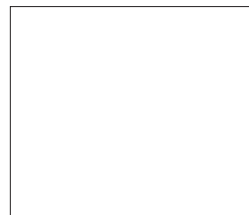
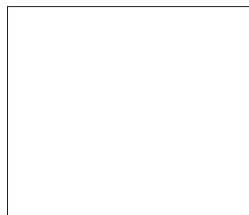
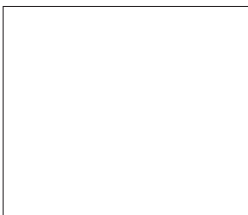
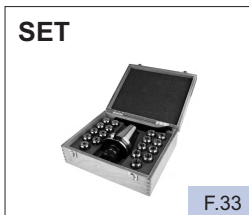

# CANELA

# JIS B 6339-BT 20/23

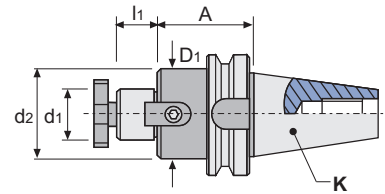





REF.	K ISO	d <sub>1</sub> h6 mm	A mm	l <sub>1</sub> mm	d <sub>2</sub> mm	D <sub>1</sub> mm	⚖ Kg
20.160.30.16	30	16	40	17	38	-	0,620
20.160.30.22		22	40	19	48	-	0,700
20.160.30.27		27	45	21	58	-	0,870
20.160.40.16	40	16	40	17	38	-	1,190
20.160.40.16/100		16	100	17	38	38	1,580
20.160.40.22		22	45	19	48	-	1,290
20.160.40.22/100		22	100	19	48	48	2,180
20.160.40.27		27	50	21	58	-	1,650
20.160.40.27/100		27	100	21	58	58	2,420
20.160.40.32		32	50	24	78	-	1,730
20.160.40.32/125		32	125	24	78	63	3,100
20.160.40.40		40	55	27	88	-	2,130
20.160.50.16		50	16	55	17	38	-
20.160.50.16/150	16		100	17	38	38	4,880
20.160.50.22	22		55	19	48	-	4,150
20.160.50.22/150	22		150	19	48	48	5,500
20.160.50.27	27		60	21	58	-	4,280
20.160.50.27/150	27		150	21	58	58	6,300
20.160.50.32	32		60	24	78	-	4,320
20.160.50.32/150	32		150	24	78	63	8,300
20.160.50.40	40		65	27	88	-	5,370
20.160.50.40/150	40		150	27	88	73	9,530
20.160.50.50	50		65	30	90	-	5,700

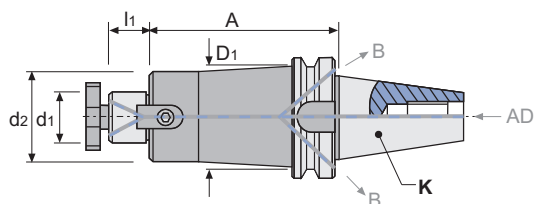



REF.			
20.160.30.16	10008	86016	11103
20.160.30.22	10010	86022	11004
20.160.30.27	10012	86027	11005
20.160.40.16	10008	86016	11103
20.160.40.16/100	10008	86016	11103
20.160.40.22	10010	86022	11004
20.160.40.22/100	10010	86022	11004
20.160.40.27	10012	86027	11005
20.160.40.27/100	10012	86027	11005
20.160.40.32	10016	86032	11105
20.160.40.32/125	10016	86032	11105
20.160.40.40	10020	86040	11006
20.160.50.16	10008	86016	11103
20.160.50.16/150	10008	86016	11103
20.160.50.22	10010	86022	11004
20.160.50.22/150	10010	86022	11004
20.160.50.27	10012	86027	11005
20.160.50.27/150	10012	86027	11005
20.160.50.32	10016	86032	11105
20.160.50.32/150	10016	86032	11105
20.160.50.40	10020	86040	11006
20.160.50.40/150	10020	86040	11006
20.160.50.50	10024	86050	11008

SIMILAR / ÄHNLICH WIE  
 DIN 69871 - Form AD+B

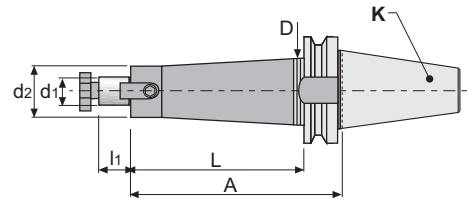
REF.	K ISO	d <sub>1</sub> h6 mm	A mm	l <sub>1</sub> mm	d <sub>2</sub> mm	D <sub>1</sub> mm	⚖ kg
23.160.40.16	40	16	40	17	38	-	1,150
23.160.40.16/100		16	100	17	38	38	1,450
23.160.40.22		22	45	19	48	-	1,310
23.160.40.22/100		22	100	19	48	48	2,080
23.160.40.27		27	50	21	58	-	1,570
23.160.40.27/100		27	100	21	58	58	2,590
23.160.40.32		32	50	24	78	-	1,700
23.160.40.32/125		32	125	24	78	63	3,140
23.160.40.40		40	55	27	88	-	2,070
23.160.50.16		50	16	55	17	38	-
23.160.50.16/150	16		100	17	38	38	4,590
23.160.50.22	22		55	19	48	-	3,970
23.160.50.22/150	22		150	19	48	48	5,230
23.160.50.27	27		60	21	58	-	4,230
23.160.50.27/150	27		150	21	58	58	6,010
23.160.50.32	32		60	24	78	-	4,340
23.160.50.32/150	32		150	24	78	63	6,400
23.160.50.40	40		65	27	88	-	5,250
23.160.50.40/150	40		150	27	88	73	9,130
23.160.50.50	50	65	30	90	-	5,560	

REF.			
23.160.40.16	10008	86016	11103
23.160.40.16/100	10008	86016	11103
23.160.40.22	10010	86022	11004
23.160.40.22/100	10010	86022	11004
23.160.40.27	10012	86027	11005
23.160.40.27/100	10012	86027	11005
23.160.40.32	10016	86032	11105
23.160.40.32/125	10016	86032	11105
23.160.40.40	10020	86040	11006
23.160.50.16	10008	86016	11108
23.160.50.16/150	10008	86016	11108
23.160.50.22	10010	86022	11004
23.160.50.22/150	10010	86022	11004
23.160.50.27	10012	86027	11005
23.160.50.27/150	10012	86027	11005
23.160.50.32	10016	86032	11105
23.160.50.32/150	10016	86032	11105
23.160.50.40	10020	86040	11006
23.160.50.40/150	10020	86040	11006
23.160.50.50	10024	86050	11008



REF.	K ISO	d <sub>1</sub> h6 mm	A mm	L mm	D mm	l <sub>1</sub> mm	d <sub>2</sub> mm				
A20.160.40.16/150	40	16	150	96	50	17	36	10008	86016	11103	2,300
A20.160.40.16/200		16	200	146	50	17	36	10008	86016	11103	2,800
A20.160.40.16/250		16	250	196	50	17	36	10008	86016	11103	3,310
A20.160.40.16/300		16	300	246	50	17	36	10008	86016	11103	4,030
A20.160.40.22/150		22	150	96	50	19	44	10010	86022	11004	2,710
A20.160.40.22/200		22	200	146	50	19	44	10010	86022	11004	3,400
A20.160.40.22/250		22	250	196	50	19	44	10010	86022	11004	4,090
A20.160.40.22/300		22	300	246	50	19	44	10010	86022	11004	4,830
A20.160.40.27/150		27	150	96	56	21	54	10012	86027	11005	3,410
A20.160.40.27/200		27	200	146	56	21	54	10012	86027	11005	4,210
A20.160.40.27/250		27	250	196	56	21	54	10012	86027	11005	5,100
A20.160.40.27/300		27	300	246	56	21	54	10012	86027	11005	5,990
A20.160.50.16/150	50	16	150	92	80	17	36	10008	86016	11103	5,460
A20.160.50.16/200		16	200	142	80	17	36	10008	86016	11103	6,020
A20.160.50.16/250		16	250	192	80	17	36	10008	86016	11103	6,730
A20.160.50.16/300		16	300	242	80	17	36	10008	86016	11103	7,580
A20.160.50.16/400	16	400	342	80	17	36	10008	86016	11103	11,240	
A20.160.50.22/200		22	200	142	80	19	44	10010	86022	11004	6,260
A20.160.50.22/250		22	250	192	80	19	44	10010	86022	11004	7,360
A20.160.50.22/300		22	300	242	80	19	44	10010	86022	11004	7,940
A20.160.50.22/400		22	400	342	80	19	44	10010	86022	11004	9,780
A20.160.50.22/500	22	500	442	80	19	44	10010	86022	11004	12,240	
A20.160.50.27/200		27	200	142	80	21	54	10012	86027	11005	7,230
A20.160.50.27/250		27	250	192	80	21	54	10012	86027	11005	8,240
A20.160.50.27/300		27	300	242	80	21	54	10012	86027	11005	9,290
A20.160.50.27/400		27	400	342	80	21	54	10012	86027	11005	11,430
A20.160.50.27/500	27	500	442	80	21	54	10012	86027	11005	14,460	
A20.160.50.32/200		32	200	142	80	24	64	10016	86032	11105	8,340
A20.160.50.32/250		32	250	192	80	24	64	10016	86032	11105	9,720
A20.160.50.32/300		32	300	242	80	24	64	10016	86032	11105	11,380
A20.160.50.32/400		32	400	342	80	24	64	10016	86032	11105	17,000
A20.160.50.32/500	32	500	442	80	24	64	10016	86032	11105	18,000	

**SPECIAL FOR MOULD AND DIE MAKERS  
BESONDERS EMPFOHLEN FÜR WERKZEUG-  
UND FORMENBAU**

Vibration reduced up to 60% compared to any other conventional shell mill adaptor, as they are manufactured with materials and mechanisms having antivibration properties.



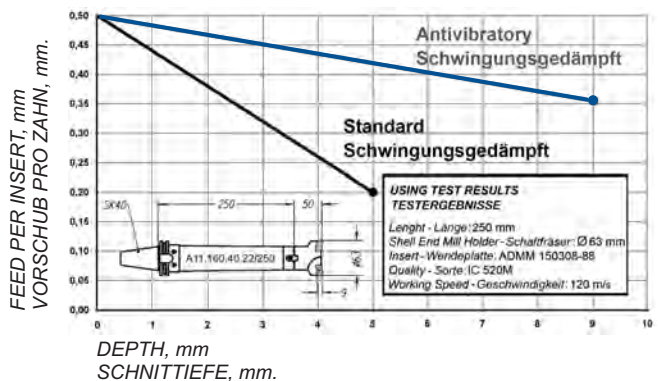

60% weniger Schwingungen im Vergleich mit anderen herkömmlichen Aufsteckfräsdorne, da diese mit Materialien und Mechanismen hergestellt worden sind, die schwingungsdämpfende Eigenschaften haben.

**COMPARISON WHEN USING AN ANTIVIBRATORY TOOLHOLDER  
VERGLEICH WENN MAN EINEN SCHWINGUNGSGEDÄMPFTEN  
AUFSTECKFRÄSDORN VERWENDET**

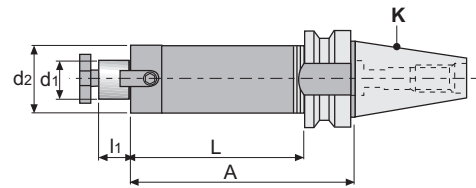





REF.	K ISO	d <sub>1</sub> h6 mm	A mm	L mm	l <sub>1</sub> mm	d <sub>2</sub> mm				
A20.160.40.16/150-39	40	16	150	96	17	39	10008	86016	11103	
A20.160.40.16/200-39		16	200	146	17	39	10008	86016	11103	
A20.160.40.16/250-39		16	250	196	17	39	10008	86016	11103	
A20.160.40.16/300-39		16	300	246	17	39	10008	86016	11103	
A20.160.40.22/150-49		22	150	96	19	49	10010	86022	11004	
A20.160.40.22/200-49		22	200	146	19	49	10010	86022	11004	
A20.160.40.22/250-49		22	250	196	19	49	10010	86022	11004	
A20.160.40.22/300-49		22	300	246	19	49	10010	86022	11004	
A20.160.40.27/150-62		27	150	96	21	62	10012	86027	11005	
A20.160.40.27/200-62		27	200	146	21	62	10012	86027	11005	
A20.160.40.27/250-62		27	250	196	21	62	10012	86027	11005	
A20.160.40.27/300-62		27	300	246	21	62	10012	86027	11005	
A20.160.50.16/150-39	50	16	150	92	17	39	10008	86016	11103	
A20.160.50.16/200-39		16	200	142	17	39	10008	86016	11103	
A20.160.50.16/250-39		16	250	192	17	39	10008	86016	11103	
A20.160.50.16/300-39		16	300	242	17	39	10008	86016	11103	
A20.160.50.16/400-39		16	400	342	17	39	10008	86016	11103	
A20.160.50.22/200-49		22	200	142	19	49	10010	86022	11004	
A20.160.50.22/250-49		22	250	192	19	49	10010	86022	11004	
A20.160.50.22/300-49		22	300	242	19	49	10010	86022	11004	
A20.160.50.22/400-49		22	400	342	19	49	10010	86022	11004	
A20.160.50.22/500-49		22	500	442	19	49	10010	86022	11004	
A20.160.50.22/200-60		22	200	142	19	60	10010	86022	11004	
A20.160.50.22/250-60		22	250	192	19	60	10010	86022	11004	
A20.160.50.22/300-60		22	300	242	19	60	10010	86022	11004	
A20.160.50.22/400-60		22	400	342	19	60	10010	86022	11004	
A20.160.50.22/500-60		22	500	442	19	60	10010	86022	11004	
A20.160.50.27/200-62		27	200	142	21	62	10012	86027	11005	
A20.160.50.27/250-62		27	250	192	21	62	10012	86027	11005	
A20.160.50.27/300-62		27	300	242	21	62	10012	86027	11005	
A20.160.50.27/400-62		27	400	342	21	62	10012	86027	11005	
A20.160.50.27/500-62		27	500	442	21	62	10012	86027	11005	
A20.160.50.32/200-79		32	200	142	24	79	10016	86032	11105	
A20.160.50.32/250-79		32	250	192	24	79	10016	86032	11105	
A20.160.50.32/300-79		32	300	242	24	79	10016	86032	11105	
A20.160.50.32/400-79		32	400	342	24	79	10016	86032	11105	
A20.160.50.32/500-79		32	500	442	24	79	10016	86032	11105	

**SPECIAL FOR MOULD AND DIE MAKERS  
BESONDERS EMPFOHLEN FÜR WERKZEUG- UND FORMENBAU**

Vibration reduced up to 60% compared to any other conventional shell mill adaptor, as they are manufactured with materials and mechanisms having antivibration properties.

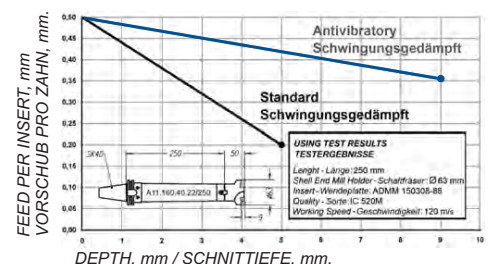

60% weniger Schwingungen im Vergleich mit anderen herkömmlichen Aufsteckfräsdorne, da diese mit Materialien und Mechanismen hergestellt worden sind, die schwingungsdämpfende Eigenschaften haben.

COMPARISON WHEN USING AN ANTIVIBRATORY TOOL HOLDER  
VERGLEICH WENN MAN EINEN SCHWINGUNGSGEDÄMPFTEN AUFSTECKFRÄSDORN VERWENDET

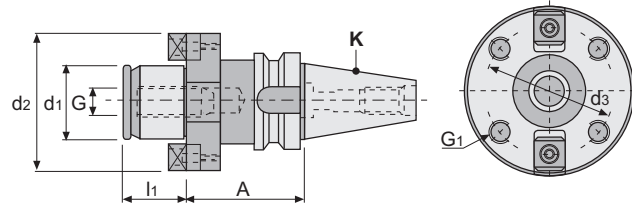



REF.	K ISO	d <sub>1</sub> g5 mm	A mm	d <sub>2</sub> mm	d <sub>3</sub> mm	G mm	G <sub>1</sub> mm	l <sub>1</sub> mm	⚖️ kg
20.165.40.40	40	40	60	89	66,7	M-20	M-12	30	2,700
20.165.50.40	50	40	70	89	66,7	M-20	M-12	30	5,510
20.165.50.60		60	80	129	101,6	M-30	M-16	40	8,100

REF.	2 x 	2 x 
20.165.40.40	80040	11006
20.165.50.40	80040	11006
20.165.50.60	80060	11012

20 23  
JIS B 6339-BT

25  
CHIRON

BORING HEADS  
BOHRKÖPFE

MORSE SHANKS  
MORSE SCHÄFTE



CYLINDRICAL SHANKS  
ZYLINDRISCHE SCHÄFTE

ACCESSORIES  
ZUBEHÖR

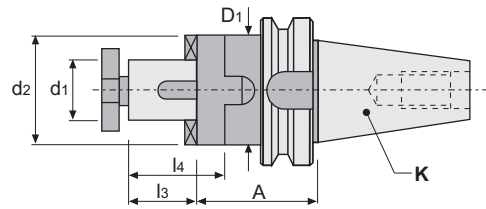



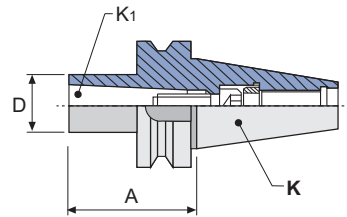

REF.	K ISO	d1 h6 mm	A mm	l3 mm	l4 mm	d2 mm	D1 mm	
20.180.30.16	30	16	50	17	27	32	-	0,620
20.180.30.22		22	50	19	31	40	-	0,790
20.180.30.27		27	55	21	33	48	-	0,730
20.180.40.16	40	16	55	17	27	32	-	1,260
20.180.40.16/100		16	100	17	27	32	35	-
20.180.40.22		22	55	19	31	40	-	1,390
20.180.40.22/100		22	100	19	31	40	48	1,970
20.180.40.27		27	55	21	33	48	-	1,560
20.180.40.27/100		27	100	21	33	48	48	2,170
20.180.40.32		32	60	24	38	58	-	1,560
20.180.40.32/100		32	100	24	38	58	58	2,780
20.180.40.40		40	60	27	41	70	-	1,800
20.180.50.16	50	16	70	17	27	32	-	4,100
20.180.50.16/125		16	125	17	27	32	35	4,480
20.180.50.22		22	70	19	31	40	-	4,230
20.180.50.22/125		22	125	19	31	40	48	4,950
20.180.50.27		27	70	21	33	48	-	4,170
20.180.50.27/125		27	125	21	33	48	60	5,420
20.180.50.32		32	70	24	38	58	-	4,360
20.180.50.32/125		32	125	24	38	58	78	6,270
20.180.50.40		40	70	27	41	70	-	4,520
20.180.50.40/125		40	125	27	41	70	78	6,950
20.180.50.50		50	70	30	46	90	-	5,000

REF.			
20.180.30.16	10008	60116	88016
20.180.30.22	10010	60122	88022
20.180.30.27	10012	60127	88027
20.180.40.16	10008	60116	88016
20.180.40.16/100	10008	60116	88016
20.180.40.22	10010	60122	88022
20.180.40.22/100	10010	60122	88022
20.180.40.27	10012	60127	88027
20.180.40.27/100	10012	60127	88027
20.180.40.32	10016	60132	88032
20.180.40.32/100	10016	60132	88032
20.180.40.40	10020	60140	88040
20.180.50.16	10008	60116	88016
20.180.50.16/125	10008	60116	88016
20.180.50.22	10010	60122	88022
20.180.50.22/125	10010	60122	88022
20.180.50.27	10012	60127	88027
20.180.50.27/125	10012	60127	88027
20.180.50.32	10016	60132	88032
20.180.50.32/125	10016	60132	88032
20.180.50.40	10020	60140	88040
20.180.50.40/125	10020	60140	88040
20.180.50.50	10024	60150	88050



REF.	K ISO	K <sub>1</sub> MORSE	A mm	D mm	kg
20.210.30.01	30	1	50	25	0,510
20.210.30.02		2	65	32	0,590
20.210.30.03		3	80	40	0,760
20.210.40.01	40	1	50	25	1,080
20.210.40.02		2	50	32	1,130
20.210.40.03		3	70	40	1,270
20.210.40.04		4	95	48	1,520
20.210.50.01	50	1	45	25	3,850
20.210.50.02		2	60	32	3,860
20.210.50.03		3	65	40	3,870
20.210.50.04		4	70	48	3,870
20.210.50.05		5	100	63	4,020

REF.			
20.210.30.01	16105	19312	11106
20.210.30.02	16105	19315	12110
20.210.30.03	16105	19318	12012
20.210.40.01	16205	19516	11206
20.210.40.02	16205	19416	18010
20.210.40.03	16205	19420	11312
20.210.40.04	16205	19322	12016
20.210.50.01	16205	19624	11206
20.210.50.02	16205	19324	11110
20.210.50.03	16205	19524	11212
20.210.50.04	16205	19424	12016
20.210.50.05	16205	19338	11020

**REDUCING ADAPTORS**



for tools with Morse taper shank and drawbar thread DIN 228-A

**REDUZIERHÜLSEN**

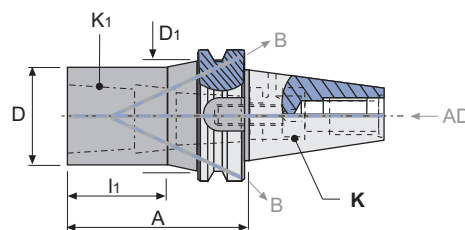
für Werkzeuge mit Morsekegel und Anzugsgewinde DIN 228-A

SIMILAR / ÄHNLICH WIE  
DIN 69871 - Form AD+B

REF.	K ISO	K <sub>1</sub> MORSE	A mm	D mm	D <sub>1</sub> mm	l <sub>1</sub> mm	⚖ Kg
23.210.40.01	40	1	50	25	45	16	-
23.210.40.02		2	50	32	50	19	1,090
23.210.40.03		3	70	40	50	42	1,270
23.210.40.04		4	95	48			1,480
23.210.50.01	50	1	45	25	80	16	-
23.210.50.02		2	60	32	80	23	3,920
23.210.50.03		3	65	40	80	28	3,910
23.210.50.04		4	70	48	80	37	3,790
23.210.50.05		5	100	63	80	66	4,080

REF.		REF.		
23.210.40.01	16205		19516	18006
23.210.40.02	16205		19416	18010
23.210.40.03	16205		19420	18012
23.210.40.04	16205		19322	18016
23.210.50.01	16205		19624	18006
23.210.50.02	16205		19324	18110
23.210.50.03	16205		19524	18112
23.210.50.04	16205		19424	18016
23.210.50.05	16205		19338	18020

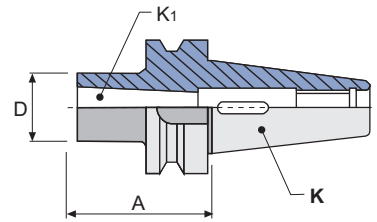

REF.	K ISO	K <sub>1</sub> MORSE	A mm	D mm	⚖️ kg
20.215.30.01	30	1	50	25	0,470
20.215.30.02		2	62	32	0,530
20.215.30.03		3	78	40	0,600
20.215.40.01	40	1	50	25	1,060
20.215.40.02		2	50	32	1,070
20.215.40.03		3	70	40	1,180
20.215.40.04		4	95	48	1,390
20.215.50.01	50	1	45	25	3,750
20.215.50.02		2	60	32	3,770
20.215.50.03		3	65	40	3,800
20.215.50.04		4	95	48	4,000
20.215.50.05		5	105	63	4,100

20 23  
JIS B 6339-BT

25  
CHIRON

BORING HEADS  
BOHRKÖPFE

MORSE SHANKS  
MORSE SCHÄFTE

CYLINDRICAL SHANKS  
ZYLINDRISCHE SCHÄFTE

ACCESSORIES  
ZUBEHÖR

**REDUCING ADAPTORS**

for tools with Morse taper and tang DIN 228-B shank

**REDUZIERHÜLSEN**

für Werkzeuge mit Morsekegel und Austreibblappen DIN 228-B

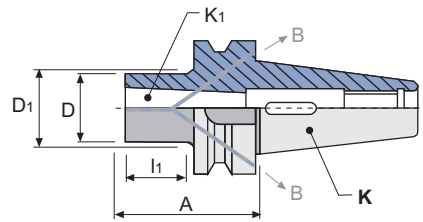
SIMILAR / ÄHNLICH WIE  
DIN 69871 - Form AD+B

REF.	K ISO	K <sub>1</sub> MORSE	A mm	D mm	D <sub>1</sub> mm	I <sub>1</sub> mm	
23.215.40.01	40	1	50	25	45	16	1,080
23.215.40.02		2	50	32	50	18	1,080
23.215.40.03		3	70	40	50	42	1,170
23.215.40.04		4	95	48			1,380
23.215.50.01	50	1	45	25	80	16	3,730
23.215.50.02		2	60	32	80	23	3,650
23.215.50.03		3	65	40	80	28	3,930
23.215.50.04		4	95	48	80	49	3,930
23.215.50.05		5	105	63	80	71	3,830

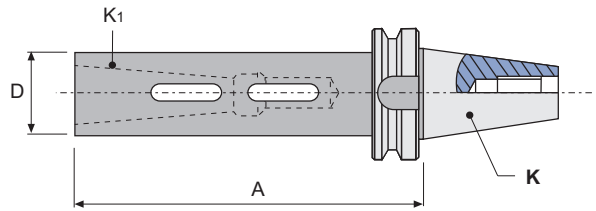

REF.	K ISO	K <sub>1</sub> MORSE	A mm	D mm	⚖ kg
20.216.30.01	30	1	115	25	0,760
20.216.30.02		2	125	32	0,930
20.216.30.03		3	145	40	1,320
20.216.40.01	40	1	115	25	1,250
20.216.40.02		2	125	32	1,540
20.216.40.03		3	145	40	1,890
20.216.40.04		4	165	48	2,270
20.216.50.01	50	1	120	25	4,100
20.216.50.02		2	135	32	4,290
20.216.50.03		3	155	40	4,650
20.216.50.04		4	180	48	5,130
20.216.50.05		5	215	63	-

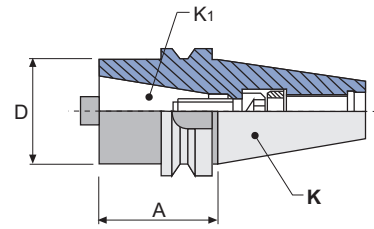

REF.	K ISO	K <sub>1</sub> DIN 2080	A mm	D mm	Kg
20.225.40.30	40	30	50	50	1,200
20.225.40.40		40	100	63	2,230
20.225.50.30	50	30	50	50	3,810
20.225.50.40		40	70	63	3,980
20.225.50.50		50	120	97	6,440

REF.	K ISO	K <sub>1</sub> DIN 69871 JIS B 6339-BT	A mm	D mm	Kg
20.226.40.30	40	30	50	50	1,210
20.226.40.40		40	100	63	2,250
20.226.50.30	50	30	50	50	3,840
20.226.50.40		40	70	63	4,090
20.226.50.50		50	120	97	6,580

REF.		REF.		
20.225.40.30	16205		19320	11312
20.225.40.40	16205		19322	12016
20.226.40.30	16205		19320	11412
20.226.40.40	16205		19322	12116
20.225.50.30	16205		19524	11112
20.225.50.40	16205		19424	12016
20.225.50.50	16205		19438	12024
20.226.50.30	16205		19524	11412
20.226.50.40	16205		19424	12116
20.226.50.50	16205		19438	12124

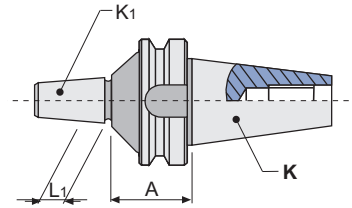

REF.	K ISO	K1 DIN	A mm	d1 mm	kg
20.290.30.12	30	B-12	27	12,065	0,460
20.290.30.16		B-16	27	15,733	-
20.290.40.12	40	B-12	32	12,065	1,070
20.290.40.16		B-16	32	15,733	1,090
20.290.40.18		B-18	32	17,780	1,100
20.290.50.16	50	B-16	43	15,733	3,880
20.290.50.18		B-18	43	17,780	3,790

REF.	ACCESSORIES / ZUBEHÖR
MU	Standard keyless drill chucks DIN 238 / Standard Schnellspann-Bohrfutter DIN 238
MP	Precision keyless drill chucks DIN 238 / Schnellspann-Bohrfutter DIN 238, Genauigkeitsausführung
MK	Self clamping precision keyless drill chucks DIN 238 / Selbstspann-Bohrfutter DIN 238, Genauigkeitsausführung
MH	CNC-UNIVERSAL precision drill chucks DIN 238 / CNC-Universaler Bohrfutter DIN 238, Genauigkeitsausführung



MU



MP



MK



MH

For more information see page / Für weitere Informationen siehe Seite: K.02, K.03, K.04, K.05



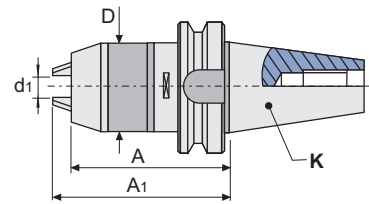

REF.	K ISO	d <sub>1</sub> mm	D mm	A mm	A <sub>1</sub> max mm	kg
20.295.30.08	30	0 - 8	35,5	74	82	0,990
20.295.40.08	40	0 - 8	35,5	75	83	1,320
20.295.40.13		0-13	51,0	92	103	1,570
20.295.40.16		3-16	58,0	112	125	2,320
20.295.50.13	50	0-13	51,0	102	113	4,250
20.295.50.16		3-16	58,0	105	118	-

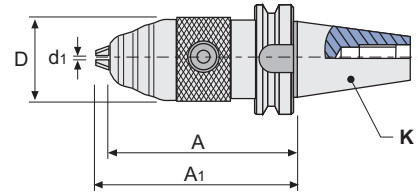

\* SUPPLIED WITH WRENCH / \* GELIEFERT MIT SCHLÜSSEL

REF.			3 x
20.295.30.08	50008	11206	60308
20.295.40.08	50008	11206	60308
20.295.40.13	50013	11108	60313
20.295.40.16	50016	11108	60313
20.295.50.13	50013	11108	60313
20.295.50.16	50016	11108	60313



REF.	K ISO	d <sub>1</sub> mm	D mm	A mm	A <sub>1</sub> max mm	kg
20.296.30.13	30	1-13	50	86,4	93,4	1,150
20.296.40.13	40	1-13	50	89,4	96,4	1,720
20.296.40.16		3-16	56	96,4	103,4	2,150
20.296.50.13	50	1-13	50	100,4	107,4	4,520
20.296.50.16		3-16	56	107,4	114,4	4,780

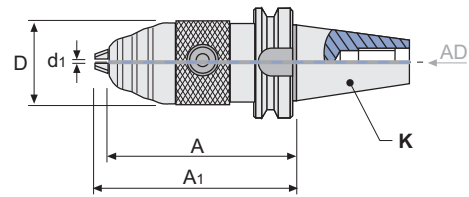

\* SUPPLIED WITH WRENCH / \* GELIEFERT MIT SCHLÜSSEL

REF.		3 x 
20.296.30.13	50706	60313
20.296.40.13	50706	60313
20.296.40.16	50706	60313
20.296.50.13	50706	60313
20.296.50.16	50706	60313



REF.	K ISO	d <sub>1</sub> mm	D mm	A mm	A <sub>1</sub> max mm	
23.296.30.13	30	1-13	50	86,4	93,4	-
23.296.40.13	40	1-13	50	89,4	96,4	1,700
23.296.40.16		3-16	56	96,4	103,4	-
23.296.50.13	50	1-13	50	100,4	107,4	4,390
23.296.50.16		3-16	56	107,4	114,4	4,660

\* SUPPLIED WITH WRENCH / \* GELIEFERT MIT SCHLÜSSEL

REF.		3 x 
23.296.30.13	50706	60313
23.296.40.13	50706	60313
23.296.40.16	50706	60313
23.296.50.13	50706	60313
23.296.50.16	50706	60313

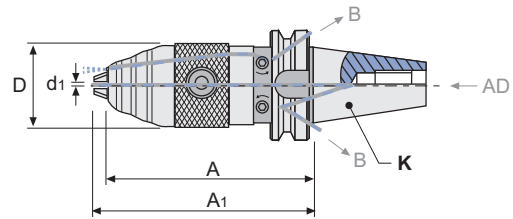



REF.	K ISO	d1 mm	D mm	A mm	A1 max mm	kg
23.297.40.13	40	1-13	56	113	120	2,320
23.297.40.16		3-16	56	120	131	2,500
23.297.50.13	50	1-13	56	114	121	5,010
23.297.50.16		3-16	56	121	132	-

The coolant can be supplied in different ways: through the coolant holes of the tool, through the front part of the drill chuck or through both parts simultaneously.

Das Kühlmittel kann auf verschiedenen Weisen verteilt werden: durch die Kühlmittel-Löcher des Werkzeugs, durch den Vorderteil des Bohrfutters oder durch beide Teile gleichzeitig.

**\* SUPPLIED WITH WRENCH / \* GELIEFERT MIT SCHLÜSSEL**

REF.		3 x 
23.297.40.13	50706	60313
23.297.40.16	50706	60313
23.297.50.13	50706	60313
23.297.50.16	50706	60313

20 23  
JIS B 6339-BT

25  
CHIRON



BORING HEADS  
BOHRKÖPFE

MORSE SHANKS  
MORSE SCHÄFTE

CYLINDRICAL SHANKS  
ZYLINDRISCHE SCHÄFTE

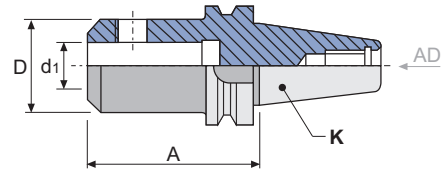
ACCESSORIES  
ZUBEHÖR



REF.	K ISO	d <sub>1</sub> H4 mm	A mm	D mm		
20.300.30.06	30	6	50	25	15106	0,470
20.300.30.08		8	50	28	15108	-
20.300.30.10		10	50	35	15110	0,550
20.300.30.12		12	50	42	15212	0,620
20.300.30.14		14	50	44	15212	0,650
20.300.30.16		16	63	48	15314	0,660
20.300.30.18		18	63	50	15314	0,810
20.300.40.06	40	6	50	25	15106	1,070
20.300.40.08		8	50	28	15108	1,090
20.300.40.10		10	63	35	15110	1,210
20.300.40.12		12	63	42	15212	1,310
20.300.40.14		14	63	44	15212	1,330
20.300.40.16		16	63	48	15314	1,380
20.300.40.18		18	63	50	15314	1,410
20.300.40.20		20	63	52	15216	1,420
20.300.40.25		25	90	65	2 x 15218	2,240
20.300.40.32		32	100	72	2 x 15220	2,850
20.300.40.40		40	110	90	2 x 15220	4,000
20.300.50.06	50	6	63	25	15106	3,780
20.300.50.08		8	63	28	15108	3,820
20.300.50.10		10	65	35	15110	3,880
20.300.50.12		12	80	42	15212	4,010
20.300.50.14		14	80	44	15212	4,030
20.300.50.16		16	80	48	15314	4,120
20.300.50.18		18	80	50	15314	4,200
20.300.50.20		20	80	52	15216	4,170
20.300.50.25		25	100	65	2 x 15218	4,850
20.300.50.32		32	105	72	2 x 15220	5,250
20.300.50.40		40	120	90	2 x 15220	6,580
20.300.50.50		50	120	98	2 x 15024	6,930

REF.	ACCESSORIES / ZUBEHÖR
42.300	Short and long reducing bushings DIN 1835-B Form A and B / Kurze und lange Reduzierhülsen DIN 1835-B Form A und B
42.311	Short and long reducing bushings DIN 1835-B Form C / Kurze und lange Reduzierhülsen DIN 1835-B Form C



42.300





42.311

For more information see page / Für weitere Informationen siehe Seite: J.11, J.12

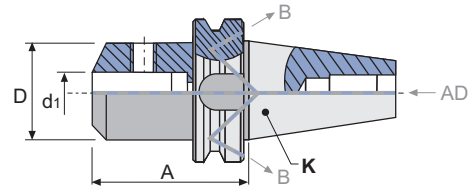
SIMILAR / ÄHNLICH WIE  
DIN 69871 - Form AD+B



REF.	K ISO	d <sub>1</sub> H4 mm	A mm	D mm		
23.300.40.06	40	6	50	25	15106	1,070
23.300.40.08		8	50	28	15108	1,090
23.300.40.10		10	63	35	15110	1,230
23.300.40.12		12	63	42	15212	1,300
23.300.40.14		14	63	44	15212	1,320
23.300.40.16		16	63	48	15314	1,380
23.300.40.18		18	63	50	15314	1,390
23.300.40.20		20	63	52	15216	1,410
23.300.40.25		25	90	65	2 x 15218	2,250
23.300.40.32		32	100	72	2 x 15220	2,730
23.300.40.40		40	110	90	2 x 15220	3,960
23.300.50.06		50	6	63	25	15106
23.300.50.08	8		63	28	15108	3,790
23.300.50.10	10		65	35	15110	3,850
23.300.50.12	12		80	42	15212	4,000
23.300.50.14	14		80	44	15212	4,020
23.300.50.16	16		80	48	15314	4,100
23.300.50.18	18		80	50	15314	4,200
23.300.50.20	20		80	52	15216	4,250
23.300.50.25	25		100	65	2 x 15218	4,870
23.300.50.32	32		105	72	2 x 15220	5,180
23.300.50.40	40		120	90	2 x 15220	5,900
23.300.50.50	50		120	98	2 x 15024	6,930

REF.	ACCESSORIES / ZUBEHÖR
42.300	Short and long reducing bushings DIN 1835-B Form A and B / Kurze und lange Reduzierhülsen DIN 1835-B Form A und B
42.311	Short and long reducing bushings DIN 1835-B Form C / Kurze und lange Reduzierhülsen DIN 1835-B Form C



42.300



42.311

For more information see page / Für weitere Informationen siehe Seite: J.11, J.12

**SHORT END MILL ADAPTORS**

for cutters and tooling with cylindrical shank and weldon flat DIN 1835-B

**KURZE AUFSTECKFRÄSDORNE**

für Fräser und Werkzeuge mit zylindrischem Schaft und Weldon-Fläche DIN 1835-B

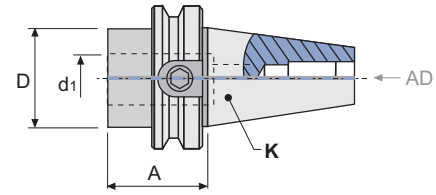



REF.	K ISO	d <sub>1</sub> H4 mm	A mm	D mm	kg
20.302.30.16	30	16	32	32	0,400
20.302.30.20		20	34	36	0,370
20.302.40.16	40	16	35	44	1,060
20.302.40.20		20	35	44	1,000
20.302.40.25		25	35	44	0,920
20.302.40.32		32	35	44	-
20.302.50.16		50	16	44	70
20.302.50.20	20		44	70	3,730
20.302.50.25	25		44	70	3,620
20.302.50.32	32		44	70	3,470

REF.	
20.302.30.16	15114
20.302.30.20	15014
20.302.40.16	15214
20.302.40.20	15116
20.302.40.25	15016
20.302.40.32	15020
20.302.50.16	15314
20.302.50.20	15216
20.302.50.25	15118 + 15218
20.302.50.32	15020 + 15120

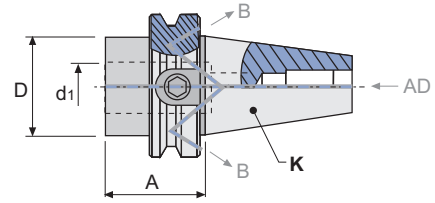
SIMILAR / ÄHNLICH WIE  
DIN 69871 - Form AD+B



REF.	K ISO	d <sub>1</sub> H4 mm	A mm	D mm		
23.302.40.16	40	16	35	44	15214	1,070
23.302.40.20		20	35	44	15116	0,990
23.302.40.25		25	35	44	15016	0,890
23.302.40.32		32	35	44	15020	-
23.302.50.16	50	16	44	70	15314	3,880
23.302.50.20		20	44	70	15216	3,710
23.302.50.25		25	44	70	15118 + 15218	3,620
23.302.50.32		32	44	70	15020 + 15120	3,450

REF.	ACCESSORIES / ZUBEHÖR
42.610	Tapping head with axial compensation DIN 1835-B / Gewindefutter, mit Längenausgleich DIN 1835-B
42.620	Quick change tapping head with axial compensation DIN 1835-B+E / Gewindefutter-Schnellwechselfutter mit Längenausgleich DIN 1835-B + E



42.610



42.620

For more information see page / Für weitere Informationen siehe Seite: J.14, J.15







**END MILL ADAPTORS TYPE WHISTLE-NOTCH**

for tools with cylindrical shank and tightening inclined flat DIN 1835-E

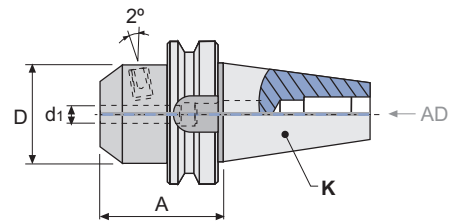
**ZYLINDERSCHAFT-AUFNAHME TYP WHISTLE-NOTCH**



für Werkzeuge mit zylindrischem Schaft und geneigte Spannfläche DIN 1835-E

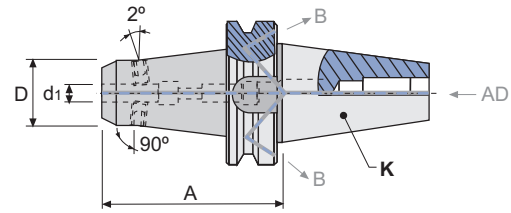

REF.	K ISO	d <sub>1</sub> H4 mm	A mm	D mm			
20.305.30.06	30	6	50	25	19005	15106	0,550
20.305.30.08		8	50	28	19106	15108	0,540
20.305.30.10		10	50	35	19008	15110	0,590
20.305.30.12		12	50	42	19110	15212	0,660
20.305.30.14		14	50	44	19110	15212	0,630
20.305.30.16		16	50	48	19012	15314	0,650
20.305.30.18		18	60	50	19012	15314	0,820
20.305.40.06	40	6	50	25	19005	15106	1,100
20.305.40.08		8	50	28	19106	15108	1,140
20.305.40.10		10	63	35	19008	15110	1,260
20.305.40.12		12	50	42	19110	15212	1,320
20.305.40.14		14	50	44	19110	15212	1,360
20.305.40.16		16	63	48	19012	15314	1,430
20.305.40.18		18	63	50	19012	15314	1,440
20.305.40.20		20	63	52	19016	15216	1,430
20.305.40.25		25	90	65	19020	2 x 15218	2,240
20.305.40.32		32	100	72	19020	2 x 15220	2,730
20.305.50.06	50	6	63	25	19005	15106	3,700
20.305.50.08		8	63	28	19106	15108	3,730
20.305.50.10		10	65	35	19008	15110	3,810
20.305.50.12		12	80	42	19110	15212	4,160
20.305.50.14		14	80	44	19110	15212	4,070
20.305.50.16		16	80	48	19012	15314	4,110
20.305.50.18		18	80	50	19012	15314	4,190
20.305.50.20		20	80	52	19016	15216	4,170
20.305.50.25		25	100	65	19020	2 x 15218	5,010
20.305.50.32		32	105	72	19020	2 x 15220	5,270
20.305.50.40		40	120	90	19020	2 x 15220	6,650

SIMILAR / ÄHNLICH WIE  
DIN 69871 - Form AD+B

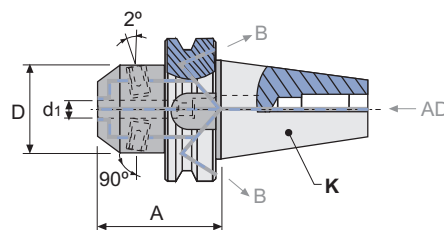

REF.	K ISO	d <sub>1</sub> H4 mm	A mm	D mm	D <sub>1</sub> mm	2 x 	
23.306.40.06/100	40	6	100	22	28	15006	1,240
23.306.40.06/130		6	130	22	28	15006	1,340
23.306.40.06/160		6	160	22	33	15006	1,560
23.306.40.08/100		8	100	24	30	15008	1,270
23.306.40.08/130		8	130	24	30	15008	1,420
23.306.40.08/160		8	160	24	35	15008	1,620
23.306.40.10/100		10	100	30	38	15010	1,460
23.306.40.10/130		10	130	30	38	15010	1,630
23.306.40.10/160		10	160	30	39	15010	1,850
23.306.40.12/100		12	100	32	40	15012	1,440
23.306.40.12/130		12	130	32	40	15012	1,730
23.306.40.12/160		12	160	32	43	15012	1,950
23.306.40.14/100		14	100	32	40	15012	1,470
23.306.40.14/130		14	130	32	40	15012	1,650
23.306.40.14/160		14	160	32	44	15012	2,200
23.306.40.16/100		16	100	36	44	15114	1,580
23.306.40.16/130		16	130	36	44	15114	1,830
23.306.40.16/160		16	160	36	44	15114	2,100
23.306.40.18/100		18	100	38	46	15114	1,600
23.306.40.18/130		18	130	38	46	15114	1,900
23.306.40.18/160		18	160	38	46	15114	2,700
23.306.40.20/100		20	100	44	50	15116	1,710
23.306.40.20/130		20	130	44	50	15116	2,070
23.306.40.20/160		20	160	44	50	15018	2,490
23.306.40.25/130		25	130	50	50	15018	2,240
23.306.40.25/160		25	160	50	50	15018	2,660
23.306.50.06/130	50	6	130	22	28	15006	3,970
23.306.50.06/160		6	160	22	33	15006	4,140
23.306.50.06/200		6	200	22	36	15006	4,440
23.306.50.08/130		8	130	24	30	15008	3,950
23.306.50.08/160		8	160	24	35	15008	4,240
23.306.50.08/200		8	200	24	38	15008	4,530
23.306.50.10/130		10	130	30	38	15010	4,250
23.306.50.10/160		10	160	30	39	15010	4,470
23.306.50.10/200		10	200	30	43	15010	4,900
23.306.50.12/130		12	130	32	40	15012	4,270
23.306.50.12/160		12	160	32	43	15012	4,570
23.306.50.12/200		12	200	32	46	15012	4,980
23.306.50.14/130		14	130	32	40	15012	4,230
23.306.50.14/160		14	160	32	44	15012	4,490
23.306.50.14/200		14	200	32	48	15012	5,100
23.306.50.16/130		16	130	36	44	15114	4,340
23.306.50.16/160		16	160	36	44	15114	4,610
23.306.50.16/200		16	200	36	50	15114	5,230
23.306.50.18/130		18	130	38	46	15114	4,390
23.306.50.18/160		18	160	38	46	15114	4,770
23.306.50.18/200		18	200	38	52	15114	5,340
23.306.50.20/130		20	130	44	50	15116	4,640
23.306.50.20/160		20	160	44	50	15116	4,950
23.306.50.20/200		20	200	44	55	15116	5,650
23.306.50.25/130		25	130	50	56	4 x 15018	4,800
23.306.50.25/160		25	160	50	60	4 x 15018	5,440
23.306.50.25/200		25	200	50	64	4 x 15018	6,270
23.306.50.32/200		32	200	58	72	4 x 15120	7,050

SIMILAR / ÄHNLICH WIE  
DIN 69871 - Form AD+B

REF.	K ISO	d <sub>1</sub> H4 mm	A mm	D mm	Ⓚ kg
23.307.40.06	40	6	50	25	1,080
23.307.40.08		8	50	28	1,130
23.307.40.10		10	63	35	-
23.307.40.12		12	63	42	-
23.307.40.14		14	63	44	-
23.307.40.16		16	63	48	1,440
23.307.40.18		18	63	50	-
23.307.40.20		20	63	52	-
23.307.40.25		25	90	65	-
23.307.40.32		32	100	72	2,700
23.307.50.06	50	6	63	25	3,850
23.307.50.08		8	63	28	-
23.307.50.10		10	65	35	3,950
23.307.50.12		12	80	42	-
23.307.50.14		14	80	44	-
23.307.50.16		16	80	48	-
23.307.50.18		18	80	50	4,290
23.307.50.20		20	80	52	-
23.307.50.25		25	100	65	4,950
23.307.50.32		32	105	72	5,310
23.307.50.40		40	120	90	6,770

Coolant distribution trough the central or trough lateral part of the tool. / Kühlmittel-Verteilung durch die Mitte oder durch den seitlichen Teil des Werkzeugs.

REF.		2 x
23.307.40.06	19005	15106
23.307.40.08	19106	15108
23.307.40.10	19008	15110
23.307.40.12	19110	15212
23.307.40.14	19110	15212
23.307.40.16	19012	15314
23.307.40.18	19012	15314
23.307.40.20	19016	15216
23.307.40.25	19020	4 x 15218
23.307.40.32	19020	4 x 15220
23.307.50.06	19005	15106
23.307.50.08	19106	15108
23.307.50.10	19008	15110
23.307.50.12	19110	15212
23.307.50.14	19110	15212
23.307.50.16	19012	15314
23.307.50.18	19012	15314
23.307.50.20	19016	15216
23.307.50.25	19020	4 x 15218
23.307.50.32	19020	4 x 15220
23.307.50.40	19020	4 x 15220

SIMILAR / ÄHNLICH WIE  
DIN 69871 - Form AD+B

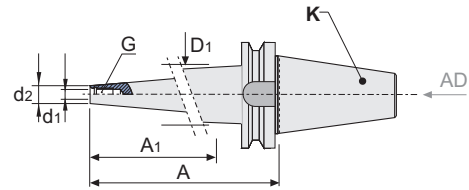

REF.	K ISO	A mm	d <sub>1</sub> mm	G mm	d <sub>2</sub> mm	A <sub>1</sub> mm	D <sub>1</sub> mm	Ⓚ <sub>kg</sub>
23.315.40.10/055	40	55	10,5	M10	18	25	20	1,040
23.315.40.10/080		80	10,5	M10	18	50	23	-
23.315.40.10/130		130	10,5	M10	18	100	29	1,350
23.315.40.12/055		55	12,5	M12	21	25	24	1,100
23.315.40.12/080		80	12,5	M12	21	50	26	-
23.315.40.12/130		130	12,5	M12	21	100	32	1,430
23.315.40.16/055		55	17,0	M16	29	25	32	1,100
23.315.40.16/080		80	17,0	M16	29	50	35	-
23.315.40.16/130		130	17,0	M16	29	100	40	1,710
23.315.50.12/090	50	90	12,5	M12	21	50	26	4,100
23.315.50.12/140		140	12,5	M12	21	100	32	4,150
23.315.50.12/190		190	12,5	M12	21	150	37	4,480
23.315.50.16/090		90	17,0	M16	29	50	35	3,950
23.315.50.16/140		140	17,0	M16	29	100	40	-
23.315.50.16/190		190	17,0	M16	29	150	45	4,950

REF.	ACCESSORIES / ZUBEHÖR
06.315	Front contact extensions for modular tools. / Stirnverlängerung für Einschraubfräser.
06.315	Front contact reducers for modular tools. / Stirnreduzierhülsen für Einschraubfräser.



06.315



06.315

For more information see page / Für weitere Informationen siehe Seite: J.02, J.03

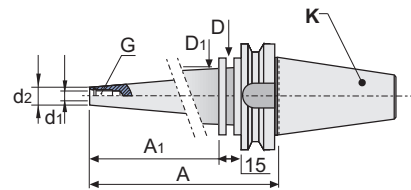

REF.	K ISO	A <sub>1</sub> mm	D mm	D <sub>1</sub> mm	A mm	d <sub>1</sub> mm	G mm	d <sub>2</sub> mm	⚖ kg
A20.315.40.10/200	40	158	50	35	200	10,5	M10	18	1,970
A20.315.40.10/250		208	50	40	250	10,5	M10	18	2,260
A20.315.40.10/300		258	50	45	300	10,5	M10	18	2,820
A20.315.40.12/200		158	50	38	200	12,5	M12	21	2,000
A20.315.40.12/250		208	50	43	250	12,5	M12	21	2,490
A20.315.40.12/300		258	50	44	300	12,5	M12	21	3,130
A20.315.40.16/200		158	50	43	200	17,0	M16	29	2,490
A20.315.40.16/250		208	50	44	250	17,0	M16	29	2,810
A20.315.40.16/300		258	50	47	300	17,0	M16	29	3,450
A20.315.50.12/250		50	197	80	42	250	12,5	M12	21
A20.315.50.12/300	247		80	47	300	12,5	M12	21	5,910
A20.315.50.12/400	347		80	57	400	12,5	M12	21	7,580
A20.315.50.16/250	197		80	50	250	17,0	M16	29	-
A20.315.50.16/300	247		80	55	300	17,0	M16	29	6,800
A20.315.50.16/400	347		80	65	400	17,0	M16	29	9,000
A20.315.50.16/500	447		80	76	500	17,0	M16	29	12,000

Antivibratory Shell Mill Adaptors manufactured with materials and mechanisms having antivibration properties. Standard and extra long lengths, suitable for moulding and special manufactures.

Schwingungsgedämpfte Aufsteckfräsdorne werden mit Materialien und Mechanismen hergestellt, die schwingungsdämpfende Eigenschaften haben. Sie sind für Werkzeugbau und Sonderherstellungen geeignet.

**PRE-BALANCED / VORGEWUCHTET**

ISO-40: 15.000 r.p.m. G-6,3

ISO-50: 10.000 r.p.m. G-6,3

REF.	ACCESSORIES / ZUBEHÖR
06.315	Front contact extensions for modular tools. / Stirnverlängerung für Einschraubfräser.
06.315	Front contact reducers for modular tools. / Stirnreduzierhülsen für Einschraubfräser.







06.315

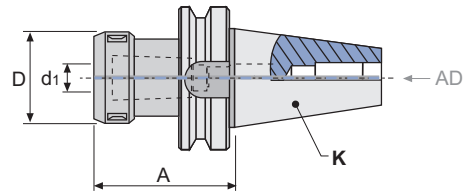

06.315

For more information see page / Für weitere Informationen siehe Seite: J.02, J.03



REF.	K ISO	A mm	d <sub>1</sub> mm	D mm				
20.353.30.16	30	65	2-16	43	35316	50116	19216	0,650
20.353.30.25		70	3-25	60	35325	50125	19216	0,830
20.353.40.16	40	70	2-16	43	35316	50116	19216	1,210
20.353.40.16/120		120	2-16	43	35316	50116	19216	1,580
20.353.40.25		70	3-25	60	35325	50125	19224	1,320
20.353.40.25/120		120	3-25	60	35325	50125	19224	1,880
20.353.40.32		90	4-32	72	35332	50132	19224	1,790
20.353.50.16	50	70	2-16	43	35316	50116	19216	3,850
20.353.50.16/120		120	2-16	43	35316	50116	19216	4,170
20.353.50.25		85	3-25	60	35325	50125	19224	4,100
20.353.50.25/140		140	3-25	60	35325	50125	19224	4,980
20.353.50.32		90	4-32	72	35332	50132	19230	4,220

\* If you want with ball bearing nut, see page: K.22  
 \* Wenn Sie diese mit Kugellager-Nute möchten, siehe Seite: K.22

\* SUPPLIED WITHOUT WRENCH / \* GELIEFERT OHNE SCHLÜSSEL

REF.	ACCESSORIES / ZUBEHÖR
BXX	Collets double slot DIN 6388 - Form B / Spannzangen mit Doppelnut DIN 6388 - Form B



BXX

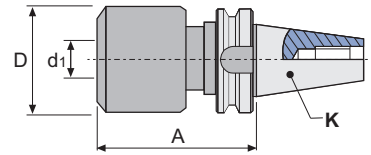

For more information see page / Für weitere Informationen siehe Seite: K.10



REF.	K ISO	A mm	d <sub>1</sub> mm	D mm	Ⓚ Kg
20.400.40.20	40	105	20	54	1,950
20.400.40.32		105	32	72	2,550
20.400.50.20	50	105	20	54	-
20.400.50.32		105	32	72	4,450

**COMPLEMENTS (Collets type C) / ZUBEHÖR (Spannzangen typ C)**

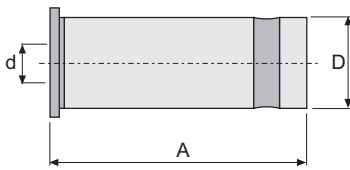
REF.	d mm	D mm	A mm
C2006	6	20	55
C2008	8	20	55
C2010	10	20	55
C2012	12	20	55
C2016	16	20	55
C3206	6	32	65
C3208	8	32	65
C3210	10	32	65
C3212	12	32	65
C3216	16	32	65
C3220	20	32	65
C3225	25	32	65



SET-C20  
SET-C32

REF.	DIN	Composition / Zusammenstellung	 Kg
SET-20.40.C20	BT	1 20.400.40.20 + 5 collets / spannzangen C20: Ø6, 8, 10, 12, 16	4,500
SET-20.40.C32		1 20.400.40.32 + 7 collets / spannzangen C32: Ø6, 8, 10, 12, 16, 20, 25	6,800
SET-20.50.C32		1 20.400.50.32 + 7 collets / spannzangen C32: Ø6, 8, 10, 12, 16, 20, 25	9,300

20 23  
JIS B 6339-BT

25  
CHIRON

BORING HEADS  
BOHRKÖPFE





MORSE SHANKS  
MORSE SCHÄFTE

CYLINDRICAL SHANKS  
ZYLINDRISCHE SCHÄFTE

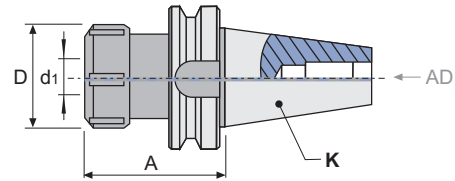
ACCESSORIES  
ZUBEHÖR





REF.	K ISO		A mm	d1 mm	D mm					
20.453.30.16	30	ER16	55	0,5-10	32	45316	50216	19210	0,490	
20.453.30.20		ER20	55	1-13	35	45320	50220	19212	0,490	
20.453.30.25		ER25	55	1-16	42	45325	50225	19216	0,520	
20.453.30.32		ER32	60	2-20	50	45332	50232	19218	0,580	
20.453.40.16	40	ER16	70	0,5-10	32	45316	50216	19210	1,130	
20.453.40.16/100		ER16	100	0,5-10	32	45316	50216	19210	1,230	
20.453.40.16/150		ER16	150	0,5-10	32	45316	50216	19210	1,400	
20.453.40.20		ER20	70	1-13	35	45320	50220	19212	1,120	
20.453.40.20/100		ER20	100	1-13	35	45320	50220	19212	1,320	
20.453.40.20/150		ER20	150	1-13	35	45320	50220	19212	1,550	
20.453.40.25		ER25	70	1-16	42	45325	50225	19216	1,200	
20.453.40.25/100		ER25	100	1-16	42	45325	50225	19216	-	
20.453.40.25/150		ER25	150	1-16	42	45325	50225	19216	1,790	
20.453.40.32		ER32	70	2-20	50	45332	50232	19222	1,230	
20.453.40.32/100		ER32	100	2-20	50	45332	50232	19222	-	
20.453.40.32/150		ER32	150	2-20	50	45332	50232	19222	2,180	
20.453.40.40		ER40	70	3-30	63	45340	50240	19224	1,340	
20.453.40.40/150		ER40	150	3-30	63	45340	50240	19224	2,280	
20.453.50.16/100		50	ER16	100	0,5-10	32	45316	50216	19210	3,840
20.453.50.16/150			ER16	150	0,5-10	32	45316	50216	19210	4,080
20.453.50.20/100	ER20		100	1-13	35	45320	50220	19212	3,950	
20.453.50.20/150	ER20		150	1-13	35	45320	50220	19212	4,060	
20.453.50.25	ER25		70	1-16	42	45325	50225	19216	3,830	
20.453.50.25/150	ER25		150	1-16	42	45325	50225	19216	4,360	
20.453.50.32	ER32		70	2-20	50	45332	50232	19222	3,850	
20.453.50.32/100	ER32		100	2-20	50	45332	50232	19222	-	
20.453.50.32/150	ER32		150	2-20	50	45332	50232	19222	4,530	
20.453.50.40	ER40		80	3-30	63	45340	50240	19224	4,060	
20.453.50.40/150	ER40		150	3-30	63	45340	50240	19224	5,240	
20.453.50.50	ER50		90	10-34	78	45350	50250	19230	4,290	

\* If you want with ball bearing nut, see page: K.22

\* SUPPLIED WITHOUT WRENCH / \* GELIEFERT OHNE SCHLÜSSEL

\* Wenn Sie diese mit Kugellager-Nute möchten, siehe Seite: K.22

REF.	ACCESSORIES / ZUBEHÖR
ERXX	Collets double slot DIN 6499 - Form B (ER) / Spannanzgen mit Doppelnut DIN 6499 - Form B (ER)
ERCXX	Sealed collets DIN 6499 (ER) / Abgedichtete Spannanzgen DIN 6499 (ER)
ERTXX	Collets DIN 6499 - Form Canela (ER) / Spannanzgen DIN 6499 - Form Canela (ER)
40.453..	Collet chucks for DIN 6499 (ER) collets / Spannanzgenfutter für DIN 6499 (ER) Spannanzgen
40.455..	Long collet chucks for DIN 6499 (ER) collets / Lange Spannanzgenfutter für DIN 6499 (ER) Spannanzgen



ERXX



ERCXX



ERTXX





40.453..



40.455..

For more information see page / Für weitere Informationen siehe Seite: K.13, K.17, K.19, J.08, J.09



REF.		K ISO		n° 	
SET-20.40.32	JIS B 6339-BT	40	ER32	18 (3-20)	-
SET-20.40.40	JIS B 6339-BT	40	ER40	23 (4-26)	-
SET-20.50.32	JIS B 6339-BT	50	ER32	18 (3-20)	-
SET-20.50.40	JIS B 6339-BT	50	ER40	23 (4-26)	-

20 23  
JIS B 6339-BT

25  
CHIRON





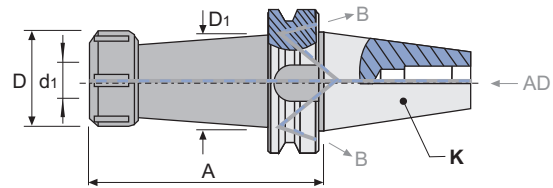

BORING HEADS  
BOHRKÖPFE

MORSE SHANKS  
MORSE SCHÄFTE

CYLINDRICAL SHANKS  
ZYLINDRISCHE SCHÄFTE

ACCESSORIES  
ZUBEHÖR

SIMILAR / ÄHNLICH WIE  
DIN 69871 - Form AD+B

REF.	K ISO		A mm	d1 mm	D mm	D1 mm					
23.453.40.16	40	ER16	70	0,5-10	32	-	45316	50216	19210	1,140	
23.453.40.16/100		ER16	100	0,5-10	32	28	45316	50216	19210	-	
23.453.40.16/150		ER16	150	0,5-10	32	28	45316	50216	19210	1,390	
23.453.40.20		ER20	70	1-13	35	-	45320	50220	19212	1,140	
23.453.40.20/100		ER20	100	1-13	35	34	45320	50220	19212	-	
23.453.40.20/150		ER20	150	1-13	35	34	45320	50220	19212	1,520	
23.453.40.25		ER25	70	1-16	42	-	45325	50225	19216	1,200	
23.453.40.25/150		ER25	150	1-16	42	42	45325	50225	19216	1,850	
23.453.40.32		ER32	70	2-20	50	-	45332	50232	19222	1,230	
23.453.40.32/150		ER32	150	2-20	50	50	45332	50232	19222	2,100	
23.453.40.40	ER40	70	3-30	63	-	45340	50240	19224	1,340		
23.453.40.40/150	ER40	150	3-30	63	63	45340	50240	19224	2,430		
23.453.50.16/100	50	ER16	100	0,5-10	32	28	45316	50216	19210	3,870	
23.453.50.16/150		ER16	150	0,5-10	32	28	45316	50216	19210	-	
23.453.50.20/100		ER20	100	1-13	35	28	45320	50220	19212	3,910	
23.453.50.20/150		ER20	150	1-13	35	28	45320	50220	19212	-	
23.453.50.25		ER25	70	1-16	42	-	45325	50225	19216	3,810	
23.453.50.25/150		ER25	150	1-16	42	42	45325	50225	19216	4,320	
23.453.50.32		ER32	70	2-20	50	-	45332	50232	19222	3,810	
23.453.50.32/100		ER32	100	2-20	50	50	45332	50232	19222	-	
23.453.50.32/150		ER32	150	2-20	50	50	45332	50232	19222	5,190	
23.453.50.40		ER40	80	3-30	63	-	45340	50240	19224	3,950	
23.453.50.40/150	ER40	150	3-30	63	63	45340	50240	19224	5,180		
23.453.50.50	ER50	90	10-34	78	-	45350	50250	19230	4,230		

\* If you want with ball bearing nut, see page: K.22  
\* Wenn Sie diese mit Kugellager-Nute möchten, siehe Seite: K.22

\* SUPPLIED WITHOUT WRENCH / \* GELIEFERT OHNE SCHLÜSSEL

REF.	ACCESSORIES / ZUBEHÖR
ERXX	Collets double slot DIN 6499 - Form B (ER) / Spannanzgen mit Doppelnut DIN 6499 - Form B (ER)
ERCXX	Sealed collets DIN 6499 (ER) / Abgedichtete Spannanzgen DIN 6499 (ER)
ERTXX	Collets DIN 6499 - Form Canela (ER) / Spannanzgen DIN 6499 - Form Canela (ER)
40.453..	Collet chucks for DIN 6499 (ER) collets / Spannanzgenfutter für DIN 6499 (ER) Spannanzgen
40.455..	Long collet chucks for DIN 6499 (ER) collets / Lange Spannanzgenfutter für DIN 6499 (ER) Spannanzgen



ERXX



ERCXX



ERTXX









40.453..

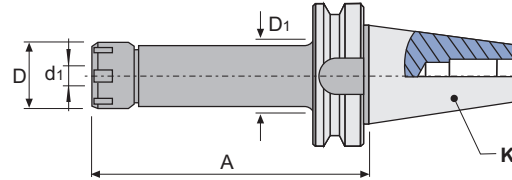

40.455..

For more information see page / Für weitere Informationen siehe Seite: K.13, K.17, K.19, J.08, J.09



REF.	K ISO		A mm	d <sub>1</sub> mm	D mm	D <sub>1</sub> mm				
20.455.40.16/100	40	ER16	100	0,5-10	22	22	45516	50916	19210	-
20.455.40.16/130		ER16	130	0,5-10	22	22	45516	50916	19210	-
20.455.40.16/160		ER16	160	0,5-10	22	22	45516	50916	19210	-
20.455.40.16/200		ER16	200	0,5-10	22	22	45516	50916	19210	-
20.455.40.20/100		ER20	100	1-13	28	28	45520	50920	19212	-
20.455.40.20/160		ER20	160	1-13	28	28	45520	50920	19212	-
20.455.40.25/100		ER25	100	1-16	35	35	45525	50925	19216	-
20.455.40.25/160		ER25	160	1-16	35	35	45525	50925	19216	-

\* SUPPLIED WITHOUT WRENCH / \* GELIEFERT OHNE SCHLÜSSEL

REF.	ACCESSORIES / ZUBEHÖR
ERXX	Collets double slot DIN 6499 - Form B (ER) / Spannzangen mit Doppelnut DIN 6499 - Form B (ER)
ERCXX	Sealed collets DIN 6499 (ER) / Abgedichtete Spannzangen DIN 6499 (ER)
ERTXX	Collets DIN 6499 - Form Canela (ER) / Spannzangen DIN 6499 - Form Canela (ER)



ERXX









ERCXX

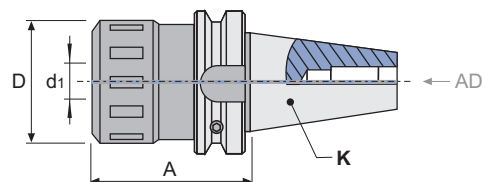

ERTXX

For more information see page / Für weitere Informationen siehe Seite: K.13, K.17, K.19



REF.	K ISO		A mm	d <sub>1</sub> mm	D mm				
20.457.40.32	40	ER32	80	2-20	54	45732	19006	50704	1,420
20.457.50.32	50	ER32	110	2-20	54	45732	19006	50704	4,610
20.457.50.40		ER40	120	3-30	65	45740	19010	50706	5,500

The alternative to hydraulic or other systems.  
High tightening and precision.  
Central coolant supply.

Die Alternative zu hydraulischen und anderen Systemen.  
Hohes Anzugsmoment und hohe Genauigkeit.  
Kühlmittel durch die Mitte.

\* SUPPLIED WITH WRENCH / \* GELIEFERT MIT SCHLÜSSEL

REF.	ACCESSORIES / ZUBEHÖR
ERXX	Collets double slot DIN 6499 - Form B (ER) / Spannzangen mit Doppelnut DIN 6499 - Form B (ER)
ERCXX	Sealed collets DIN 6499 (ER) / Abgedichtete Spannzangen DIN 6499 (ER)









ERXX

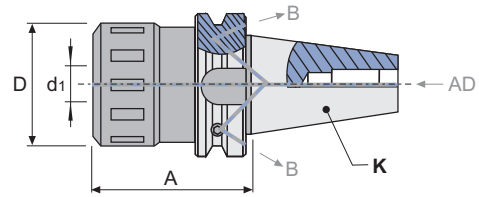

ERCXX

For more information see page / Für weitere Informationen siehe Seite: K.13, K.17



REF.	K ISO		A mm	d <sub>1</sub> mm	D mm				
23.457.40.32	40	ER32	80	2-20	54	45732	19006	50704	1,750
23.457.50.32	50	ER32	110	2-20	54	45732	19006	50704	4,380
23.457.50.40		ER40	120	3-30	65	45740	19010	50706	5,470

The alternative to hydraulic or other systems.  
High tightening and precision.  
Central coolant supply.

Die Alternative zu hydraulischen und anderen Systemen.  
Hohes Anzugsmoment und hohe Genauigkeit.  
Kühlmittel durch die Mitte.

\* SUPPLIED WITH WRENCH / \* GELIEFERT MIT SCHLÜSSEL

REF.	ACCESSORIES / ZUBEHÖR
ERXX	Collets double slot DIN 6499 - Form B (ER) / Spannzangen mit Doppelnut DIN 6499 - Form B (ER)
ERCXX	Sealed collets DIN 6499 (ER) / Abgedichtete Spannzangen DIN 6499 (ER)



ERXX



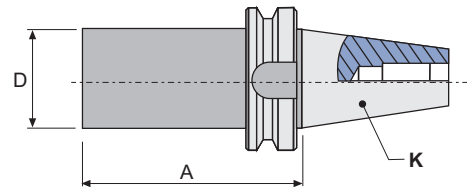

ERCXX

For more information see page / Für weitere Informationen siehe Seite: K.13, K.17

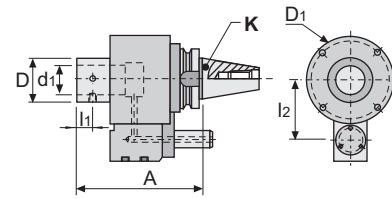

REF.	K ISO	D mm	A mm	Ⓚ kg
20.470.30.40	30	40,5	160	2,170
20.470.40.40	40	40,5	100	1,770
20.470.40.40/160		40,5	160	-
20.470.40.50		50,5	100	2,220
20.470.40.50/200		50,5	200	3,770
20.470.40.63		63,5	160	4,370
20.470.40.63/250		63,5	250	6,570
20.470.50.40	50	40,5	100	4,490
20.470.50.40/160		40,5	160	5,000
20.470.50.50		50,5	100	4,700
20.470.50.50/200		50,5	200	-
20.470.50.63		63,5	200	7,840
20.470.50.63/315		63,5	315	10,730
20.470.50.95		95,5	200	12,950
20.470.50.95/315		95,5	315	19,000



REF.	K ISO	d <sub>1</sub> G6 mm	A mm	D mm	D <sub>1</sub> mm	l <sub>1</sub> mm	l <sub>2</sub> * mm		
20.512.40.25	40	25	152	45	95	15	65	14116	-
20.512.40.32		32	152	48	95	16	65	14116	-
20.512.50.32	50	32	152	48	110	16	80	14116	-
20.512.50.40		40	166	58	110	17	80	14116	8,140

**rpm<sub>max</sub> 4.000 min.<sup>-1</sup> ≈ 25 bar<sub>max</sub>**

\* Other sizes are manufactured under order.  
 \* Andere Größen werden auf Antrag hergestellt.

**COMPLEMENTS OF 512 GROUP / ZUBEHÖR VON GRUPPE 512**

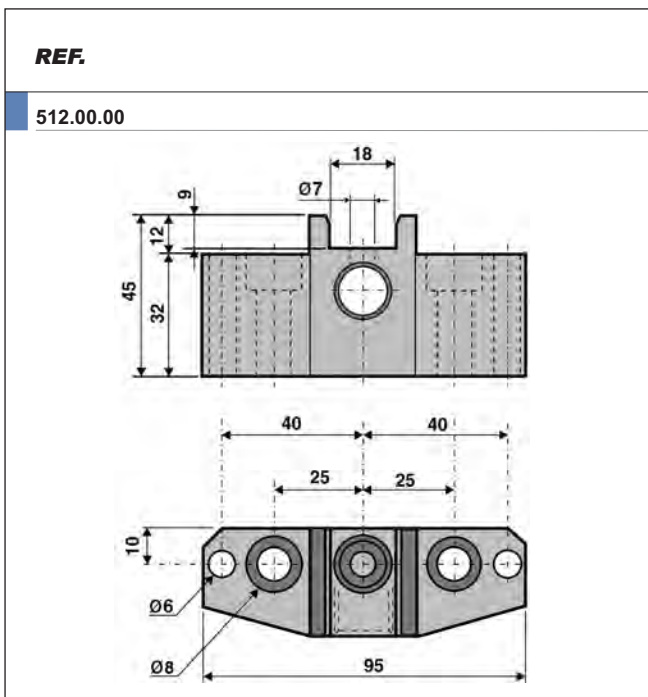



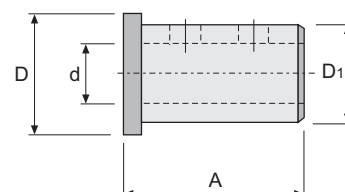

REF.	D mm	d mm	D <sub>1</sub> mm	A mm
512.25.16	25	16	33	60
512.25.20		20	33	60
512.32.16	32	16	40	60
512.32.20		20	40	60
512.32.25		25	40	60
512.40.16	40	16	48	60
512.40.20		20	48	60
512.40.25		25	48	60
512.40.32		32	48	60

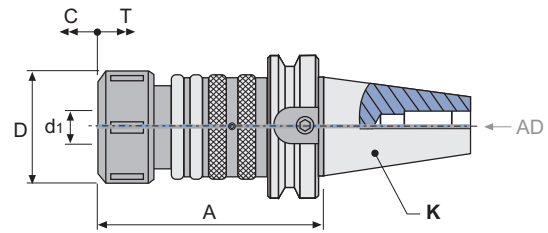





REF.	K ISO			d <sub>1</sub>	A mm	D mm	C mm	T mm			
20.610.30.16	30	ER16	M3-M12		99	28	5,5	6,0	45316	50216	0,580
20.610.40.16	40	ER16	M3-M12		100	28	5,5	6,0	45316	50216	1,560
20.610.40.25		ER25	M4-M20		125	42	10,5	7,5	45325	50225	-
20.610.40.40		ER40	M8-M33		141	63	10,0	10,0	45340	50240	-
20.610.50.16	50	ER16	M3-M12		100	28	5,5	6,0	45316	50216	4,230
20.610.50.25		ER25	M4-M20		134	42	10,5	7,5	45325	50225	-
20.610.50.40		ER40	M8-M33		150	63	10,0	10,0	45340	50240	-

Compensation in compression (C) and tension (T).  
Compression can be blocked by turning the rear ring (A).  
Control of threading depth.  
Central coolant supply.

Ausgleich der Kompression (C) und der Traktion (T).  
Die Kompression kann mit dem Ring (A) blockiert werden.  
Kontrolle der Gewindetiefe.  
Kühlmittel durch die Mitte.

\* SUPPLIED WITH WRENCH / \* GELIEFERT MIT SCHLÜSSEL

REF.	ACCESSORIES / ZUBEHÖR
ERXX	Collets double slot DIN 6499 - Form B (ER) / Spannzangen mit Doppelnut DIN 6499 - Form B (ER)
ERCXX	Sealed collets DIN 6499 (ER) / Abgedichtete Spannzangen DIN 6499 (ER)
ERTXX	Collets DIN 6499 - Form Canela (ER) / Spannzangen DIN 6499 - Form Canela (ER)
40.453..	Collet chucks for DIN 6499 (ER) collets / Spannzangenfutter für DIN 6499 (ER) Spannzangen
40.455..	Long collet chucks for DIN 6499 (ER) collets / Lange Spannzangenfutter für DIN 6499 (ER) Spannzangen



ERXX



ERCXX



ERTXX







40.453..

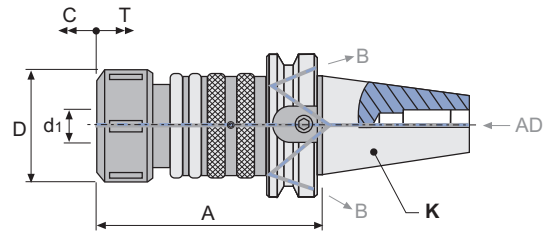

40.455..

For more information see page / Für weitere Informationen siehe Seite: K.13, K.17, K.19, J.08, J.09



REF.	K ISO			d <sub>1</sub>	A mm	D mm	C mm	T mm		
23.610.40.16	40	ER16	M3-M12	100	28	5,5	6,0	45316	50216	-
23.610.40.25		ER25	M4-M20	125	42	10,5	7,5	45325	50225	-
23.610.40.40		ER40	M8-M33	141	63	10,0	10,0	45340	50240	-
23.610.50.16	50	ER16	M3-M12	100	28	5,5	6,0	45316	50216	-
23.610.50.25		ER25	M4-M20	134	42	10,5	7,5	45325	50225	-
23.610.50.40		ER40	M8-M33	150	63	10,0	10,0	45340	50240	-

Compensation in compression (C) and tension (T).  
 Compression can be blocked by turning the rear ring (A).  
 Control of threading depth.  
 Central coolant supply.

Ausgleich der Kompression (C) und der Traktion (T).  
 Die Kompression kann mit dem Ring (A) blockiert werden.  
 Kontrolle der Gewindetiefe.  
 Kühlmittel durch die Mitte.

**\* SUPPLIED WITH WRENCH / \* GELIEFERT MIT SCHLÜSSEL**

REF.	ACCESSORIES / ZUBEHÖR
ERXX	Collets double slot DIN 6499 - Form B (ER) / Spannzangen mit Doppelnut DIN 6499 - Form B (ER)
ERCXX	Sealed collets DIN 6499 (ER) / Abgedichtete Spannzangen DIN 6499 (ER)
ERTXX	Collets DIN 6499 - Form Canela (ER) / Spannzangen DIN 6499 - Form Canela (ER)
40.453..	Collet chucks for DIN 6499 (ER) collets / Spannzangenfutter für DIN 6499 (ER) Spannzangen
40.455..	Long collet chucks for DIN 6499 (ER) collets / Lange Spannzangenfutter für DIN 6499 (ER) Spannzangen



ERXX



ERCXX



ERTXX







40.453..

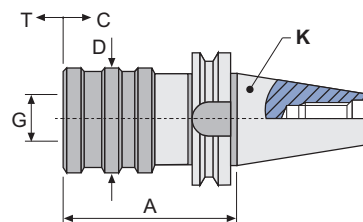

40.455..

For more information see page / Für weitere Informationen siehe Seite: K.13, K.17, K.19, J.08, J.09



REF.	K ISO	G No. Ø		A mm	D mm	C mm	T mm			
20.620.30.12	30	1 19	M3-M12	63	38	9	9	710XX	750XX	-
20.620.40.12	40	1 19	M3-M12	68	38	9	9	710XX	750XX	1,220
20.620.40.20		2 31	M8-M20	93	55	15	15	720XX	760XX	1,700
20.620.40.33		3 48	M14-M33	138	79	24	24	730XX	770XX	3,710
20.620.50.12	50	1 19	M3-M12	80	38	9	9	710XX	750XX	3,940
20.620.50.20		2 31	M8-M20	102	55	15	15	720XX	760XX	4,420
20.620.50.33		3 48	M14-M33	135	79	24	24	730XX	770XX	5,630

COMPENSATION IN COMPRESSION (C) AND TENSION (T)  
AUSGLEICH DER KOMPRESSIION (C) UND DER TRAKTION (T)

REF.	ACCESSORIES / ZUBEHÖR
710XX..730XX	Quick change adpaters without overload clutch / Schnellwechseleinsätze ohne Sicherheitskupplung
750XX..770XX	Quick change adpaters with overload clutch / Schnellwechseleinsätze mit Sicherheitskupplung







710XX..730XX

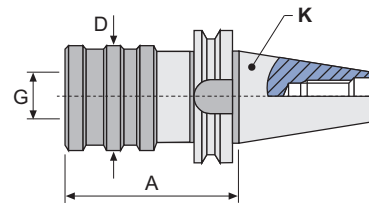

750XX..770XX

For more information see page / Für weitere Informationen siehe Seite: K.06, K.07



REF.	K ISO	G No. Ø		A mm	D mm			
20.630.30.12	30	1 19	M3-M12	60	33	710XX	750XX	-
20.630.40.12	40	1 19	M3-M12	67	33	710XX	750XX	1,170
20.630.40.20		2 31	M8-M20	90	50	720XX	760XX	1,620
20.630.40.33		3 48	M14-M33	117	72	730XX	770XX	-
20.630.50.12	50	1 19	M3-M12	78	33	710XX	750XX	-
20.630.50.20		2 31	M8-M20	101	50	720XX	760XX	-
20.630.50.33		3 48	M14-M33	125	72	730XX	770XX	-

WITH INNER COOLANT  
MIT INNENKÜHLUNG

REF.	ACCESSORIES / ZUBEHÖR
710XX..730XX	Quick change adapters without overload clutch / Schnellwechseleinsätze ohne Sicherheitskupplung
750XX..770XX	Quick change adapters with overload clutch / Schnellwechseleinsätze mit Sicherheitskupplung





710XX..730XX

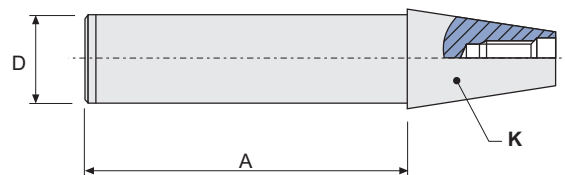

750XX..770XX

For more information see page / Für weitere Informationen siehe Seite: K.06, K.07



REF.	K ISO	A	D	
20.999.30	30	300	32	-
20.999.40	40	300	40	-
20.999.50	50	300	50	-

**1 TYPE / TYP**

20.160	20.165	20.180	20.210	20.215	20.216	20.225	20.226	20.290
20.295	20.296	20.300	20.302	20.305	20.353	20.400	20.453	20.455
20.457	20.470	20.512	20.610	20.620	20.630	A20.160	A20.160	A20.315
23.160	23.210	23.215	23.296	23.297	23.300	23.302	23.306	23.307
23.315	23.453	23.457	23.610					

**2 DIMENSION / ABMESSUNG**

<b>30</b>	<b>35</b>	<b>40</b>	<b>45</b>	<b>50</b>	<b>60</b>
-----------	-----------	-----------	-----------	-----------	-----------

**3 LENGTH (A) / LÄNGE (A)**



---

---

---

---

---

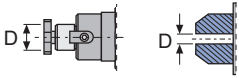
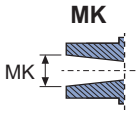
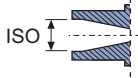
DIAMETER / DURCHMESSER	MK	ISO	COLLET SPANNZANGE
			

NOTES: \_\_\_\_\_

\_\_\_\_\_

\_\_\_\_\_

\_\_\_\_\_

\_\_\_\_\_

## MANUFACTURED FROM FORGED PARTS

## MATERIAL:

- Alloyed carburized steel at chrome-manganese 1.7131 (16MnCr5).

## EXECUTION:

- Carburized, hardness.  
- Surface hardness HRC 58±2 (670±40 HV30)  
- Depth minimum 0,5 mm.  
- Tensile strength in core minimum 800 N/mm<sup>2</sup> after carburizing.

## ACCURACY:

- Taper according to DIN 254  
- Taper angle:  
tolerance AT 3 DIN 7178 part 1 and DIN 2080 part 1.  
- Other tolerances according to DIN 7160 and 7168.  
- Taper surface roughness  $R_z < 0,001$  mm.

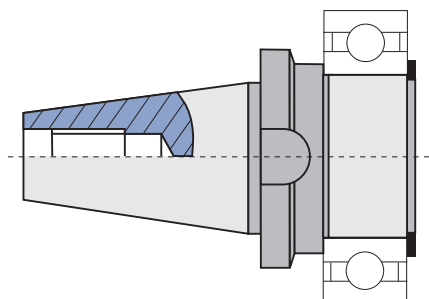

## HERGESTELLT AUS GESCHMIEDETEN TEILEN

## MATERIAL:

- Legierter Aufgekohlter Stahl mit Chrom-Mangan 1.7131 (16MnCr5).

## KONSTRUKTIONS DATEN:

- Aufgekohlt, gehärtet und angelassen.  
- Oberflächenhärte HRC 58±2 (670±40 HV30).  
- Aufgekohlt auf minimum 0,5 mm Tiefe.  
- Zugfestigkeit im Kern minimum 800 N/mm<sup>2</sup> nach der Aufkohlung.

## GENAUIGKEIT:

- Dorn nach DIN 254.  
- Kegelwinkel:  
Toleranz AT 3 DIN 7178 Teil 1 und DIN 2080 Teil 1.  
- Andere Toleranzen entsprechend DIN 7160 und 7168.  
- Rauigkeit der Oberfläche  $R_z < 0,001$  mm.

K	AT 3 mm
ISO 30	0,002
ISO 40	0,003
ISO 45	0,003
ISO 50	0,004
ISO 60	0,005

## TOLERANCE AT :

- Indicates the tolerance of size D surface between the real and the theoretical value of the taper conicity.  
- This value of surface D must always be less (negative), never more (positive) in order to GUARANTEE a good toolholder fixation at the bigger taper diameter.

## TOLERANZ AT :

- Zeigt die Toleranz auf der Messebene D zwischen dem tatsächlichen Wert der Kegelkonizität und dem theoretischen Wert.  
- Dieser Wert auf der Messebene D sollte immer minus (negativ) sein, nie plus (positiv), um für einen guten Halt des Futters in den größeren Durchmesser des Kegels zu garantieren.

25

CHIRON

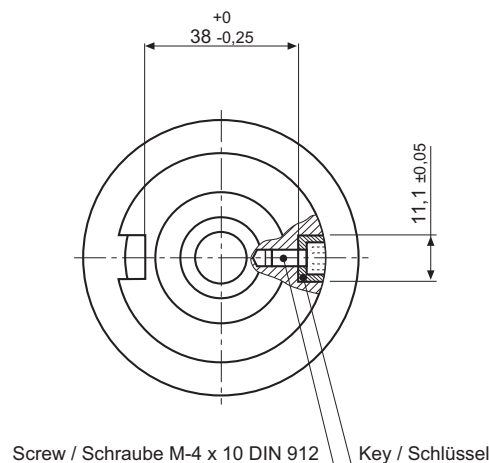
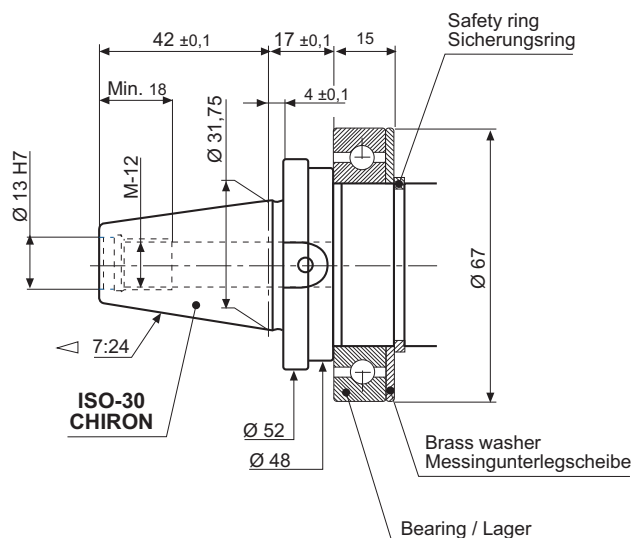





10  
DIN 208011 13  
DIN 69871-A16  
HSK DIN 69893-117  
TS ISO 26622-118  
PSC ISO 26623-120 23  
JIS B 6339-BT25  
CHIRON**CANELA****FRONTAL SHELL MILL ADAPTORS CHIRON**

for cutters with driving slot DIN 138

**STIRN-AUFSTECKFRÄSDORNE**

für Fräser mit Quernut DIN 138

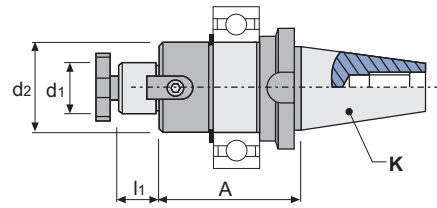



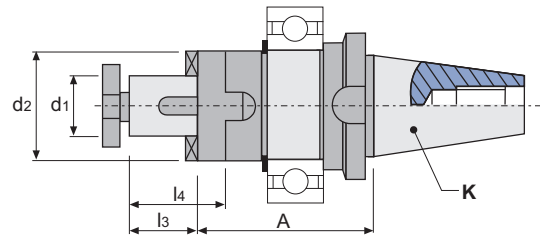

**CHIRON****25.160**

REF.	K ISO	Type / Typ	d <sub>1</sub> h6 mm	A mm	l <sub>1</sub> mm	d <sub>2</sub> mm	kg
25.160.30.16	30	A	16	50	17	39,8	0,800
25.160.30.22		A	22	50	19	39,8	-
25.160.30.27		B	27	50	21	48,0	0,900

REF.						
25.160.30.16	-	02526	32506	10008	11103	86016
25.160.30.22	-	02526	32506	10010	11004	86022
25.160.30.27	83025	02525	32506	10012	11005	86027



REF.	K ISO	d <sub>1</sub> h6 mm	A mm	l <sub>3</sub> mm	l <sub>4</sub> mm	d <sub>2</sub> mm	kg
25.180.30.16	30	16	57	17	27	39,8	0,760
25.180.30.22		22	61	19	31	39,8	-
25.180.30.27		27	62	21	33	48,0	0,770

REF.						
25.180.30.16	-	02526	32506	10008	60116	88016
25.180.30.22	-	02526	32506	10010	60122	88022
25.180.30.27	83025	02525	32506	10012	60127	88027

10  
DIN 208011 13  
DIN 69871-A16  
HSK DIN 69893-117  
TS ISO 26622-118  
PSC ISO 26623-120 23  
JIS B 6339-BT25  
CHIRON**CANELA****REDUCING ADAPTORS CHIRON**

for tools with Morse taper shank and drawbar thread DIN 228-A

**REDUZIERHÜLSEN CHIRON**

für Werkzeuge mit Morsekegel und Anzugsgewinde DIN 228-A

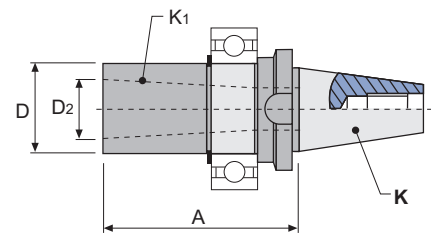
**CHIRON****25.210**

REF.	K ISO	K <sub>1</sub> MORSE	A mm	D mm	D <sub>2</sub> mm	kg
25.210.30.01	30	1	50	39,8	25	0,620
25.210.30.02		2	65	39,8	32	-
25.210.30.03		3	80	39,8	40	0,780

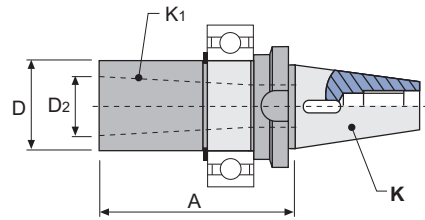

REF.				
25.210.30.01	16105	19312	32506	11106
25.210.30.02	16105	19315	32506	12110
25.210.30.03	16105	19318	32506	12012

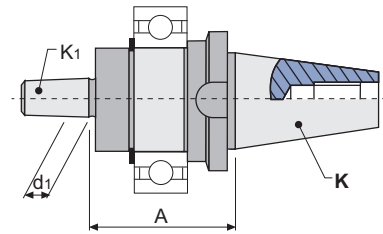

REF.	K ISO	K <sub>1</sub> MORSE	A mm	D mm	D <sub>2</sub> mm	⚖️ kg
25.215.30.01	30	1	50	39,8	25	0,600
25.215.30.02		2	62	39,8	32	-
25.215.30.03		3	80	39,8	40	0,740

REF.	⚙️
25.215.30.01	32506
25.215.30.02	32506
25.215.30.03	32506



REF.	K ISO	K <sub>1</sub> DIN	A mm	d <sub>1</sub> mm		
25.290.30.12	30	B-12	44	12,065	32506	0,630
25.290.30.16		B-16	44	15,733	32506	0,710

REF.	ACCESSORIES / ZUBEHÖR
MU	Standard keyless drill chucks DIN 238 / Standard Schnellspann-Bohrfutter DIN 238
MP	Precision keyless drill chucks DIN 238 / Schnellspann-Bohrfutter DIN 238, Genauigkeitsausführung
MK	Self clamping precision keyless drill chucks DIN 238 / Selbstspann-Bohrfutter DIN 238, Genauigkeitsausführung
MH	CNC-UNIVERSAL precision drill chucks DIN 238 / CNC-Universaler Bohrfutter DIN 238, Genauigkeitsausführung



MU



MP



MK



MH

For more information see page / Für weitere Informationen siehe Seite: K.02, K.03, K.04, K.05

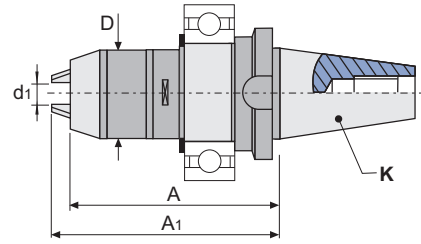

REF.	K ISO	d1 mm	D mm	A mm	A1 max mm	kg
25.295.30.08	30	0 - 8	35,5	83	91	0,880

\* SUPPLIED WITH WRENCH / \* GELIEFERT MIT SCHLÜSSEL

REF.				3 x 
25.295.30.08	11206	50008	32506	60308

25  
CHIRON

BORING HEADS  
BOHRKÖPFE

MORSE SHANKS  
MORSE SCHÄFTE

CYLINDRICAL SHANKS  
ZYLINDRISCHE SCHÄFTE

ACCESSORIES  
ZUBEHÖR



10  
DIN 208011 13  
DIN 69871-A16  
HSK DIN 69893-117  
TS ISO 26622-118  
PSC ISO 26623-120 23  
JIS B 6339-BT25  
CHIRON**CANELA****WELDON END MILL ADAPTORS CHIRON**

for cutters with cylindrical shank and weldon flat DIN 1835-B

**CHIRON ZYLINDERSCHAFT-AUFNAHME WELDON**

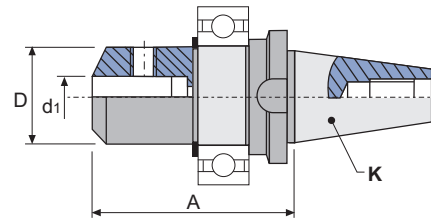
für Fräser mit zylindrischem Schaft und Weldon-Fläche DIN 1835-B

**CHIRON****25.300**

REF.	K ISO	d <sub>1</sub> H4 mm	A mm	D mm			 kg
25.300.30.06	30	6	70	25	32506	15106	0,680
25.300.30.08		8	70	28	32506	15108	-
25.300.30.10		10	70	35	32506	15110	-
25.300.30.12		12	70	40	32506	15212	0,830
25.300.30.14		14	70	40	32506	15212	-
25.300.30.16		16	70	40	32506	15314	0,810
25.300.30.18		18	70	40	32506	15314	0,780
25.300.30.20		20	70	40	32506	15216	0,790

REF.	ACCESSORIES / ZUBEHÖR
42.300	Short and long reducing bushings DIN 1835-B Form A and B / Kurze und lange Reduzierhülsen DIN 1835-B Form A und B
42.311	Short and long reducing bushings DIN 1835-B Form C / Kurze und lange Reduzierhülsen DIN 1835-B Form C







42.300

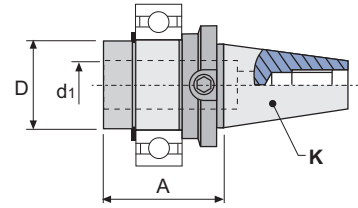

42.311

For more information see page / Für weitere Informationen siehe Seite: J.11, J.12



REF.	K ISO	d <sub>1</sub> H4 mm	A mm	D mm			
25.302.30.16	30	16	35	32	32506	15114	0,530
25.302.30.20		20	35	36	32506	15014	0,490

REF.	ACCESSORIES / ZUBEHÖR
42.610	Tapping head with axial compensation DIN 1835-B / Gewindefutter, mit Längenausgleich DIN 1835-B
42.620	Quick change tapping head with axial compensation DIN 1835-B+E / Gewindefutter-Schnellwechselfutter mit Längenausgleich DIN 1835-B + E



42.610



42.620

For more information see page / Für weitere Informationen siehe Seite: J.14, J.15



10  
DIN 208011 13  
DIN 69871-A16  
HSK DIN 69893-117  
TS ISO 26622-118  
PSC ISO 26623-120 23  
JIS B 6339-BT25  
CHIRON**CANELA****END MILL ADAPTORS TYPE WHISTLE-NOTCH CHIRON**



for tools with cylindrical shank and tightening inclined flat DIN 1835-E

**CHIRON ZYLINDERSCHAFT-AUFNAHME TYP WHISTLE-NOTCH**

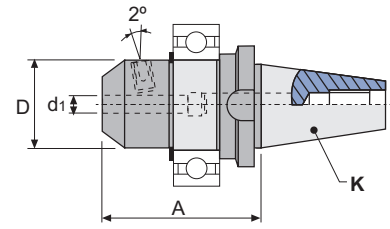
für Werkzeuge mit zylindrischem Schaft und geneigte Spannfläche DIN 1835-E

**CHIRON****25.305**

REF.	K ISO	d <sub>1</sub> H4 mm	A mm	D mm	kg
25.305.30.06	30	6	70	25	0,730
25.305.30.08		8	70	28	0,750
25.305.30.10		10	70	35	0,810
25.305.30.12		12	70	40	-
25.305.30.14		14	70	40	-
25.305.30.16		16	70	40	-
25.305.30.18		18	70	40	0,820

REF.			
25.305.30.06	32506	19005	15106
25.305.30.08	32506	19106	15108
25.305.30.10	32506	19008	15110
25.305.30.12	32506	19110	15212
25.305.30.14	32506	19110	15212
25.305.30.16	32506	19012	15314
25.305.30.18	32506	19012	15314

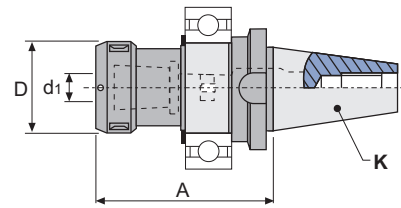

REF.	K ISO	A mm	d1 mm	D mm							
25.353.30.16	30	81	2-16	43	35316	-	-	32506	50116	19216	0,680
25.353.30.25		55	3-25	60	35325	02525	83025	32506	50125	19216	0,710

*\* If you want with ball bearing nut, see page: K.22*  
*\* Wenn Sie diese mit Kugellager-Nute möchten, siehe Seite: K.22*

**\* SUPPLIED WITHOUT WRENCH / \* GELIEFERT OHNE SCHLÜSSEL**







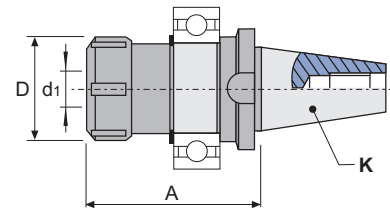

REF.	ACCESSORIES / ZUBEHÖR
BXX	Collets double slot DIN 6388 - Form B / Spannzangen mit Doppelnut DIN 6388 - Form B



**BXX**

*For more information see page / Für weitere Informationen siehe Seite: K.10*



REF.	K ISO		A mm	d <sub>1</sub> mm	D mm							
25.453.30.16	30	ER16	55	0,5-10	32	45316	-	-	32506	50216	19210	0,600
25.453.30.16/100		ER16	100	0,5-10	32	45316	-	-	32506	50216	19210	0,720
25.453.30.20		ER20	55	1-13	35	45320	-	-	32506	50220	19212	0,610
25.453.30.20/100		ER20	100	1-13	35	45320	-	-	32506	50220	19212	0,740
25.453.30.25		ER25	55	1-16	42	45325	-	-	32506	50225	19216	0,610
25.453.30.32		ER32	60	2-20	50	45332	-	-	32506	50232	19218	0,840
25.453.30.40		ER40	91	3-26	63	45340	02525	83025	32506	50240	19224	1,100

\* If you want with ball bearing nut, see page: K.22  
\* Wenn Sie diese mit Kugellager-Nute möchten, siehe Seite: K.22

\* SUPPLIED WITHOUT WRENCH / \* GELIEFERT OHNE SCHLÜSSEL

REF.	ACCESSORIES / ZUBEHÖR
ERXX	Collets double slot DIN 6499 - Form B (ER) / Spannzangen mit Doppelnut DIN 6499 - Form B (ER)
ERCXX	Sealed collets DIN 6499 (ER) / Abgedichtete Spannzangen DIN 6499 (ER)
ERTXX	Collets DIN 6499 - Form Canela (ER) / Spannzangen DIN 6499 - Form Canela (ER)
40.453..	Collet chucks for DIN 6499 (ER) collets / Spannzangenfutter für DIN 6499 (ER) Spannzangen
40.455..	Long collet chucks for DIN 6499 (ER) collets / Lange Spannzangenfutter für DIN 6499 (ER) Spannzangen



ERXX



ERCXX



ERTXX



40.453..



40.455..



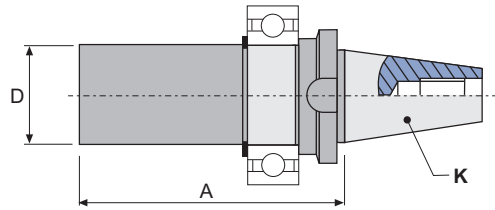



For more information see page / Für weitere Informationen siehe Seite: K.13, K.17, K.19, J.08, J.09

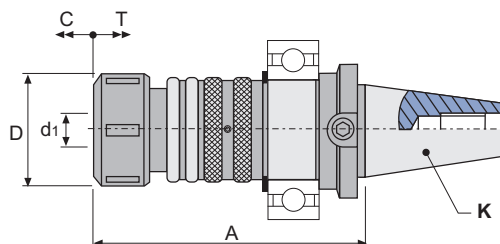

REF.	K ISO	D mm	A mm	kg
25.470.30.40	30	40	160	-
25.470.30.60		60	160	3,450

REF.				
25.470.30.40	02526	32506	-	-
25.470.30.60	02525	32506	83025	05525



REF.	K ISO		 d <sub>1</sub>	A mm	D mm	C mm	T mm				
25.610.30.16	30	ER16	M3-M12	100	28	7,5	6	45616	32506	50216	-

Compensation in compression (C) and tension (T).  
Compression can be blocked by turning the rear ring (A).  
Control of threading depth.  
Central coolant supply.

Ausgleich der Kompression (C) und der Traktion (T).  
Die Kompression kann mit dem Ring (A) blockiert werden.  
Kontrolle der Gewindetiefe.  
Kühlmittel durch die Mitte.

\* SUPPLIED WITH WRENCH / \* GELIEFERT MIT SCHLÜSSEL

REF.	ACCESSORIES / ZUBEHÖR
ERXX	Collets double slot DIN 6499 - Form B (ER) / Spannzangen mit Doppelnut DIN 6499 - Form B (ER)
ERCXX	Sealed collets DIN 6499 (ER) / Abgedichtete Spannzangen DIN 6499 (ER)
ERTXX	Collets DIN 6499 - Form Canela (ER) / Spannzangen DIN 6499 - Form Canela (ER)
40.453..	Collet chucks for DIN 6499 (ER) collets / Spannzangenfutter für DIN 6499 (ER) Spannzangen
40.455..	Long collet chucks for DIN 6499 (ER) collets / Lange Spannzangenfutter für DIN 6499 (ER) Spannzangen



ERXX



ERCXX



ERTXX



40.453..



40.455..

For more information see page / Für weitere Informationen siehe Seite: K.13, K.17, K.19, J.08, J.09

**1 TYPE / TYP**

25.160 	25.180 	25.210 	25.215 	25.290 
25.295 	25.300 	25.302 	25.305 	25.353 
25.453 	25.470 	25.610 		

**2 DIMENSION / ABMESSUNG**

30

**3 LENGTH (A) / LÄNGE (A)**





---

---

---

---

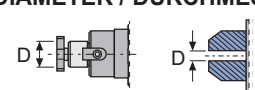
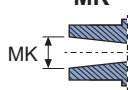
---

DIAMETER / DURCHMESSER	MK	ISO	COLLET SPANNZANGE
			

NOTES: \_\_\_\_\_

\_\_\_\_\_

\_\_\_\_\_

\_\_\_\_\_

\_\_\_\_\_

25 CHIRON  
 BORING HEADS  
 BOHRKÖPFE  
 MORSE SHANKS  
 MORSE SCHÄFTE  
 CYLINDRICAL SHANKS  
 ZYLINDRISCHE SCHÄFTE  
 ACCESSORIES  
 ZUBEHÖR

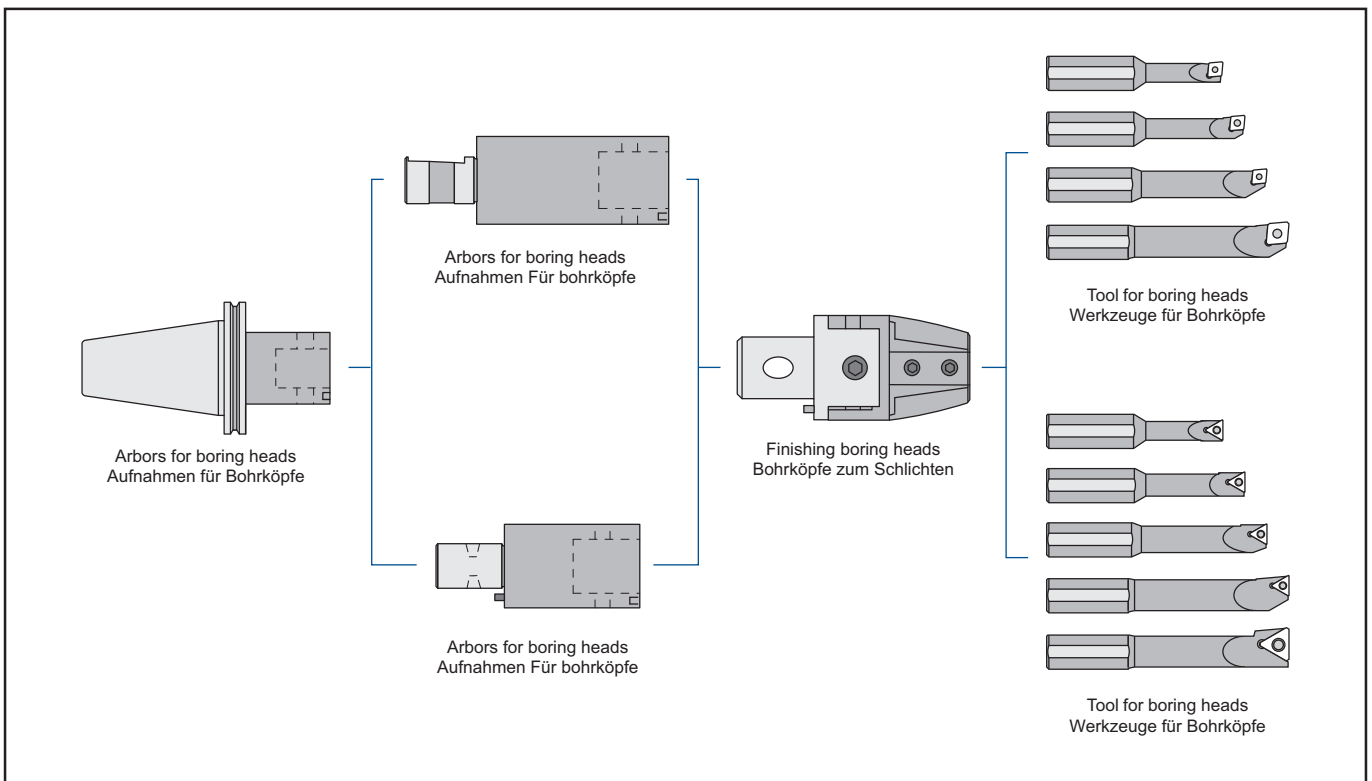
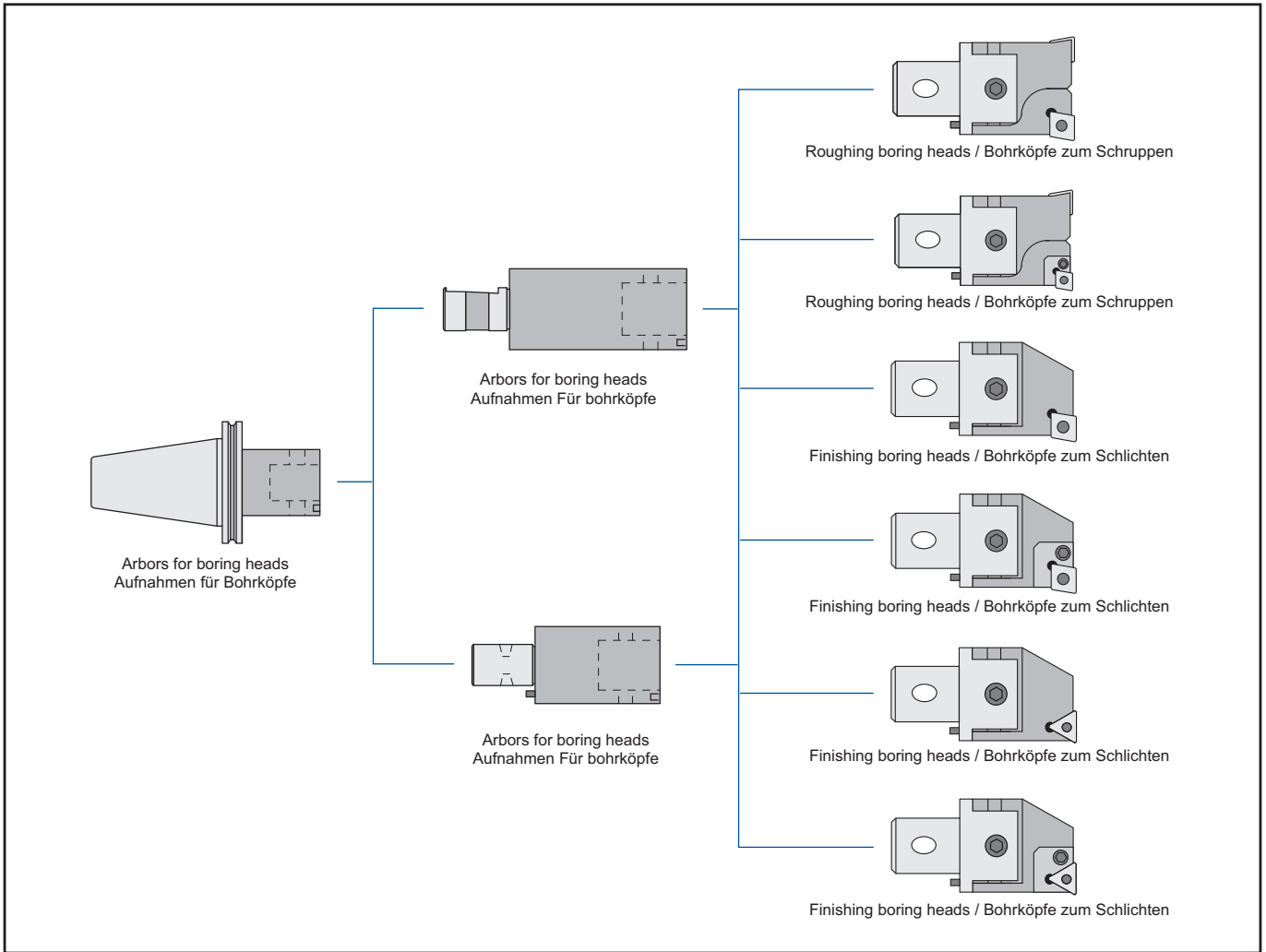

<p>97.15/24</p>  <p>H.02</p>	<p>SCLC</p>  <p>H.03</p>	<p>STFC</p>  <p>H.04</p>	<p>63.12/28</p>  <p>H.05</p>	<p>63.36/60</p>  <p>H.06</p>
<p>64.12/28</p>  <p>H.07</p>	<p>64.36/60</p>  <p>H.08</p>	<p>66.20/28</p>  <p>H.09</p>	<p>66.36/60</p>  <p>H.10</p>	<p>10.700</p>  <p>H.11</p>
<p>11.700</p>  <p>H.12</p>	<p>16.700</p>  <p>H.13</p>	<p>17.700</p>  <p>H.14</p>	<p>18.700</p>  <p>H.15</p>	<p>20.700</p>  <p>H.16</p>
<p>60.62/64</p>  <p>H.17</p>	<p>60.12/24</p>  <p>H.17</p>	<p>SET-97 SCLC</p>  <p>H.18</p>	<p>SET-97 STFC</p>  <p>H.18</p>	



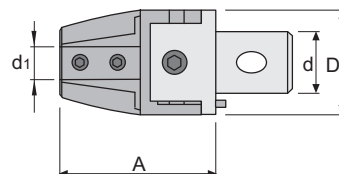



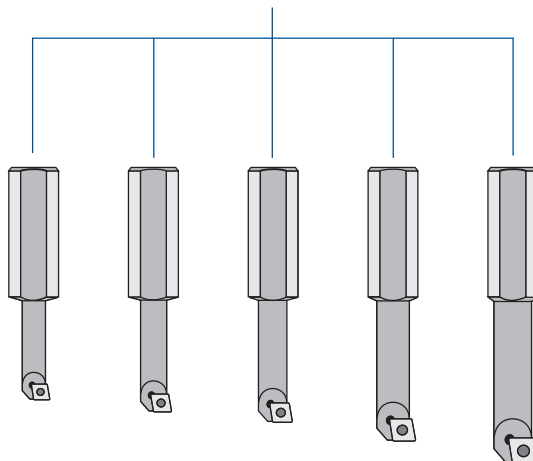
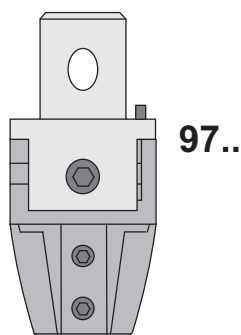

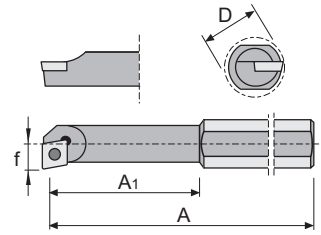
REF.	D mm	A mm	d mm	d <sub>1</sub> mm	D min	D max	kg
97.15.08	27	50	15	8	10	21	0,170
97.20.08	32	58	20	8	10	21	0,280
97.20.10	32	58	20	10	13	25	0,290
97.24.10	42	70	24	10	13	29	0,650
97.24.12	42	70	24	12	16	34	0,620
97.24.16	42	70	24	16	20	38	0,600

**SCLC/STFC**



REF.	D mm	A mm	A <sub>1</sub> mm	f mm	Bore range Bohrungsbereich		Insert Wendplatte	kg
					min	max		
S0816F SCLC R 06	16	80	35	4	10	28	CC.. 0602..	0,070
S1016G SCLC R 06	16	90	45	6	13	31	CC.. 0602..	0,100
S1216H SCLC R 06	16	100	57	7	16	34	CC.. 0602..	0,100
S1616I SCLC R 09	16	110	73	9	20	38	CC.. 09T3..	0,150

REF.		
S0816F SCLC R 06	10425	50507
S1016G SCLC R 06	10425	50507
S1216H SCLC R 06	10425	50507
S1616I SCLC R 09	10440	50515

REF.	CCGT-AL	CCMT-03	CCMW	l	s	d	Positive 7° clearance - 80° rhombic inserts. 80° Rhombische positive Wendschneidplatte mit 7° Freiwinkel.
CC.. 0602..				6,45	2,38	6,35	
CC.. 09T3..				9,65	3,97	9,52	
							

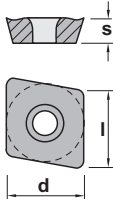

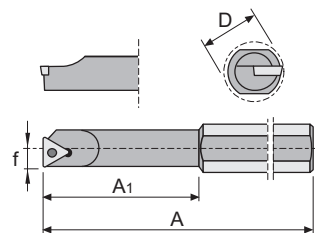

REF.	D mm	A mm	A <sub>1</sub> mm	f mm	Bore range Bohrungsbereich		Insert Wendplatte	kg
					min	max		
S0816F STFC R 09	16	80	35	5	10	28	TC.. 0902..	0,090
S1016G STFC R 09	16	90	45	6	13	31	TC.. 0902..	0,100
S1216H STFC R 09	16	100	57	7	16	34	TC.. 0902..	0,100
S1616I STFC R 09	16	110	73	9	20	38	TC.. 0902..	0,100
S1616I STFC R 16	16	110	73	11	20	38	TC.. 16T3..	0,150

REF.		
S0816F STFC R 09	10222	50506
S1016G STFC R 09	10222	50506
S1216H STFC R 09	10222	50506
S1616I STFC R 09	10222	50506
S1616I STFC R 16	10425	50515

	REF.	l	s	d	Positive 7° clearance - Triangular inserts. Dreieckige positive Wendeschneidplatte mit 7° Freiwinkel.
	TC.. 0902..	9,62	2,38	5,55	
TC.. 16T3..	16,50	3,97	9,52		
	TCGT-AL	TCMT-03	TCMT-39	TCMW	

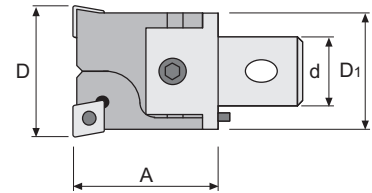

REF.	D <sub>1</sub> mm	A mm	d mm	D min	D max	Insert Wendeplatte	 kg
63.12.2430	22	34	12	24	30	CC.. 0602..	0,075
63.15.2940	27	42	15	29	40	CC.. 09T3..	0,150
63.20.3950	32	45	20	39	50	CC.. 09T3..	0,250
63.24.4965	42	56	24	49	65	CC.. 1204..	0,500
63.28.6382	54	56	28	63	82	CC.. 1204..	1,000

REF.				
63.12.2430	10425	50607	50003	50002
63.15.2940	10240	50615	50004	50002
63.20.3950	10240	50615	50004	50025
63.24.4965	10250	50620	50005	50003
63.28.6382	10250	50620	50006	50003

	REF.	l	s	d	Positive 7° clearance - 80° rhombic inserts. 80° Rhombische positive Wendschneidplatte mit 7° Freiwinkel.
	CC.. 0602..	6,45	2,38	6,35	
CC.. 09T3..	9,65	3,97	9,52		
	CCGT-AL	CCMT-03	CCMW		

10  
DIN 2080**CANELA**

ROUGHING BORING HEADS

BOHRKÖPFE ZUM SCHRUPPEN

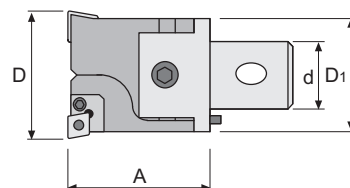
**63.36/60**11 13  
DIN 69871-A16  
HSK DIN 69893-117  
TS ISO 26622-118  
PSC ISO 26623-120 23  
JIS B 6339-BT25  
CHIRONBORING HEADS  
BOHRKÖPFE

REF.	D <sub>1</sub> mm	A mm	d mm	D min	D max	Insert Wendeplatte	Kg
63.36.080102	68	86	36	80	102	CC.. 1204..	2,200
63.50.100125	85	100	50	100	125	CC.. 1204..	4,000
63.60.125160	110	100	60	125	160	CC.. 1204..	6,550
63.60.160220	145	100	60	160	220	CC.. 1204..	8,700

REF.					
63.36.080102	10250	50620	50508	50004	60412
63.50.100125	10250	50620	50508	50005	60412
63.60.125160	10250	50620	50508	50005	60412
63.60.160220	10250	50620	50508	50005	60412

 	REF.	l	s	d	Positive 7° clearance - 80° rhombic inserts. 80° Rhombische positive Wendschneidplatte mit 7° Freiwinkel.
	CC.. 0602..	6,45	2,38	6,35	
CC.. 09T3..	9,65	3,97	9,52		
	<b>CCGT-AL</b>	<b>CCMT-03</b>	<b>CCMW</b>		

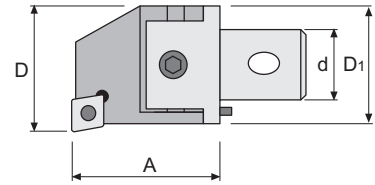

REF.	D <sub>1</sub> mm	A mm	d mm	D min	D max	Insert Wendepatte	kg
64.12.2430	22	34	12	24	30	CC.. 0602..	0,075
64.15.2940	27	42	15	29	40	CC.. 09T3..	0,150
64.20.3950	32	45	20	39	50	CC.. 09T3..	0,250
64.24.4965	42	56	24	49	65	CC.. 1204..	0,450
64.28.6382	54	56	28	63	82	CC.. 1204..	0,900

REF.				
64.12.2430	10425	50607	50003	50002
64.15.2940	10240	50615	50004	50002
64.20.3950	10240	50615	50004	50025
64.24.4965	10250	50620	50005	50003
64.28.6382	10250	50620	50006	50003

	REF.	l	s	d	Positive 7° clearance - 80° rhombic inserts. 80° Rhombische positive Wendeschneidplatte mit 7° Freiwinkel.
	CC.. 0602..	6,45	2,38	6,35	
CC.. 09T3..	9,65	3,97	9,52		
	CCGT-AL	CCMT-03	CCMW		

10  
DIN 2080**CANELA**

FINISHING BORING HEADS

BOHRKÖPFE ZUM SCHLICHTEN

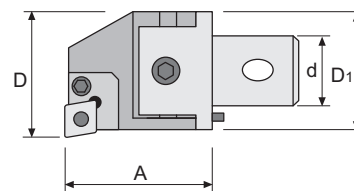
**64.36/60**11 13  
DIN 69871-A16  
HSK DIN 69893-117  
TS ISO 26622-118  
PSC ISO 26623-120 23  
JIS B 6339-BT25  
CHIRONBORING HEADS  
BOHRKÖPFE

REF.	D <sub>1</sub> mm	A mm	d mm	D min	D max	Insert Wendeplatte	Kg
64.36.080102	68	86	36	80	102	CC.. 1204..	2,050
64.50.100125	85	100	50	100	125	CC.. 1204..	3,700
64.60.125160	110	100	60	125	160	CC.. 1204..	6,150
64.60.160220	145	100	60	160	220	CC.. 1204..	8,050

REF.						
64.36.080102	10250	50620	50508	50004	50004	60412
64.50.100125	10250	50620	50508	50005	50005	60412
64.60.125160	10250	50620	50508	50005	50005	60412
64.60.160220	10250	50620	50508	50005	50005	60412

 	REF.	l	s	d	Positive 7° clearance - 80° rhombic inserts. 80° Rhombische positive Wendschneidplatte mit 7° Freiwinkel.
	CC.. 0602..	6,45	2,38	6,35	
CC.. 09T3..	9,65	3,97	9,52		
	<b>CCGT-AL</b>	<b>CCMT-03</b>	<b>CCMW</b>		

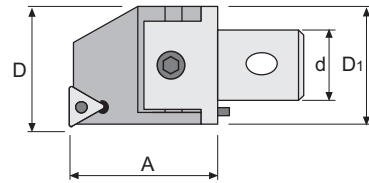

REF.	D <sub>1</sub> mm	A mm	d mm	D min	D max	Insert Wendeplatte	kg
66.20.3950	32	45	20	39	50	TC.. 16T3..	0,250
66.24.4965	42	56	24	49	65	TC.. 16T3..	0,450
66.28.6382	54	66	28	63	82	TC.. 16T3..	0,900

REF.				
66.20.3950	10240	50615	50004	50025
66.24.4965	10250	50620	50005	50003
66.28.6382	10250	50620	50006	50003

	REF.	l	s	d	Positive 7° clearance - Triangular inserts. Dreieckige positive Wendschneidplatte mit 7° Freiwinkel.
	TC.. 0902..	9,62	2,38	5,55	
TC.. 16T3..	16,50	3,97	9,52		
	TCGT-AL	TCMT-03	TCMT-39	TCMW	



10  
DIN 208011 13  
DIN 69871-A16  
HSK DIN 69893-117  
TS ISO 26622-118  
PSC ISO 26623-120 23  
JIS B 6339-BT25  
CHIRONBORING HEADS  
BOHRKÖPFE**CANELA**

FINISHING BORING HEADS

BOHRKÖPFE ZUM SCHLICHTEN

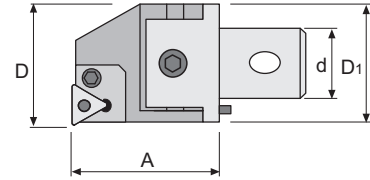
**66.36/60**

REF.	D <sub>1</sub> mm	A mm	d mm	D min	D max	Insert Wendeplatte	Kg
66.36.080102	68	86	36	80	102	TC.. 16T3..	2,050
66.50.100125	85	100	50	100	125	TC.. 16T3..	3,700
66.60.125160	110	100	60	125	160	TC.. 16T3..	6,150
66.60.160220	145	100	60	160	220	TC.. 16T3..	8,050

REF.					
66.36.080102	10250	50620	50508	50004	60416
66.50.100125	10250	50620	50508	50005	60416
66.60.125160	10250	50620	50508	50005	60416
66.60.160220	10250	50620	50508	50005	60416

	REF.	l	s	d	Positive 7° clearance - Triangular inserts. Dreieckige positive Wendschneidplatte mit 7° Freiwinkel.
	TC.. 0902..	9,62	2,38	5,55	
TC.. 16T3..	16,50	3,97	9,52		
	TCGT-AL	TCMT-03	TCMT-39	TCMW	

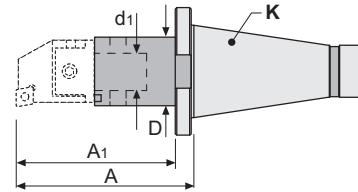

REF.	K ISO	D mm	A mm	A <sub>1</sub> mm	d <sub>1</sub> mm	Ⓚ kg
10.700.30.12/100	30	22	115	100	12	0,450
10.700.30.15/100		27	115	100	15	0,550
10.700.30.20/100		32	115	100	20	0,600
10.700.40.12/100	40	22	115	100	12	0,950
10.700.40.15/100		27	115	100	15	1,050
10.700.40.20/100		32	115	100	20	1,100
10.700.40.24/160		42	175	160	24	1,850
10.700.40.28/160		54	175	160	28	2,300
10.700.40.36/160		68	176	160	36	2,500
10.700.50.12/100	50	22	119	100	12	2,850
10.700.50.15/100		27	119	100	15	2,900
10.700.50.20/130		32	149	130	20	3,150
10.700.50.24/160		42	179	160	24	3,700
10.700.50.28/160		54	179	160	28	4,250
10.700.50.36/200		68	220	200	36	5,650
10.700.50.50/200		85	221	200	50	6,350
10.700.50.60/260		100	281	260	60	11,000

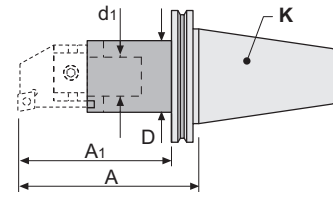

REF.	K ISO	D mm	A mm	A <sub>1</sub> mm	d <sub>1</sub> mm	⚖️ kg
11.700.40.12/100	40	22	115	100	12	1,200
11.700.40.15/100		27	115	100	15	1,250
11.700.40.20/100		32	115	100	20	1,500
11.700.40.24/160		42	175	160	24	1,900
11.700.40.28/160		54	175	160	28	2,300
11.700.40.36/160		68	176	160	36	2,600
11.700.50.12/100		50	22	119	100	12
11.700.50.15/100	27		119	100	15	3,400
11.700.50.20/130	32		149	130	20	3,600
11.700.50.24/160	42		179	160	24	4,200
11.700.50.28/160	54		179	160	28	4,700
11.700.50.36/200	68		220	200	36	5,650
11.700.50.50/200	85		221	200	50	6,200
11.700.50.60/260	100		281	260	60	10,850

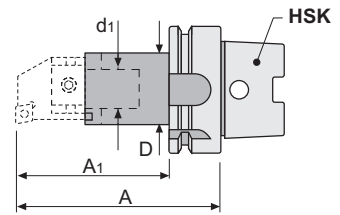

REF.	HSK	D mm	A mm	A <sub>1</sub> mm	d <sub>1</sub> mm	
16.700.63.12/055	63	22	81	55	12	
16.700.63.12/110		22	136	110	12	
16.700.63.15/065		27	91	65	15	
16.700.63.15/110		27	136	110	15	
16.700.63.20/075		32	101	75	20	
16.700.63.20/120		32	146	120	20	

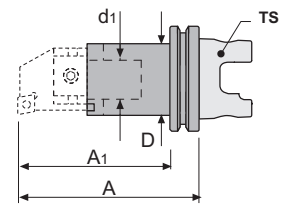

REF.	TS	D mm	A mm	A <sub>1</sub> mm	d <sub>1</sub> mm	
17.700.63.12/055	63	22	74	55	12	
17.700.63.12/110		22	129	110	12	
17.700.63.15/065		27	84	65	15	
17.700.63.15/110		27	129	110	15	
17.700.63.20/075		32	94	75	20	
17.700.63.20/120		32	139	120	20	

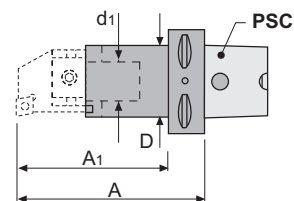

REF.	PSC	D mm	A mm	A <sub>1</sub> mm	d <sub>1</sub> mm	
18.700.63.12/055	63	22	77	55	12	
18.700.63.12/110		22	132	110	12	
18.700.63.15/065		27	87	65	15	
18.700.63.15/110		27	132	110	15	
18.700.63.20/075		32	97	75	20	
18.700.63.20/120		32	142	120	20	

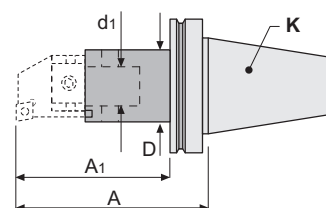

REF.	K ISO	D mm	A mm	A <sub>1</sub> mm	d <sub>1</sub> mm	kg
20.700.40.12/100	40	22	115	100	12	1,200
20.700.40.15/100		27	115	100	15	1,250
20.700.40.20/100		32	115	100	20	1,600
20.700.40.24/160		42	175	160	24	2,050
20.700.40.28/160		54	175	160	28	2,550
20.700.40.36/160		68	176	160	36	2,550
20.700.50.12/100	50	22	119	100	12	3,850
20.700.50.15/100		27	119	100	15	3,950
20.700.50.20/130		32	149	130	20	4,200
20.700.50.24/160		42	179	160	24	5,200
20.700.50.28/160		54	179	160	28	5,800
20.700.50.36/200		68	220	200	36	6,650
20.700.50.50/200		85	221	200	50	7,400
20.700.50.60/260		100	281	260	60	12,300

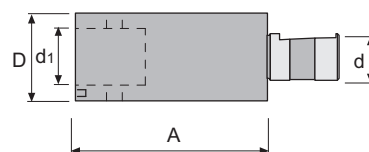

REF.	D mm	d mm	A mm	d1 mm	kg
60.62.12	22	20	20	12	0,050
60.62.15	27	20	30	15	0,100
60.63.12	22	20	30	12	0,120
60.63.15	27	20	45	15	0,230
60.63.20	32	25	35	20	0,320
60.64.12	22	20	52	12	0,210
60.64.15	27	20	52	15	0,290
60.64.20	32	20	52	20	0,400
60.64.24	42	25	60	24	0,500

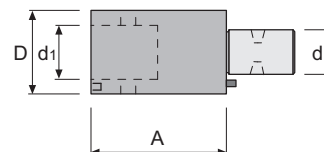

REF.	D mm	d mm	A mm	d1 mm	kg
60.12.12/20	22	12	20	12	0,050
60.12.12/30	22	12	30	12	0,100
60.15.15/30	27	15	30	15	0,130
60.15.15/45	27	15	45	15	0,190
60.20.20/35	32	20	35	20	0,200
60.20.20/52	32	20	52	20	0,270
60.24.24/40	42	24	40	24	0,400
60.24.24/60	42	24	60	24	0,600



10  
DIN 2080**CANELA**

SETS

SÄTZE

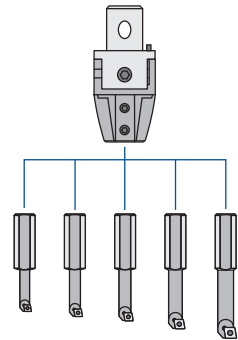
**SET-97**11 13  
DIN 69871-A16  
HSK DIN 69893-117  
TS ISO 26622-118  
PSC ISO 26623-120 23  
JIS B 6339-BT25  
CHIRONBORING HEADS  
BOHRKÖPFE

REF.	Boring head Bohrkopf	Boring bars Bohrstangen	Bore range Bohrungsbereich		Kg	
			min	max		
SET-97 SCLC	97.24.16	S0816F SCLC R 06	10	28	-	
		S1016G SCLC R 06	13	31	-	
		S1216H SCLC R 06	16	34	-	
		S1616I SCLC R 09	20	38	-	

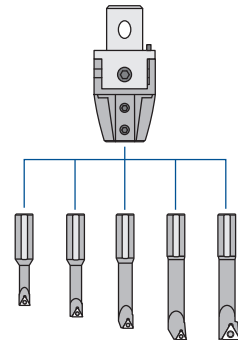

REF.	Boring head Bohrkopf	Boring bars Bohrstangen	Bore range Bohrungsbereich		Kg	
			min	max		
SET-97 STFC	97.24.16	S0816F STFC R09	10	28	-	
		S1016G STFC R 09	13	31	-	
		S1216H STFC R 09	16	34	-	
		S1216I STFC R 09	20	38	-	
		S1616I STFC R 16	20	38	-	

## 1 TYPE / TYP



## 2 DIMENSION / ABMESSUNG

ISO

<b>30</b>	<b>35</b>	<b>40</b>	<b>45</b>	<b>50</b>	<b>60</b>
-----------	-----------	-----------	-----------	-----------	-----------

HSK

<b>32</b>	<b>40</b>	<b>50</b>	<b>63</b>	<b>80</b>	<b>100</b>
-----------	-----------	-----------	-----------	-----------	------------

TS

<b>40</b>	<b>50</b>	<b>63</b>	<b>80</b>	<b>100</b>
-----------	-----------	-----------	-----------	------------

PSC

<b>32</b>	<b>40</b>	<b>50</b>	<b>63</b>	<b>80</b>	<b>100</b>
-----------	-----------	-----------	-----------	-----------	------------

## 3 LENGTH (A) / LÄNGE (A)

	<hr/> <hr/> <hr/> <hr/> <hr/> <hr/>
---	-------------------------------------

DIAMETER / DURCHMESSER	COLLET SPANNZANGE
	

NOTES: \_\_\_\_\_

\_\_\_\_\_

\_\_\_\_\_

\_\_\_\_\_

\_\_\_\_\_

## MANUFACTURED FROM FORGED PARTS

## MATERIAL:

- Alloyed carburized steel at chrome-manganese 1.7131 (16MnCr5).

## EXECUTION:

- Carburized, hardness.  
- Surface hardness HRC 58±2 (670±40 HV30)  
- Depth minimum 0,5 mm.  
- Tensile strength in core minimum 800 N/mm<sup>2</sup> after carburizing.

## ACCURACY:

- Taper according to DIN 254  
- Taper angle:  
tolerance AT 3 DIN 7178 part 1 and DIN 2080 part 1.  
- Other tolerances according to DIN 7160 and 7168.  
- Taper surface roughness  $R_z < 0,001$  mm.

## HERGESTELLT AUS GESCHMIEDETEN TEILEN

## MATERIAL:

- Legierter Aufgekohlter Stahl mit Chrom-Mangan 1.7131 (16MnCr5).

## KONSTRUKTIONS DATEN:

- Aufgekohlt, gehärtet und angelassen.  
- Oberflächenhärte HRC 58±2 (670±40 HV30).  
- Aufgekohlt auf minimum 0,5 mm Tiefe.  
- Zugfestigkeit im Kern minimum 800 N/mm<sup>2</sup> nach der Aufkohlung.

## GENAUIGKEIT:

- Dorn nach DIN 254.  
- Kegelwinkel:  
Toleranz AT 3 DIN 7178 Teil 1 und DIN 2080 Teil 1.  
- Andere Toleranzen entsprechend DIN 7160 und 7168.  
- Rauigkeit der Oberfläche  $R_z < 0,001$  mm.

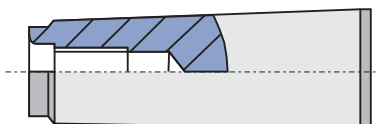

## TOLERANCE AT:

- Indicates the tolerance of size D surface between the real and the theoretical value of the taper conicity.  
- This value of surface D must always be less (negative), never more (positive) in order to GUARANTEE a good toolholder fixation at the bigger taper diameter.

## TOLERANZ AT:

- Zeigt die Toleranz auf der Messebene D zwischen dem tatsächlichen Wert der Kegelkonizität und dem theoretischen Wert.  
- Dieser Wert auf der Messebene D sollte immer minus (negativ) sein, nie plus (positiv), um für einen guten Halt des Futterers in den größeren Durchmesser des Kegels zu garantieren.

## DIN 228A/B

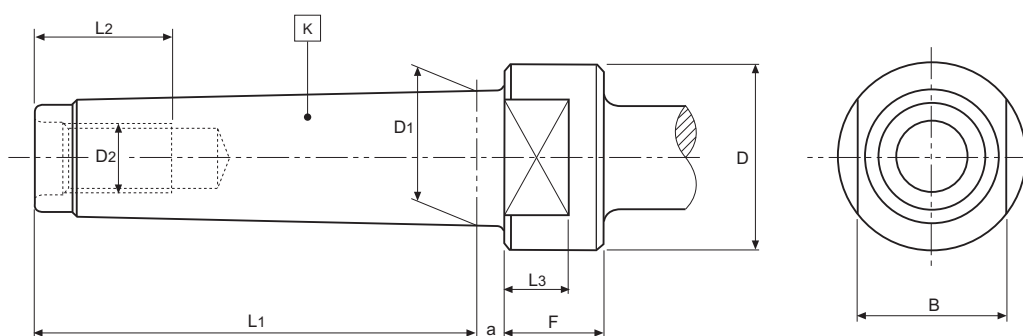

MORSE	L <sub>1</sub> mm	L <sub>2</sub> mm	L <sub>3</sub> mm	D mm	D <sub>1</sub> mm	D <sub>2</sub> mm	F min mm	B d9 mm	a mm
1	53,5	16	-	-	12,065	M-6	-	-	3,5
2	64,0	24	-	-	17,780	M-10	-	-	5,0
3	81,0	24	12	36	23,825	M-12	18	24	5,0
4	102,5	32	15	43	31,267	M-16	23	32	6,5
5	129,5	40	18	60	44,399	M-20	28	45	6,5
6	182,0	47	25	84	63,348	M-24	39	65	8,0







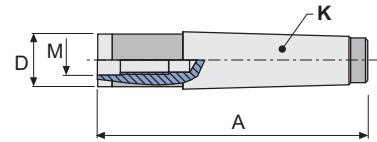

10  
DIN 208011 13  
DIN 69871-A16  
HSK DIN 69893-117  
TS ISO 26622-118  
PSC ISO 26623-120 23  
JIS B 6339-BT25  
CHIRONBORING HEADS  
BOHRKÖPFEMORSE SHANKS  
MORSE SCHÄPFTE**CANELA**

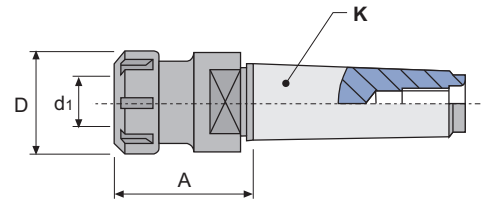
**MORSE MODULAR SHANKS**  
for modular milling heads  
**MORSE MODULAR-SCHÄPFTE**  
Für Modular-Fräsköpfe

**30.315**

REF.	K MORSE	A mm	M mm	D mm	kg
30.315.03.08	3	125	M8	14	0,290
30.315.03.10	3	125	M10	18	0,300
30.315.03.12	3	125	M12	21	0,305
30.315.04.16	4	154	M16	29	0,670



REF.	K MORSE		A mm	D mm	d <sub>1</sub> mm				
36.453.03.32	3	ER32	70	50	2-20	45332	50232	19218	0,600
36.453.03.40		ER40	80	63	4-30	45340	50240	19224	0,950
36.453.04.32	4	ER32	60	50	2-20	45332	50232	19218	0,700
36.453.04.40		ER40	81	63	4-30	45340	50240	19224	1,200

\* SUPPLIED WITHOUT WRENCH / \* GELIEFERT OHNE SCHLÜSSEL

REF.	ACCESSORIES / ZUBEHÖR
ERXX	Collets double slot DIN 6499 - Form B (ER) / Spannzangen mit Doppelnut DIN 6499 - Form B (ER)
ERCXX	Sealed collets DIN 6499 (ER) / Abgedichtete Spannzangen DIN 6499 (ER)



ERXX



ERCXX

For more information see page / Für weitere Informationen siehe Seite: K.13, K.17

10  
DIN 208011 13  
DIN 69871-A16  
HSK DIN 69893-117  
TS ISO 26622-118  
PSC ISO 26623-120 23  
JIS B 6339-BT25  
CHIRONBORING HEADS  
BOHRKÖPFEMORSE SHANKS  
MORSE SCHAFTE

DIN 228/B

**CANELA**

PRECISION DRILL CHUCK ARBORS

KEGEL-AUFSTECKDORNE FÜR BOHRFUTTERAUFNAHMEN

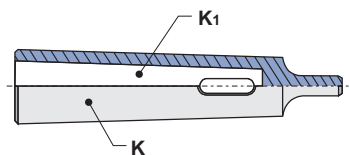
**37.215**

REF.	K MORSE	K <sub>1</sub> MORSE	 kg
37.215.02.01	2	1	0,230
37.215.03.01	3	1	-
37.215.03.02	3	2	-
37.215.04.02	4	2	0,450
37.215.04.03	4	3	-
37.215.05.03	5	3	1,170
37.215.05.04	5	4	1,030

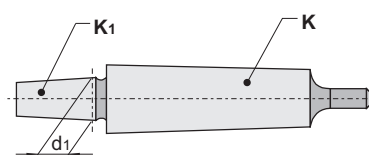

REF.	K MORSE	K <sub>1</sub> DIN	d <sub>1</sub> mm	
37.290.02.12	2	B-12	12,065	0,100
37.290.02.16		B-16	15,733	-
37.290.02.18		B-18	17,780	0,200
37.290.03.12	3	B-12	12,065	0,150
37.290.03.16		B-16	15,733	0,320
37.290.03.18		B-18	17,780	0,400
37.290.04.16	4	B-16	15,733	0,630
37.290.04.18		B-18	17,780	0,660

REF.	ACCESSORIES / ZUBEHÖR
MU	Standard keyless drill chucks DIN 238 / Standard Schnellspann-Bohrfutter DIN 238
MP	Precision keyless drill chucks DIN 238 / Schnellspann-Bohrfutter DIN 238, Genauigkeitsausführung
MK	Self clamping precision keyless drill chucks DIN 238 / Selbstspann-Bohrfutter DIN 238, Genauigkeitsausführung
MH	CNC-UNIVERSAL precision drill chucks DIN 238 / CNC-Universaler Bohrfutter DIN 238, Genauigkeitsausführung



MU



MP



MK



MH

For more information see page / Für weitere Informationen siehe Seite: K.02, K.03, K.04, K.05



10  
DIN 208011 13  
DIN 69871-A16  
HSK DIN 69893-117  
TS ISO 26622-118  
PSC ISO 26623-120 23  
JIS B 6339-BT25  
CHIRONBORING HEADS  
BOHRKÖPFEMORSE SHANKS  
MORSE SCHAFTE

DIN 228-B

**CANELA**

## SELF CLAMPING SHORT PRECISION DRILL CHUCKS

for right turn only

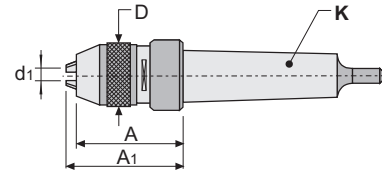

KURZE SELBSTSPANN-BOHRFUTTER, GENAUIGKEIT-AUSFÜHRUNG

nur für Rechtsumdrehung

**37.295**

REF.	K MORSE	d <sub>1</sub> mm	D mm	A mm	A <sub>1</sub> max mm	
37.295.02.08	2	0 - 8	35	56	65	-
37.295.02.13		0-13	51	81	95	1,060
37.295.03.13	3	0-13	51	81	95	-
37.295.03.16		3-16	56	85	98	-
37.295.04.13	4	0-13	51	81	95	1,880
37.295.04.16		3-16	56	85	98	-

\* SUPPLIED WITH WRENCH / \* GELIEFERT MIT SCHLÜSSEL

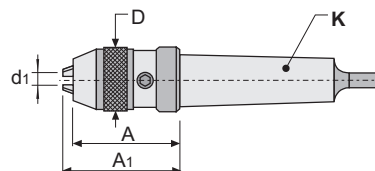

REF.		3 x 
37.295.02.08	50008	60308
37.295.02.13	50013	60308
37.295.03.13	50013	60313
37.295.03.16	50016	60313
37.295.04.13	50013	60313
37.295.04.16	50016	60313



REF.	K MORSE	d <sub>1</sub> mm	D mm	A mm	A <sub>1</sub> max mm	⚖ kg
37.296.02.13	2	1-13	50	85	92	1,120
37.296.03.13	3	1-13	50	85	92	1,270
37.296.03.16		3-16	56	92	99	1,570
37.296.04.13	4	1-13	50	85	92	1,590
37.296.04.16		3-16	56	92	99	1,850
37.296.05.16	5	3-16	56	92	99	2,750

Morse shank being part of the drill chuck, solving coupling problems of any other systems.  
Da der Morse-Schaft ein Teil des Bohrfutters ist, das löst die Kupplungsprobleme von den anderen Systemen.

\* SUPPLIED WITH WRENCH / \* GELIEFERT MIT SCHLÜSSEL

REF.		3 x 
37.296.02.13	50706	60313
37.296.03.13	50706	60313
37.296.03.16	50706	60313
37.296.04.13	50706	60313
37.296.04.16	50706	60313
37.296.05.16	50706	60313

## MANUFACTURED FROM FORGED PARTS

## MATERIAL:

- Alloyed carburized steel at chrome-manganese 1.7131 (16MnCr5).

## EXECUTION:

- Carburized, hardness.
- Surface hardness HRC 58±2 (670±40 HV30)
- Depth minimum 0,5 mm.
- Tensile strength in core minimum 800 N/mm<sup>2</sup> after carburizing.

## ACCURACY:

- Taper according to DIN 254
- Taper angle: tolerance AT 3 DIN 7178 part 1 and DIN 2080 part 1.
- Other tolerances according to DIN 7160 and 7168.
- Taper surface roughness  $R_z < 0,001$  mm.

## HERGESTELLT AUS GESCHMIEDETEN TEILEN

## MATERIAL:

- Legierter Aufgekohlter Stahl mit Chrom-Mangan 1.7131 (16MnCr5).

## KONSTRUKTIONS DATEN:

- Aufgekohlt, gehärtet und angelassen.
- Oberflächenhärte HRC 58±2 (670±40 HV30).
- Aufgekohlt auf minimum 0,5 mm Tiefe.
- Zugfestigkeit im Kern minimum 800 N/mm<sup>2</sup> nach der Aufkohlung.

## GENAUIGKEIT:

- Dorn nach DIN 254.
- Kegelwinkel: Toleranz AT 3 DIN 7178 Teil 1 und DIN 2080 Teil 1.
- Andere Toleranzen entsprechend DIN 7160 und 7168.
- Rauigkeit der Oberfläche  $R_z < 0,001$  mm.

## TOLERANCE AT:

- Indicates the tolerance of size D surface between the real and the theoretical value of the taper conicity.
- This value of surface D must always be less (negative), never more (positive) in order to GUARANTEE a good toolholder fixation at the bigger taper diameter.

## TOLERANZ AT:

- Zeigt die Toleranz auf der Messebene D zwischen dem tatsächlichen Wert der Kegelkonizität und dem theoretischen Wert.
- Dieser Wert auf der Messebene D sollte immer minus (negativ) sein, nie plus (positiv), um für einen guten Halt des Futters in den größeren Durchmesser des Kegels zu garantieren.

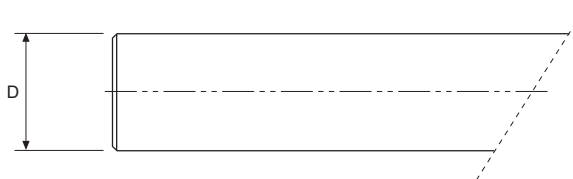
DIN 1835 A/B  
DIN 1835 B+E

B h6 mm					
16	20	25	32	40	50





10  
DIN 2080**CANELA****CYLINDRICAL MODULAR SHANKS**

Front contact extensions for modular tools

**ZYLINDRISCHE MODULAR-SCHÄFTE**

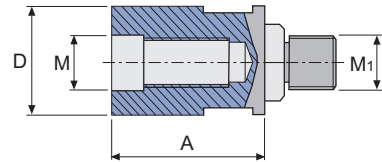
Vorder-Verlängerungen für Modular-Werkzeuge

**06.315**11 13  
DIN 69871-A16  
HSK DIN 69893-117  
TS ISO 26622-118  
PSC ISO 26623-120 23  
JIS B 6339-BT25  
CHIRONBORING HEADS  
BOHRKÖPFEMORSE SHANKS  
MORSE SCHÄFTECYLINDRICAL SHANKS  
ZYLINDRISCHE SCHÄFTE

REF.	D mm	A mm	M mm	M <sub>1</sub> mm	 kg
06.315.08.08	12,7	30	8	8	0,020
06.315.10.10	17,7	35	10	10	0,050
06.315.12.12	20,7	40	12	12	0,075
06.315.16.16	28,7	40	16	16	0,150

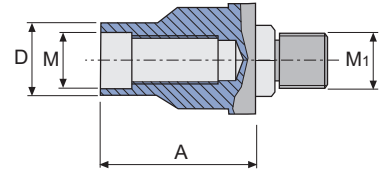

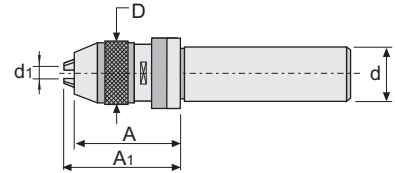

REF.	D mm	A mm	M mm	M <sub>1</sub> mm	kg
06.315.08.10	17,7	30	8	10	0,040
06.315.10.12	20,7	35	10	12	0,060
06.315.12.16	28,7	40	12	16	0,150
06.315.08.12	20,7	40	8	12	0,075
06.315.10.16	28,7	60	10	16	0,240



REF.	d mm	d <sub>1</sub> mm	D mm	A mm	A <sub>1</sub> max mm	kg
40.295.25.08	25	0 - 8	36,0	68	76	-
40.295.30.08	30	0 - 8	36,0	68	76	-
40.295.32.08	32	0 - 8	36,0	68	76	-
40.295.32.13		0-13	50,5	90	101	-
40.295.40.13	40	0-13	50,5	90	101	-
40.295.40.16		3-16	58,0	96	109	-
40.295.50.16	50	3-16	58,0	96	109	-

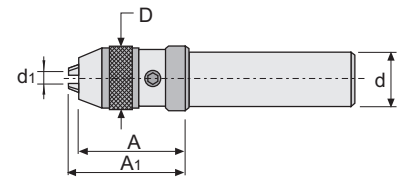

\* SUPPLIED WITH WRENCH / \* GELIEFERT MIT SCHLÜSSEL

REF.			3 x 
40.295.25.08	11206	50008	60308
40.295.30.08	11206	50008	60308
40.295.32.08	11206	50008	60308
40.295.32.13	11108	50013	60313
40.295.40.13	11108	50013	60313
40.295.40.16	11108	50013	60313
40.295.50.16	11108	50016	60313



REF.	d mm	d <sub>1</sub> mm	D mm	A mm	A <sub>1</sub> max mm	 kg
40.296.25.13	25	1-13	50	80,5	87,5	1,170
40.296.32.13	32	1-13	50	80,5	87,5	1,380
40.296.32.16		3-16	56	87,5	94,5	1,640
40.296.40.13	40	1-13	50	80,5	87,5	1,710
40.296.40.16		3-16	57	87,5	94,5	1,970

\* SUPPLIED WITH WRENCH / \* GELIEFERT MIT SCHLÜSSEL

REF.		3 x 
40.296.25.13	50706	60313
40.296.32.13	50706	60313
40.296.32.16	50706	60313
40.296.40.13	50706	60313
40.296.40.16	50706	60313



10  
DIN 208011 13  
DIN 69871-A16  
HSK DIN 69893-117  
TS ISO 26622-118  
PSC ISO 26623-120 23  
JIS B 6339-BT25  
CHIRONBORING HEADS  
BOHRKÖPFEMORSE SHANKS  
MORSE SCHAFTECYLINDRICAL SHANKS  
ZYLINDRISCHE SCHAFTE**CANELA****CNC-UNIVERSAL PRECISION DRILL CHUCKS**

for left and right hand turn

**CNC-UNIVERSAL BOHRFUTTER, GENAUIGKEIT-AUSFÜHRUNG**

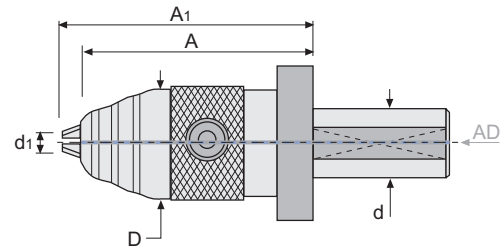

für Links- und Rechtsumdrehung

**DIN 1835-A****43.296**

REF.	d mm	d <sub>1</sub> mm	D mm	A mm	A <sub>1</sub> max mm	⚖ kg
43.296.25.13	25	1-13	50	80,5	87,5	1,190
43.296.32.13	32	1-13	50	80,5	87,5	1,390
43.296.32.16		3-16	56	87,5	94,5	1,650
43.296.40.13	40	1-13	50	80,5	87,5	1,720
43.296.40.16		3-16	57	87,5	94,5	1,990

CENTRAL COOLANT SUPPLY  
KÜHLMITTEL DURCH DIE MITTE

\* SUPPLIED WITH WRENCH / \* GELIEFERT MIT SCHLÜSSEL



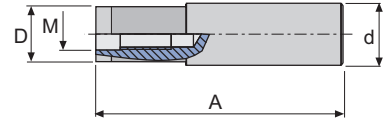

REF.		3 x 
43.296.25.13	50706	60313
43.296.32.13	50706	60313
43.296.32.16	50706	60313
43.296.40.13	50706	60313
43.296.40.16	50706	60313

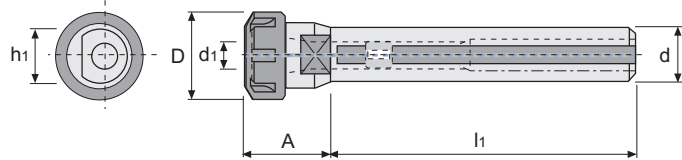

REF.	d mm	A mm	M mm	D mm	⚖️ kg
40.315.20.10	20	125	M10	18	0,300
40.315.25.12	25	125	M12	21	0,450
40.315.32.16	32	150	M16	30	-
40.315.12.06/125HD	12	125	M6	10	0,230
40.315.16.08/125HD	16	125	M8	14	0,405
40.315.12.06/150HD	12	150	M6	10	0,265
40.315.16.08/150HD	16	150	M8	14	0,470
40.315.20.10/150HD	20	150	M10	18	0,755
40.315.25.12/150HD	25	150	M12	21	1,105
40.315.20.10/200HD	20	200	M10	18	1,005
40.315.25.12/200HD	25	200	M12	21	1,460
40.315.32.16/250HD	32	250	M16	30	-

HD= Antivibration shank (heavy metal)  
 HD= Schwingungsgedämpfter Schaft (Schwermetall)



REF.	d mm		d <sub>1</sub> mm	A mm	l <sub>1</sub> mm	D mm	h <sub>1</sub> mm				
40.453.20.16/050	20	ER16	0,5-10	31,5	50	32	19,5	45316	50216	19210	0,150
40.453.20.16/100		ER16	0,5-10	31,5	100	32	19,5	45316	50216	19210	0,260
40.453.20.16/150		ER16	0,5-10	31,5	150	32	19,5	45316	50216	19210	0,350
40.453.20.25/050		ER25	1,0-16	46,5	50	42	19,5	45325	50225	19216	0,300
40.453.20.25/100		ER25	1,0-16	46,5	100	42	19,5	45325	50225	19216	0,380
40.453.20.25/150		ER25	1,0-16	46,5	150	42	19,5	45325	50225	19216	0,470
40.453.20.32/050	32	ER32	2,0-20	54,5	50	50	19,5	45332	50232	19222	0,440
40.453.20.32/100		ER32	2,0-20	54,5	100	50	19,5	45332	50232	19222	0,520
40.453.25.20/050	25	ER20	1,0-13	33,5	50	35	24,0	45320	50220	19212	0,250
40.453.25.20/100		ER20	1,0-13	33,5	100	35	24,0	45320	50220	19212	0,390
40.453.25.20/150		ER20	1,0-13	33,5	150	35	24,0	45320	50220	19212	0,520
40.453.25.25/050		ER25	1,0-16	46,5	50	42	24,0	45325	50225	19216	0,350
40.453.25.25/100		ER25	1,0-16	46,5	100	42	24,0	45325	50225	19216	0,420
40.453.25.25/150		ER25	1,0-16	46,5	150	42	24,0	45325	50225	19216	0,540
40.453.25.32/050	32	ER32	2,0-20	52,5	50	50	24,0	45332	50232	19222	0,440
40.453.25.32/100		ER32	2,0-20	52,5	100	50	24,0	45332	50232	19222	0,540
40.453.25.40/050	40	ER40	3,0-30	60,5	50	63	24,0	45340	50240	19224	0,730
40.453.32.32/050	32	ER32	2,0-20	52,5	50	50	31,0	45332	50232	19222	0,550
40.453.32.40/050		ER40	3,0-30	60,5	50	63	31,0	45340	50240	19224	0,860
40.453.40.32/075	40	ER32	2,0-20	52,0	75	50	38,0	45332	50232	19222	0,830
40.453.40.40/075		ER40	3,0-30	60,5	75	63	38,0	45340	50240	19224	1,240

WITH CLAMPING FLAT FOR CNC LATHES AND TURRET LATHES

MIT SPANFLÄCHE FÜR CNC-DREHMASCHINEN UND REVOLVERDREHBÄNKE

\* SUPPLIED WITHOUT WRENCH / \* GELIEFERT OHNE SCHLÜSSEL

REF.	ACCESSORIES / ZUBEHÖR
ERXX	Collets double slot DIN 6499 - Form B (ER) / Spannanzgen mit Doppelnut DIN 6499 - Form B (ER)
ERCXX	Sealed collets DIN 6499 (ER) / Abgedichtete Spannanzgen DIN 6499 (ER)
ERTXX	Collets DIN 6499 - Form Canela (ER) / Spannanzgen DIN 6499 - Form Canela (ER)



ERXX



ERCXX



ERTXX

For more information see page / Für weitere Informationen siehe Seite: K.13, K.17, K.19





## LONG COLLET CHUCKS FOR DIN 6499 (ER) COLLETS

for tools with cylindrical shank

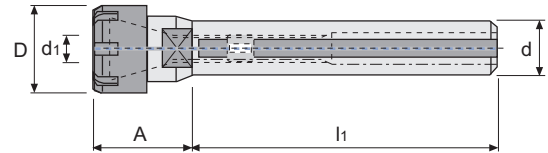
## LANGE SPANNZANGENFUTTER FÜR SPANNZANGEN DIN 6499 (ER)

für Werkzeuge mit Zylinderschaft



REF.	d mm		d <sub>1</sub> mm	A mm	l <sub>1</sub> mm	D mm				
40.455.12.16/080	12	ER16	0,5-10	40,5	80	22	45516	50916	19106	0,100
40.455.16.16/050	16	ER16	0,5-10	36,5	50	22	45516	50916	19210	0,100
40.455.16.16/100		ER16	0,5-10	36,5	100	22	45516	50916	19210	0,170
40.455.16.16/150		ER16	0,5-10	36,5	150	22	45516	50916	19210	0,230
40.455.16.20/050	20	ER20	1,0-13	33,5	50	28	45520	50920	19210	0,140
40.455.16.20/100		ER20	1,0-13	33,5	100	28	45520	50920	19210	0,190
40.455.16.20/150		ER20	1,0-13	33,5	150	28	45520	50920	19210	0,250
40.455.20.16/050	20	ER16	0,5-10	30,5	50	22	45516	50916	19210	0,130
40.455.20.16/100		ER16	0,5-10	30,5	100	22	45516	50916	19210	-
40.455.20.16/141		ER16	1,0-10	34,0	141	22	45516	50916	19210	-
40.455.20.16/150	ER16	0,5-10	30,5	150	22	45516	50916	19210	0,320	
40.455.20.16/226	ER16	1,0-10	34,0	226	22	45516	50916	19210	-	
40.455.20.20/050	20	ER20	1,0-13	33,5	50	28	45520	50920	19212	-
40.455.20.20/100		ER20	1,0-13	33,5	100	28	45520	50920	19212	0,230
40.455.20.20/150		ER20	1,0-13	33,5	150	28	45520	50920	19212	0,300
40.455.25.20/223	25	ER20	1,0-13	37,0	223	28	45525	50925	19216	-
40.455.32.25/218	32	ER25	1,0-16	42,0	218	35	45532	50932	19222	-

WITH "MINI" COLLET NUT  
MIT SPANNMUTTER "MINI"

\* SUPPLIED WITHOUT WRENCH / \* GELIEFERT OHNE SCHLÜSSEL

REF.	ACCESSORIES / ZUBEHÖR
ERXX	Collets double slot DIN 6499 - Form B (ER) / Spannzangen mit Doppelnut DIN 6499 - Form B (ER)
ERCXX	Sealed collets DIN 6499 (ER) / Abgedichtete Spannzangen DIN 6499 (ER)
ERTXX	Collets DIN 6499 - Form Canela (ER) / Spannzangen DIN 6499 - Form Canela (ER)



ERXX









ERCXX

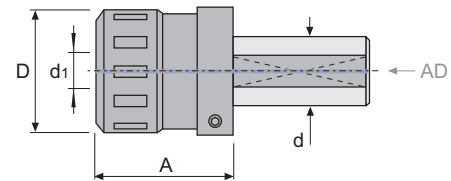

ERTXX

For more information see page / Für weitere Informationen siehe Seite: K.13, K.17, K.19



REF.	d mm		d <sub>1</sub> mm	A mm	D mm				
43.457.25.32	25	ER32	2-20	79	54	45732	19006	50704	1,210
43.457.32.32	32	ER32	2-20	79	54	45732	19006	50704	1,540
43.457.40.40	40	ER40	3-30	88	65	45740	19010	50706	2,790

The alternative to hydraulic or other systems.  
High tightening and precision.  
Central coolant supply.

Die Alternative zu hydraulischen und anderen  
Systemen.  
Hohes Anzugsmoment und hohe Genauigkeit.  
Kühlmittel durch die Mitte.

\* SUPPLIED WITH WRENCH / \* GELIEFERT MIT SCHLÜSSEL

REF.	ACCESSORIES / ZUBEHÖR
ERXX	Collets double slot DIN 6499 - Form B (ER) / Spannzangen mit Doppelnut DIN 6499 - Form B (ER)
ERCXX	Sealed collets DIN 6499 (ER) / Abgedichtete Spannzangen DIN 6499 (ER)



ERXX



ERCXX

For more information see page / Für weitere Informationen siehe Seite: K.13, K.17



FORM A

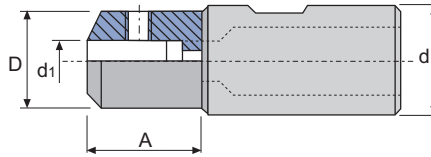

FORM B

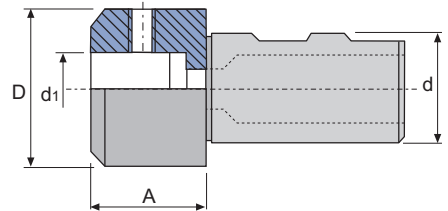

REF.	d mm	d <sub>1</sub> H5 mm	A mm	D mm	FORM	kg
42.300.20.06	20	6	30	25	B	0,170
42.300.20.08		8	30	28	B	0,200
42.300.20.10		10	35	35	B	0,330
42.300.20.12		12	35	42	B	0,410
42.300.20.14		14	35	44	B	0,410
42.300.20.16		16	60	48	B	0,790
42.300.25.06	25	6	30	25	A	0,250
42.300.25.08		8	30	28	A	0,275
42.300.25.10		10	35	35	B	0,410
42.300.25.12		12	35	42	B	0,460
42.300.25.14		14	35	44	B	0,500
42.300.25.16		16	40	48	B	0,600
42.300.32.06	32	6	30	25	A	0,400
42.300.32.08		8	30	28	A	0,460
42.300.32.10		10	35	35	B	0,520
42.300.32.12		12	35	42	B	0,570
42.300.32.14		14	35	44	B	0,590
42.300.32.16		16	40	48	B	0,700
42.300.32.18		18	40	50	B	0,750
42.300.32.20		20	40	52	B	0,770

REF.	
42.300.20.06	15106
42.300.20.08	15108
42.300.20.10	15110
42.300.20.12	15212
42.300.20.14	15212
42.300.20.16	15314
42.300.25.06	15106
42.300.25.08	15108
42.300.25.10	15110
42.300.25.12	15212
42.300.25.14	15212
42.300.25.16	15314
42.300.32.06	15106
42.300.32.08	15108
42.300.32.10	15110
42.300.32.12	15212
42.300.32.14	15212
42.300.32.16	15314
42.300.32.18	15314
42.300.32.20	15216

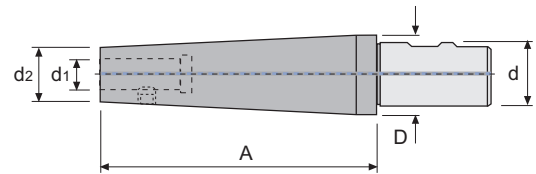

REF.	d mm	d <sub>1</sub> H5 mm	A mm	D mm	FORM	d <sub>2</sub> mm	Kg
42.311.40.08	40	8	175	50	C	16	1,210
42.311.40.10		10	175	50	C	20	
42.311.40.12		12	175	50	C	22	1,540
42.311.40.16		16	175	50	C	28	
42.311.40.20		20	175	50	C	34	2,790
42.311.40.25		25	175	50	C	40	
42.311.40.32		32	180	50	C	46	

REF.	
42.311.40.08	14008
42.311.40.10	14008
42.311.40.12	14008
42.311.40.16	14010
42.311.40.20	14010
42.311.40.25	14010
42.311.40.32	14010

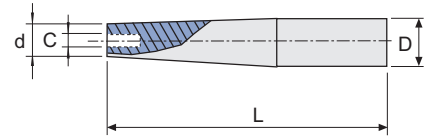
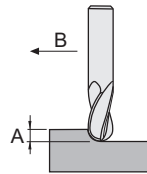

REF.	C mm	d mm	L mm	D mm	A mm	B mm			
42.454.20.06	6	12	150	20	1,0	0,05 x Z	50204	50201	0,180
42.454.20.08	8	15	150	20	1,0	0,05 x Z	50204	50201	0,350
42.454.20.10	10	18	150	20	1,5	0,05 x Z	50205	50201	0,450
42.454.20.12	12	20	150	20	1,5	0,05 x Z	50205	50201	0,530

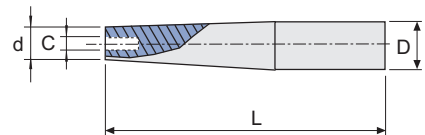
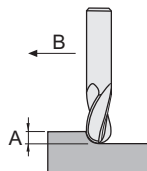

REF.	C mm	d mm	L mm	D mm	A mm	B mm			
42.454.20.06	6	12	150	20	1,0	0,05 x Z	50204	50201	0,180
42.454.20.08	8	15	150	20	1,0	0,05 x Z	50204	50201	0,350
42.454.20.10	10	18	150	20	1,5	0,05 x Z	50205	50201	0,450
42.454.20.12	12	20	150	20	1,5	0,05 x Z	50205	50201	0,530

**Instructions:**

To obtain from CLS extensions a proper operation is very important to insert the end mill completely. CLS handle could get damaged due to a bad end mill position.

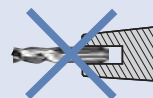
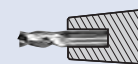
Incorrect  
RichtigCorrect  
falsch**Instruktionen:**

Um von den CLS-Verlängerungen eine richtige Operation zu ermöglichen, ist es sehr wichtig, den Hartmetallfräser völlig einzufügen. Die CLS Aufnahme könnte wegen einer schlechten Positionierung des Hartmetallfräasers beschädigt werden.









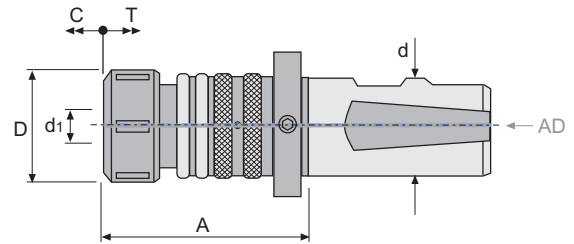

**TAPPING HEAD WITH AXIAL COMPENSATION**

hold tape with DIN 6499 (ER) collets and with inner coolant

**GEWINDESCHNEID-WECHSELFUTTER MIT AXIAL-LÄNGENAUSGLEICH**

Befestigung mit Spannzangen DIN 6499 (ER) und mit Innenkühlung



REF.	d mm			A mm	D mm	C mm	T mm			
42.610.20.16	20	ER16	M3-M12	65	28	5,5	6,0	45316	50216	0,430
42.610.25.16	25	ER16	M3-M12	67	28	5,5	6,0	45316	50216	0,440
42.610.25.25		ER25	M4-M20	90	42	10,5	7,5	45325	50225	0,840
42.610.25.40		ER40	M8-M33	106	63	10,0	10,0	45340	50240	1,320
42.610.32.40	32	ER40	M8-M33	106	63	10,0	10,0	45340	50240	1,480

Compensation in compression (C) and tension (T).  
Compression can be blocked by turning the rear ring (A).  
Control of threading depth.  
Central coolant supply.

Ausgleich der Kompression (C) und der Traktion (T).  
Die Kompression kann mit dem Ring (A) blockiert werden.  
Kontrolle der Gewindetiefe.  
Kühlmittel durch die Mitte.

\* SUPPLIED WITH WRENCH / \* GELIEFERT MIT SCHLÜSSEL

REF.	ACCESSORIES / ZUBEHÖR
ERXX	Collets double slot DIN 6499 - Form B (ER) / Spannzangen mit Doppelnut DIN 6499 - Form B (ER)
ERCXX	Sealed collets DIN 6499 (ER) / Abgedichtete Spannzangen DIN 6499 (ER)
ERTXX	Collets DIN 6499 - Form Canela (ER) / Spannzangen DIN 6499 - Form Canela (ER)
40.453..	Collet chucks for DIN 6499 (ER) collets / Spannzangenfutter für DIN 6499 (ER) Spannzangen
40.455..	Long collet chucks for DIN 6499 (ER) collets / Lange Spannzangenfutter für DIN 6499 (ER) Spannzangen



ERXX



ERCXX



ERTXX







40.453..

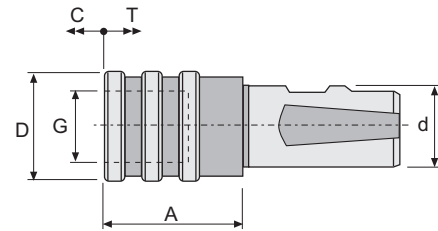

40.455..

For more information see page / Für weitere Informationen siehe Seite: K.13, K.17, K.19, J.08, J.09



REF.	d mm	G Nº. Ø		A mm	D mm	C mm	T mm			
42.620.20.12	20	1 19	M3-M12	41	38	9	9	710XX	750XX	0,350
42.620.20.20		2 31	M8-M20	63	55	15	15	720XX	760XX	0,860
42.620.25.12	25	1 19	M3-M12	41	38	9	9	710XX	750XX	0,430
42.620.25.20		2 31	M8-M20	63	55	15	15	720XX	760XX	0,880
42.620.32.12	32	1 19	M3-M12	41	38	9	9	710XX	750XX	0,600
42.620.32.20		2 31	M8-M20	63	55	15	15	720XX	760XX	1,050
42.620.32.33		3 48	M14-M33	97	79	24	24	730XX	770XX	2,690
42.620.40.12	40	1 19	M3-M12	41	38	9	9	710XX	750XX	-
42.620.40.20		2 31	M8-M20	63	55	15	15	720XX	760XX	-
42.620.40.33		3 48	M14-M33	97	79	24	24	730XX	770XX	-

COMPENSATION IN COMPRESSION (C) AND TENSION (T)  
 AUSGLEICH DER KOMPRESSIION (C) UND DER TRAKTION (T)

REF.	ACCESSORIES / ZUBEHÖR
710XX..730XX	Quick change adpaters without overload clutch / Schnellwechseleinsätze ohne Sicherheitskupplung
750XX..770XX	Quick change adpaters with overload clutch / Schnellwechseleinsätze mit Sicherheitskupplung



710XX..730XX



750XX..770XX

For more information see page / Für weitere Informationen siehe Seite: K.06, K.07

10  
DIN 2080

11 13  
DIN 69871-A

16  
HSK DIN 69893-1

17  
TS ISO 26622-1

18  
PSC ISO 26623-1

20 23  
JIS B 6339-BT

25  
CHIRON



BORING HEADS  
BOHRKOPFTE

MORSE SHANKS  
MORSE SCHAFTTE

CYLINDRICAL SHANKS  
ZYLINDRISCHE SCHAFTTE

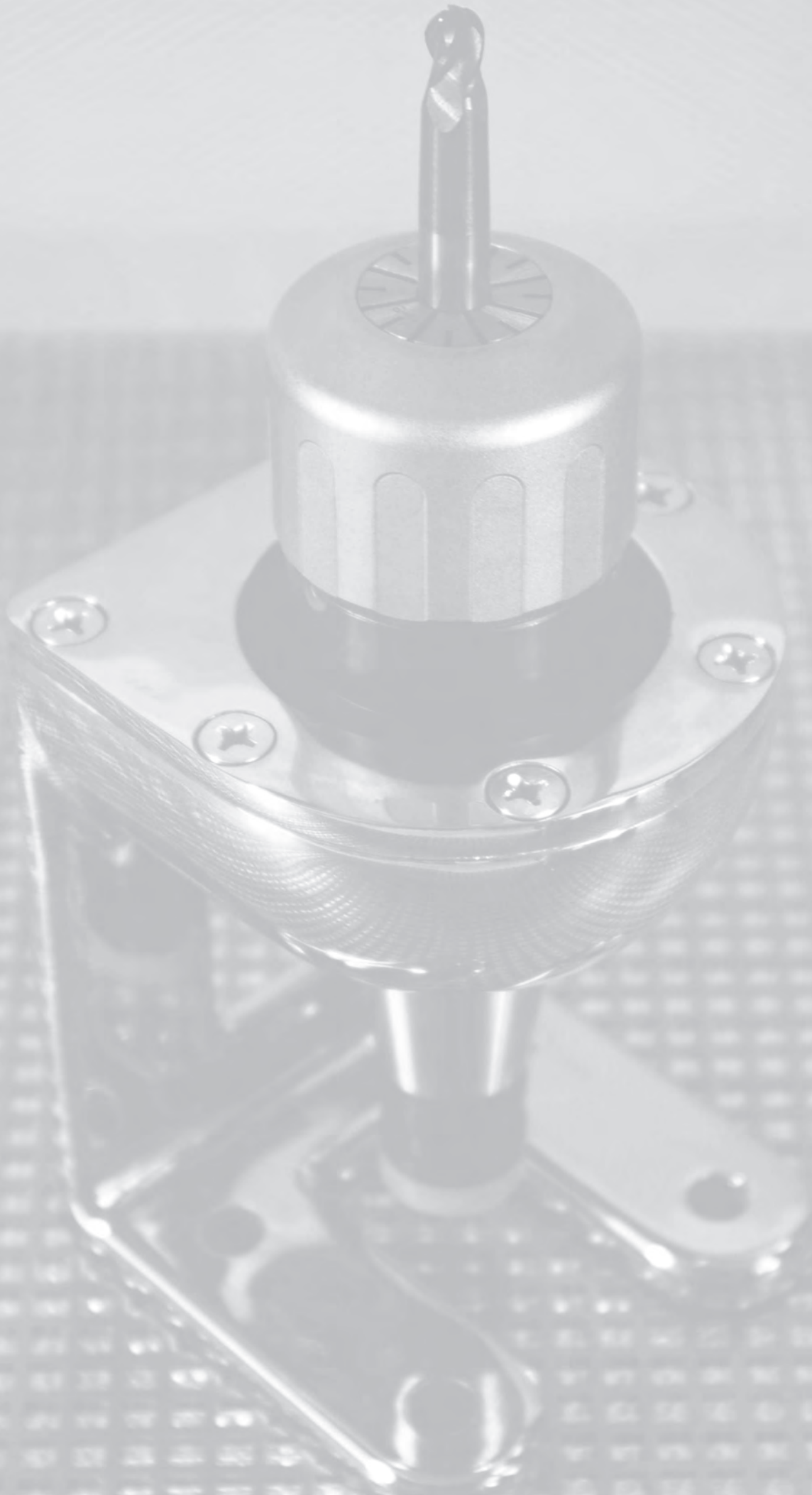
ACCESSORIES  
ZUBEHÖR



<p><b>MU</b></p>  <p>K.02</p>	<p><b>MP</b></p>  <p>K.03</p>	<p><b>MK</b></p>  <p>K.04</p>	<p><b>MH</b></p>  <p>K.05</p>	<p><b>7_0XX</b></p>  <p>K.06</p>
<p><b>7_0XX</b></p>  <p>K.07</p>	<p><b>BXX</b></p>  <p>K.10</p>	<p><b>ERXX</b></p>  <p>K.13</p>	<p><b>ERBXX</b></p>  <p>K.16</p>	<p><b>ERCXX</b></p>  <p>K.17</p>
<p><b>ERTXX</b></p>  <p>K.19</p>	<p><b>50XX</b></p>  <p>K.20</p>	<p><b>50XX</b></p>  <p>K.20</p>	<p><b>50XX</b></p>  <p>K.20</p>	<p><b>50XX</b></p>  <p>K.20</p>
<p><b>433XX</b></p>  <p>K.21</p>	<p><b>431XX</b></p>  <p>K.21</p>	<p><b>453XX</b></p>  <p>K.22</p>	<p><b>451XX</b></p>  <p>K.22</p>	<p><b>455XX</b></p>  <p>K.23</p>
<p><b>456XX</b></p>  <p>K.23</p>	<p><b>457XX</b></p>  <p>K.23</p>	<p><b>91..</b></p>  <p>K.24</p>	<p><b>92..</b></p>  <p>K.26</p>	<p><b>02.70/80</b></p>  <p>K.27</p>
<p><b>02.71/81</b></p>  <p>K.27</p>	<p><b>SET-ER</b></p>  <p>K.15</p>			

**CANELA**

STANDARD KEYLESS DRILL CHUCKS

SELBSTPANN-BOHRFUTTER, STANDARD-AUSFÜHRUNG

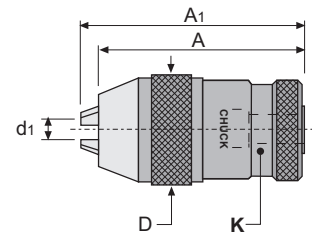

REF.	K DIN238	d <sub>1</sub> mm	D mm	A mm	A <sub>1</sub> mm	⚖️ kg
MU08B12	B-12	0 - 8	36	68	74	0,340
MU10B12	B-12	0-10	36	70	77	0,610
MU13B16	B-16	0-13	40	88	99	0,940
MU16B16	B-16	3-16	46	100	109	1,150
MU16B18	B-18		46	100	109	1,140
MU20B18	B-18	5-20	64	127	140	2,250

REF.	3 x 
MU08B12	60328
MU10B12	60330
MU13B16	60333
MU16B16	60336
MU16B18	60336
MU20B18	60336

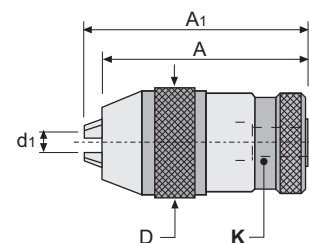

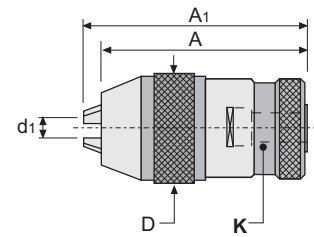

REF.	K DIN238	d <sub>1</sub> mm	D mm	A mm	A <sub>1</sub> mm	⚖️ kg
MP08B12	B-12	0 - 8	36,0	64,5	72,5	0,500
MP10B12	B-12	0-10	44,5	80,5	92,0	-
MP10B16	B-16		44,5	80,5	92,0	0,740
MP13B16	B-16	0-13	51,5	91,5	103,0	0,990
MP16B16	B-16	3-16	57,5	94,5	108,5	-
MP16B18	B-18		57,5	94,5	108,5	1,270

REF.	3 x 
MP08B12	60308
MP10B12	60310
MP10B16	60310
MP13B16	60313
MP16B16	60313
MP16B18	60313



REF.	K DIN238	d <sub>1</sub> mm	D mm	A mm	A <sub>1</sub> mm	⚖️ kg
MK08B12	B-12	0 - 8	36,0	64,5	72,5	0,480
MK10B12	B-12	0-10	44,5	80,5	92,0	-
MK10B16	B-16		44,5	80,5	92,0	-
MK13B16	B-16	0-13	51,5	91,5	103,0	1,150
MK16B16	B-16	3-16	57,5	94,5	108,5	-
MK16B18	B-18		57,5	94,5	108,5	1,260

REF.		3 x 
MK08B12	50008	60308
MK10B12	50010	60310
MK10B16	50010	60310
MK13B16	50013	60313
MK16B16	50016	60313
MK16B18	50016	60313

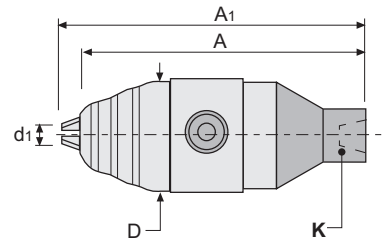

REF.	K DIN238	d <sub>1</sub> mm	D mm	A mm	A <sub>1</sub> max mm	kg
MH13B16	B-16	0-13	50	100	107	-
MH16B18	B-18	3-16	56	108	115	1,460

Drill chuck for the coupling over DIN 238 shafts. High tightening.  
Bohrfutter für die Kupplung auf Schaft DIN 238. Hoher Drehmoment.

**\* SUPPLIED WITH WRENCH / \* GELIEFERT MIT SCHLÜSSEL**

REF.		3 x
MH13B16	50706	60313
MH16B18	50706	60313



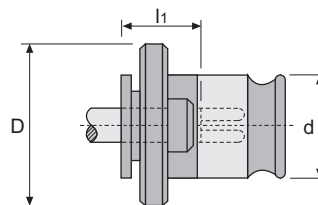

REF.	DIN d <sub>1</sub> x a mm	d mm	D mm	l <sub>1</sub> mm	
71002	2,8 x 2,1	19	30	11	-
71003	3,5 x 2,7	19	30	11	-
71004	4,0 x 3,0	19	30	11	-
71005	4,5 x 3,4	19	30	11	-
71006	5,5 x 4,3	19	30	11	-
71007	6,0 x 4,9	19	30	11	-
71008	7,0 x 5,5	19	30	11	-
71009	8,0 x 6,2	19	30	11	-
71010	9,0 x 7,0	19	30	11	-
71011	10,0 x 8,0	19	30	11	-
71012	11,0 x 9,0	19	30	11	-
71013	12,0 x 9,0	19	30	11	-
72007	6,0 x 4,9	31	48	11	-
72008	7,0 x 5,5	31	48	11	-
72009	8,0 x 6,2	31	48	11	-
72010	9,0 x 7,0	31	48	11	-
72011	10,0 x 8,0	31	48	11	-
72012	11,0 x 9,0	31	48	11	-
72013	12,0 x 9,0	31	48	11	-
72014	14,0 x 11,0	31	48	11	-
72015	16,0 x 12,0	31	48	11	-
72016	18,0 x 14,5	31	48	11	-
72017	20,0 x 16,0	31	48	11	-
72018	22,0 x 18,0	31	48	11	-
73012	11,0 x 9,0	48	70	14	0,900
73013	12,0 x 9,0	48	70	14	-
73014	14,0 x 11,0	48	70	14	-
73015	16,0 x 12,0	48	70	14	0,890
73016	18,0 x 14,5	48	70	14	-
73017	20,0 x 16,0	48	70	14	-
73018	22,0 x 18,0	48	70	14	-
73019	25,0 x 20,0	48	70	14	-
73020	28,0 x 22,0	48	70	14	0,730
73021	32,0 x 24,0	48	70	14	0,720
73022	36,0 x 29,0	48	70	14	-

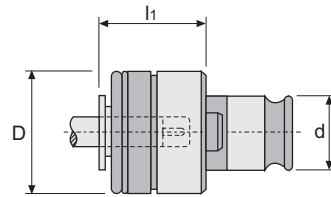

REF.	DIN d <sub>1</sub> x a mm	d mm	D mm	l <sub>1</sub> mm	⚠ kg
75002	2,8 x 2,1	19	32	25	0,170
75003	3,5 x 2,7	19	32	25	-
75004	4,0 x 3,0	19	32	25	-
75005	4,5 x 3,4	19	32	25	-
75006	5,5 x 3,4	19	32	25	-
75007	6,0 x 4,9	19	32	25	-
75008	7,0 x 5,5	19	32	25	0,165
75009	8,0 x 6,2	19	32	25	-
75010	9,0 x 7,0	19	32	25	-
75011	10,0 x 8,0	19	32	25	-
75012	11,0 x 9,0	19	32	25	-
75013	12,0 x 9,0	19	32	25	0,140
76007	6,0 x 4,9	31	50	34	0,540
76008	7,0 x 5,5	31	50	34	-
76009	8,0 x 6,2	31	50	34	-
76010	9,0 x 7,0	31	50	34	-
76011	10,0 x 8,0	31	50	34	-
76012	11,0 x 9,0	31	50	34	-
76013	12,0 x 9,0	31	50	34	-
76014	14,0 x 11,0	31	50	34	0,520
76015	16,0 x 12,0	31	50	34	-
76016	18,0 x 14,5	31	50	34	-
76017	20,0 x 16,0	31	50	34	-
76018	22,0 x 18,0	31	50	34	-
77010	9,0 x 7,0	48	72	45	1,530
77012	11,0 x 7,0	48	72	45	-
77013	12,0 x 9,0	48	72	45	-
77014	14,0 x 11,0	48	72	45	-
77015	16,0 x 12,0	48	72	45	-
77016	18,0 x 14,5	48	72	45	-
77017	20,0 x 16,0	48	72	45	-
77018	22,0 x 18,0	48	72	45	-
77019	25,0 x 20,0	48	72	45	1,520
77020	28,0 x 22,0	48	72	45	-
77021	32,0 x 24,0	48	72	45	-
77022	36,0 x 29,0	48	72	45	-



"XX"	Ø x □	DIN 352	DIN 5156 5157	DIN 371	DIN 374	DIN 376	DIN 371	DIN 374 376
01	2,5 x 2,1	M 1/1,8		M 1/1,8	M 3,5	M 3,5	1/16"	
							Nr. 0/1	
02	2,8 x 2,1	M 2		M 2	M 4	M 4	3/32"	
		M 2,2		M 2,2			Nr. 2	
		M 2,5		M 2,5			Nr. 3	
03	3,5 x 2,7	M 3		M 3	M 5	M 5	1/8"	
							Nr. 4	
							Nr. 5	
04	4 x 3	M 3,5		M 3,5	M 5,5	M 5,5	Nr. 6	
05	4,5 x 3,4	M 4		M 4	M 6	M 6	5/32"	
							Nr. 8	
06	5,5 x 4,3				M 7	M 7		
07	6 x 4,9	M 4,5	G 1/16"	M 4,5	M 8	M 8	Nr. 10/12	
		M 5		M 5			3/16"	1/4"
		M 6		M 6			7/32"	5/16"
		M 7						
		M 8						
08	7 x 5,5	M 10	G 1/8"	M 7	M 10	M 10	1/4"	3/8"
09	8 x 6,2	M 11		M 8	M 11	M 11	5/16"	7/16"
10	9 x 7	M 12		M 9	M 12	M 12	3/8"	1/2"
11	10 x 8			M 10				
12	11 x 9	M 14	G 1/4"		M 14	M 14	9/16"	
13	12 x 9	M 16	G 3/8"		M 16	M 16	5/8"	
14	14 x 11	M 18			M 18	M 18	11/16"	
								3/4"
15	16 x 12	M 20	G 1/2"		M 20	M 20	13/16"	
16	18 x 14,5	M 22	G 5/8"		M 22	M 22	7/8"	
		M 24			M 24	M 24	15/16"	
17	20 x 16	M 27	G 3/4"		M 27	M 27	1"	
18	22 x 18	M 30	G 7/8"		M 30	M 30	1.1/8"	
19	25 x 20	M 33	G 1"		M 33	M 33	1.1/4"	
20	28 x 22	M 36	G 1.1/8"		M 36	M 36	1.3/8"	
		M 39	G 1.1/4"		M 39	M 39	1.1/2"	
21	32 x 24	M 42			M 42	M 42	1.5/8"	
		M 45	G 1.3/8"		M 45	M 45	1.3/4"	
22	36 x 29	M 48	G 1.1/2"		M 48	M 48		1.7/8"

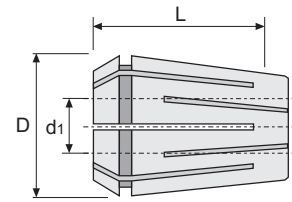

A = REDUCED SHANK / A = REDUZIERTE AUFNAHME

B = REINFORCED SHANK / B = VERSTÄRKT AUFNAHME

"XX"	Ø X □	M - MF		UNC - UNF		BSW - BSF		BA
		A	B	A	B	A	B	A
30	2,24 x 1,8	M 3		Nr. 5		1/8		
31	2,5 x 2	M 3,5	M 1,0/2	Nr. 6	Nr. 0			Nr. 11
					Nr. 1			Nr. 10
								Nr. 9
32	2,8 x 2,24		M 2,2		Nr. 2			Nr. 8
			M 2,5		Nr. 3			Nr. 7
								Nr. 6
33	3,15 x 2,5	M 4	M 3		Nr. 4		1/8	Nr. 5
				Nr. 8	Nr. 5			
34	3,55 x 2,8	M 4,5	M 3,5	Nr. 10	Nr. 6	3/16		Nr. 4
35	4 x 3,15	M 5	M 4	Nr. 12		7/32		
36	4,5 x 3,55	M 6	M 4,5	1/4	Nr. 8	1/4		Nr. 3
37	5 x 4		M 5		Nr. 10		3/16	Nr. 2
38	5,6 x 4,5	M 7			Nr. 12	9/32	7/32	Nr. 1
39	6,3 x 5	M 8	M 6	5/16	1/4	5/16	1/4	Nr. 0
40	7,1 x 5,6	M 9	M 7	3/8		3/8	9/32	
41	8 x 6,3	M 10	M 8	7/16	5/16	7/16	5/16	
42	9 x 7,1	M 12	M 9	1/2		1/2		
11	10 x 8		M 10		3/8		3/8	
43	11,2 x 9	M 14		9/16		9/16		
44	12,5 x 10	M 16		5/8		5/8		
45	14 x 11,2	M 18				11/16		
		M 20		3/4		3/4		
46	16 x 12,5	M 22		7/8		7/8		
47	18 x 14	M 24		1		1		
17	20 x 16	M 27		1.1/8		1.1/8		
		M 30						
48	22,4 x 18	M 33		1.1/4		1.1/4		
19	25 x 20	M 36		1.3/8		1.3/8		
49	28 x 22,4	M 39		1.1/2		1.1/2		
		M 42				1.5/8		
50	31,5 x 25	M 45		1.3/4		1.3/4		
		M 48						
51	35,45 x 28	M 52		2		2		



REF.		d1 mm	D mm	L mm	 Kg
B1602.0	B16	2,0-1,5	25,5	40	0,090
B1602.5	B16	2,5-2,0	25,5	40	-
B1603.0	B16	3,0-2,5	25,5	40	-
B1603.5	B16	3,5-3,0	25,5	40	-
B1604.0	B16	4,0-3,5	25,5	40	-
B1604.5	B16	4,5-4,0	25,5	40	-
B1605.0	B16	5,0-4,5	25,5	40	-
B1605.5	B16	5,5-5,0	25,5	40	-
B1606.0	B16	6,0-5,5	25,5	40	-
B1606.5	B16	6,5-6,0	25,5	40	-
B1607.0	B16	7,0-6,5	25,5	40	-
B1607.5	B16	7,5-7,0	25,5	40	-
B1608.0	B16	8,0-7,5	25,5	40	-
B1608.5	B16	8,5-8,0	25,5	40	-
B1609.0	B16	9,0-8,5	25,5	40	0,090
B1609.5	B16	9,5-9,0	25,5	40	-
B1610.0	B16	10,0-9,5	25,5	40	-
B1610.5	B16	10,5-10,0	25,5	40	-
B1611.0	B16	11,0-10,5	25,5	40	-
B1611.5	B16	11,5-11,0	25,5	40	-
B1612.0	B16	12,0-11,5	25,5	40	-
B1612.5	B16	12,5-12,0	25,5	40	-
B1613.0	B16	13,0-12,5	25,5	40	-
B1613.5	B16	13,5-13,0	25,5	40	-
B1614.0	B16	14,0-13,5	25,5	40	-
B1614.5	B16	14,5-14,0	25,5	40	-
B1615.0	B16	15,0-14,5	25,5	40	-
B1615.5	B16	15,5-15,0	25,5	40	-
B1616.0	B16	16,0-15,5	25,5	40	0,060
B2503.0	B25	3,0-2,5	35,5	52	0,200
B2503.5	B25	3,5-3,0	35,5	52	-
B2504.0	B25	4,0-3,5	35,5	52	-
B2504.5	B25	4,5-4,0	35,5	52	-
B2505.0	B25	5,0-4,5	35,5	52	-
B2505.5	B25	5,5-5,0	35,5	52	-
B2506.0	B25	6,0-5,5	35,5	52	-
B2506.5	B25	6,5-6,0	35,5	52	-
B2507.0	B25	7,0-6,5	35,5	52	-
B2507.5	B25	7,5-7,0	35,5	52	-
B2508.0	B25	8,0-7,5	35,5	52	-
B2508.5	B25	8,5-8,0	35,5	52	-
B2509.0	B25	9,0-8,5	35,5	52	-
B2509.5	B25	9,5-9,0	35,5	52	-
B2510.0	B25	10,0-9,5	35,5	52	-
B2510.5	B25	10,5-10,0	35,5	52	0,250
B2511.0	B25	11,0-10,5	35,5	52	-
B2511.5	B25	11,5-11,0	35,5	52	-
B2512.0	B25	12,0-11,5	35,5	52	-
B2512.5	B25	12,5-12,0	35,5	52	-
B2513.0	B25	13,0-12,5	35,5	52	-
B2513.5	B25	13,5-13,0	35,5	52	-
B2514.0	B25	14,0-13,5	35,5	52	-
B2514.5	B25	14,5-14,0	35,5	52	-
B2515.0	B25	15,0-14,5	35,5	52	-
B2515.5	B25	15,5-15,0	35,5	52	-
B2516.0	B25	16,0-15,5	35,5	52	-
B2516.5	B25	16,5-16,0	35,5	52	-

REF.		d <sub>1</sub> mm	D mm	L mm	 Kg
B2517.0	B25	17,0-16,5	35,5	52	-
B2517.5	B25	17,5-17,0	35,5	52	0,210
B2518.0	B25	18,0-17,5	35,5	52	-
B2518.5	B25	18,5-18,0	35,5	52	-
B2519.0	B25	19,0-18,5	35,5	52	-
B2519.5	B25	19,5-19,0	35,5	52	-
B2520.0	B25	20,0-19,5	35,5	52	-
B2520.5	B25	20,5-20,0	35,5	52	-
B2521.0	B25	21,0-20,5	35,5	52	-
B2521.5	B25	21,5-21,0	35,5	52	-
B2522.0	B25	22,0-21,5	35,5	52	-
B2522.5	B25	22,5-22,0	35,5	52	-
B2523.0	B25	23,0-22,5	35,5	52	-
B2523.5	B25	23,5-23,0	35,5	52	-
B2524.0	B25	24,0-23,5	35,5	52	-
B2524.5	B25	24,5-24,0	35,5	52	-
B2525.0	B25	25,0-24,5	35,5	52	0,130
B3204.0	B32	4,0-3,5	44,0	60	0,500
B3204.5	B32	4,5-4,0	44,0	60	-
B3205.0	B32	5,0-4,5	44,0	60	-
B3205.5	B32	5,5-5,0	44,0	60	-
B3206.0	B32	6,0-5,5	44,0	60	-
B3206.5	B32	6,5-6,0	44,0	60	-
B3207.0	B32	7,0-6,5	44,0	60	-
B3207.5	B32	7,5-7,0	44,0	60	-
B3208.0	B32	8,0-7,5	44,0	60	-
B3208.5	B32	8,5-8,0	44,0	60	-
B3209.0	B32	9,0-8,5	44,0	60	-
B3209.5	B32	9,5-9,0	44,0	60	-
B3210.0	B32	10,0-9,5	44,0	60	0,390
B3210.5	B32	10,5-10,0	44,0	60	-
B3211.0	B32	11,0-10,5	44,0	60	-
B3211.5	B32	11,5-11,0	44,0	60	-
B3212.0	B32	12,0-11,5	44,0	60	-
B3212.5	B32	12,5-12,0	44,0	60	-
B3213.0	B32	13,0-12,5	44,0	60	-
B3213.5	B32	13,5-13,0	44,0	60	-
B3214.0	B32	14,0-13,5	44,0	60	-
B3214.5	B32	14,5-14,0	44,0	60	-
B3215.0	B32	15,0-14,5	44,0	60	-
B3215.5	B32	15,5-15,0	44,0	60	-
B3216.0	B32	16,0-15,5	44,0	60	-
B3216.5	B32	16,5-16,0	44,0	60	-
B3217.0	B32	17,0-16,5	44,0	60	-
B3217.5	B32	17,5-17,0	44,0	60	-
B3218.0	B32	18,0-17,5	44,0	60	-
B3218.5	B32	18,5-18,0	44,0	60	-
B3219.0	B32	19,0-18,5	44,0	60	-
B3219.5	B32	19,5-19,0	44,0	60	-
B3220.0	B32	20,0-19,5	44,0	60	0,340
B3220.5	B32	20,5-20,0	44,0	60	-
B3221.0	B32	21,0-20,5	44,0	60	-
B3221.5	B32	21,5-21,0	44,0	60	-
B3222.0	B32	22,0-21,5	44,0	60	-
B3222.5	B32	22,5-22,0	44,0	60	-
B3223.0	B32	23,0-22,5	44,0	60	-
B3223.5	B32	23,5-23,0	44,0	60	-
B3224.0	B32	24,0-23,5	44,0	60	-
B3224.5	B32	24,5-24,0	44,0	60	-
B3225.0	B32	25,0-24,5	44,0	60	-
B3225.5	B32	25,5-25,0	44,0	60	-
B3226.0	B32	26,0-25,5	44,0	60	-
B3226.5	B32	26,5-26,0	44,0	60	-
B3227.0	B32	27,0-26,5	44,0	60	-
B3227.5	B32	27,5-27,0	44,0	60	-
B3228.0	B32	28,0-27,5	44,0	60	-
B3228.5	B32	28,5-28,0	44,0	60	-
B3229.0	B32	29,0-28,5	44,0	60	-
B3229.5	B32	29,5-29,0	44,0	60	-
B3230.0	B32	30,0-29,5	44,0	60	-
B3230.5	B32	30,5-30,0	44,0	60	-
B3231.0	B32	31,0-30,5	44,0	60	-
B3231.5	B32	31,5-31,0	44,0	60	-
B3232.0	B32	32,0-31,5	44,0	60	0,200

Run out table of Canela collets according to DIN 6499 showing the high precision of normal collets type 80.494, in comparison with others brands.

Rundlaufabelle der Spannzangen Canela nach DIN 6499. Die Tabelle zeigt die Hochgenauigkeit der normalen Spannzangen Typ 80.494 mi Vergleich mit anderen Marken.

THE CONTROL MUST BE MADE WITH A HIGH PRECISION "MASTER".

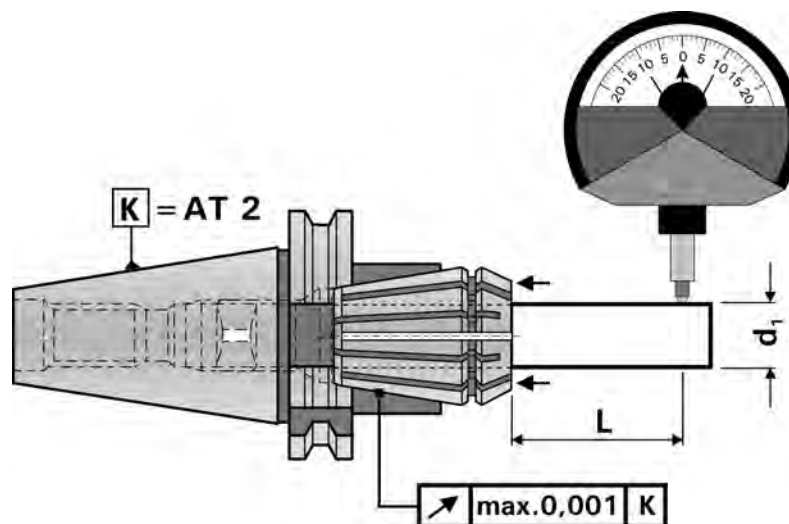

DIE KONTROLLE MUSS MIT EINER HOCHPRÄZISEN MASTER-MESSUHR GEMACHT WERDEN.





d <sub>1</sub> mm	L mm	DIN		CANELA	
		KLASSE 2 mm	KLASSE 1 mm	NORMAL mm	SUPER mm
		452XX ERXX		ERXX	
1,0 - 1,6	6	0,015	0,010	0,010	0,005
>1,6 - 3,0	10	0,015	0,010	0,010	0,005
>3,0 - 7,0	16	0,015	0,010	0,010	0,005
>7,0 -10,0	25	0,015	0,010	0,010	0,005
>10,0 -18,0	40	0,020	0,015	0,015	0,005
>18,0 -26,0	50	0,020	0,015	0,015	0,005
>26,0 -34,0	60	0,025	0,020	0,020	0,010

RECOMMENDED CLAMPING TORQUE FOR NUTS FOR DIN 6499 ER COLLETS.

EMPFOHLENES ANZUGSMOMENT FÜR SPANNMUTTER FÜR SPANNZANGEN DIN 6499 ER.

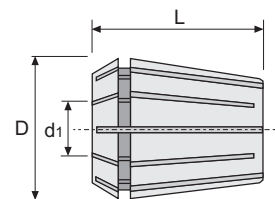

	Normal Normal	Bearings Kugellager	Mini Mini
	 <b>453 / 456</b> Max. Par Nm Max. Torque Nm Max. Anzugsmoment Nm	 <b>451</b> Max. Par Nm Max. Torque Nm Max. Anzugsmoment Nm	 <b>455</b> Max. Par Nm Max. Torque Nm Max. Anzugsmoment Nm
ER16	35 / 60	50 / 70	25 / 30
ER20	40 / 100	50 / 100	25 / 35
ER25	80 / 120	90 / 130	35 / 40
ER32	100 / 130	130 / 170	
ER40	170 / 200	220 / 220	
ER50	280 / 300	300 / 300	





REF.		d <sub>1</sub> mm	D mm	L mm	
ER1601	ER16	1,0-0,5	17	27,5	-
ER1601.5	ER16	1,5-1,0	17	27,5	-
ER1602	ER16	2,0-1,5	17	27,5	-
ER1602.5	ER16	2,5-2,0	17	27,5	-
ER1603	ER16	3,0-2,5	17	27,5	-
ER1604	ER16	4,0-3,0	17	27,5	-
ER1605	ER16	5,0-4,0	17	27,5	-
ER1606	ER16	6,0-5,0	17	27,5	-
ER1607	ER16	7,0-6,0	17	27,5	-
ER1608	ER16	8,0-7,0	17	27,5	-
ER1609	ER16	9,0-8,0	17	27,5	-
ER1610	ER16	10,0-9,0	17	27,5	0,020
ER2001	ER20	1,0-0,5	21	31,5	-
ER2001.5	ER20	1,5-1,0	21	31,5	-
ER2002	ER20	2,0-1,5	21	31,5	-
ER2002.5	ER20	2,5-2,0	21	31,5	-
ER2003	ER20	3,0-2,5	21	31,5	-
ER2004	ER20	4,0-3,0	21	31,5	-
ER2005	ER20	5,0-4,0	21	31,5	-
ER2006	ER20	6,0-5,0	21	31,5	-
ER2007	ER20	7,0-6,0	21	31,5	-
ER2008	ER20	8,0-7,0	21	31,5	-
ER2009	ER20	9,0-8,0	21	31,5	-
ER2010	ER20	10,0-9,0	21	31,5	-
ER2011	ER20	11,0-10,0	21	31,5	-
ER2012	ER20	12,0-11,0	21	31,5	-
ER2013	ER20	13,0-12,0	21	31,5	0,030
ER2501	ER25	1,0-0,5	26	34,0	-
ER2501.5	ER25	1,5-1,0	26	34,0	-
ER2502	ER25	2,0-1,5	26	34,0	-
ER2502.5	ER25	2,5-2,0	26	34,0	-
ER2503	ER25	3,0-2,5	26	34,0	-
ER2504	ER25	4,0-3,0	26	34,0	-
ER2505	ER25	5,0-4,0	26	34,0	-
ER2506	ER25	6,0-5,0	26	34,0	-
ER2507	ER25	7,0-6,0	26	34,0	-
ER2508	ER25	8,0-7,0	26	34,0	-
ER2509	ER25	9,0-8,0	26	34,0	-
ER2510	ER25	10,0-9,0	26	34,0	-
ER2511	ER25	11,0-10,0	26	34,0	-
ER2512	ER25	12,0-11,0	26	34,0	-
ER2513	ER25	13,0-12,0	26	34,0	-
ER2514	ER25	14,0-13,0	26	34,0	-
ER2515	ER25	15,0-14,0	26	34,0	-
ER2516	ER25	16,0-15,0	26	34,0	0,050



10  
DIN 208011 13  
DIN 69871-A16  
HSK DIN 69893-117  
TS ISO 26622-118  
PSC ISO 26623-120 23  
JIS B 6339-BT25  
CHIRONBORING HEADS  
BOHRKÖPFEMORSE SHANKS  
MORSE SCHAFTSCYLINDRICAL SHANKS  
ZYLINDRISCHE SCHAFTSACCESSORIES  
ZUBEHÖR

REF.		d <sub>1</sub> mm	D mm	L mm	 Kg
ER3202	ER32	2,0-1,5	33	40,0	0,140
ER3202.5	ER32	2,5-2,0	33	40,0	-
ER3203	ER32	3,0-2,5	33	40,0	-
ER3204	ER32	4,0-3,0	33	40,0	-
ER3205	ER32	5,0-4,0	33	40,0	-
ER3206	ER32	6,0-5,0	33	40,0	-
ER3207	ER32	7,0-6,0	33	40,0	-
ER3208	ER32	8,0-7,0	33	40,0	-
ER3209	ER32	9,0-8,0	33	40,0	-
ER3210	ER32	10,0-9,0	33	40,0	-
ER3211	ER32	11,0-10,0	33	40,0	-
ER3212	ER32	12,0-11,0	33	40,0	-
ER3213	ER32	13,0-12,0	33	40,0	-
ER3214	ER32	14,0-13,0	33	40,0	-
ER3215	ER32	15,0-14,0	33	40,0	-
ER3216	ER32	16,0-15,0	33	40,0	-
ER3217	ER32	17,0-16,0	33	40,0	-
ER3218	ER32	18,0-17,0	33	40,0	-
ER3219	ER32	19,0-18,0	33	40,0	-
ER3220	ER32	20,0-19,0	33	40,0	0,010
ER4003	ER40	3-2	41	46,0	0,250
ER4004	ER40	4-3	41	46,0	-
ER4005	ER40	5-4	41	46,0	-
ER4006	ER40	6-5	41	46,0	-
ER4007	ER40	7-6	41	46,0	-
ER4008	ER40	8-7	41	46,0	-
ER4009	ER40	9-8	41	46,0	-
ER4010	ER40	10-9	41	46,0	-
ER4011	ER40	11-10	41	46,0	-
ER4012	ER40	12-11	41	46,0	-
ER4013	ER40	13-12	41	46,0	-
ER4014	ER40	14-13	41	46,0	-
ER4015	ER40	15-14	41	46,0	-
ER4016	ER40	16-15	41	46,0	-
ER4017	ER40	17-16	41	46,0	-
ER4018	ER40	18-17	41	46,0	-
ER4019	ER40	19-18	41	46,0	-
ER4020	ER40	20-19	41	46,0	-
ER4021	ER40	21-20	41	46,0	-
ER4022	ER40	22-21	41	46,0	-
ER4023	ER40	23-22	41	46,0	-
ER4024	ER40	24-23	41	46,0	-
ER4025	ER40	25-24	41	46,0	-
ER4026	ER40	26-25	41	46,0	-
ER4027	ER40	27-26	41	46,0	-
ER4028	ER40	28-27	41	46,0	-
ER4029	ER40	29-28	41	46,0	-
ER4030	ER40	30-29	41	46,0	0,110
ER5006	ER50	6-4	52	60,0	-
ER5008	ER50	8-6	52	60,0	-
ER5010	ER50	10-8	52	60,0	-
ER5012	ER50	12-10	52	60,0	0,560
ER5014	ER50	14-12	52	60,0	-
ER5016	ER50	16-14	52	60,0	-
ER5018	ER50	18-16	52	60,0	-
ER5020	ER50	20-18	52	60,0	-
ER5022	ER50	22-20	52	60,0	-
ER5024	ER50	24-22	52	60,0	-
ER5026	ER50	26-24	52	60,0	-
ER5028	ER50	28-26	52	60,0	-
ER5030	ER50	30-28	52	60,0	-
ER5032	ER50	32-30	52	60,0	-
ER5034	ER50	34-32	52	60,0	0,310



<b>REF.</b>		<b>CAP</b>	<b>n°</b> 	<b>Ø</b> mm	
SET-ER16	ER16	10	10	1-2-3-4-5-6-7-8-9-10	-
SET-ER20	ER20	13	12	2-3-4-5-6-7-8-9-10-11-12-13	-
SET-ER25	ER25	16	15	2-3-4-5-6-7-8-9-10-11-12-13-14-15-16	-
SET-ER32	ER32	20	18	3-4-5-6-7-8-9-10-11-12-13-14-15-16-17-18-19-20	-
SET-ER40	ER40	26	23	4-5-6-7-8-9-10-11-12-13-14-15-16-17-18-19-20-21-22-23-24-25-26	-

## COLLETS DIN 6499 - FORM Canela (ER)

with square locking drive and tension length-adjustment

## SPANNZANGEN DIN 6499 - FORM Canela (ER)



mit vierkantigem Antrieb und Zuglängenausgleich

DIN 6499-Canela

ERBXX

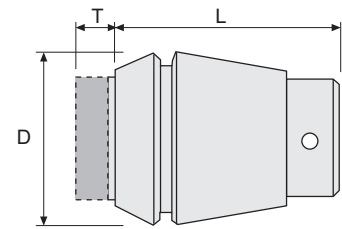
CANELA



REF.		DIN d x a mm	D mm	L mm	T mm	
ERB1601	ER16	2,5 x 2,1	17	27	7	-
ERB1602	ER16	2,8 x 2,1	17	27	7	-
ERB1603	ER16	3,5 x 2,7	17	27	7	-
ERB1604	ER16	4,0 x 3,0	17	27	7	-
ERB1605	ER16	4,5 x 3,4	17	27	7	-
ERB1606	ER16	5,5 x 4,3	17	27	7	-
ERB1607	ER16	6,0 x 4,9	17	27	7	0,030
ERB2001	ER20	2,5 x 2,1	21	31	7	-
ERB2002	ER20	2,8 x 2,1	21	31	7	-
ERB2003	ER20	3,5 x 2,7	21	31	7	0,050
ERB2004	ER20	4,0 x 3,0	21	31	7	-
ERB2005	ER20	4,5 x 3,4	21	31	7	-
ERB2006	ER20	5,5 x 4,3	21	31	7	-
ERB2007	ER20	6,0 x 4,9	21	31	7	-
ERB2008	ER20	7,0 x 5,5	21	31	7	-
ERB2501	ER25	2,5 x 2,1	26	34	8	-
ERB2502	ER25	2,8 x 2,1	26	34	8	-
ERB2503	ER25	3,5 x 2,7	26	34	8	-
ERB2504	ER25	4,0 x 3,0	26	34	8	-
ERB2505	ER25	4,5 x 3,4	26	34	8	-
ERB2506	ER25	5,5 x 4,3	26	34	8	-
ERB2507	ER25	6,0 x 4,9	26	34	8	-
ERB2508	ER25	7,0 x 5,5	26	34	8	-
ERB2509	ER25	8,0 x 6,2	26	34	8	-
ERB2510	ER25	9,0 x 7,0	26	34	8	-
ERB3205	ER32	4,5 x 3,4	33	43	10	-
ERB3206	ER32	5,5 x 4,3	33	43	10	-
ERB3207	ER32	6,0 x 4,9	33	43	10	-
ERB3208	ER32	7,0 x 5,5	33	43	10	-
ERB3209	ER32	8,0 x 6,2	33	43	10	0,160
ERB3210	ER32	9,0 x 7,0	33	43	10	-
ERB3211	ER32	10,0 x 8,0	33	43	10	-
ERB3212	ER32	11,0 x 9,0	33	43	10	-
ERB3213	ER32	12,0 x 9,0	33	43	10	-
ERB4007	ER40	6,0 x 4,9	41	54	13	-
ERB4008	ER40	7,0 x 5,5	41	54	13	-
ERB4009	ER40	8,0 x 6,2	41	54	13	-
ERB4010	ER40	9,0 x 7,0	41	54	13	-
ERB4011	ER40	10,0 x 8,0	41	54	13	-
ERB4012	ER40	11,0 x 9,0	41	54	13	-
ERB4013	ER40	12,0 x 9,0	41	54	13	-
ERB4014	ER40	14,0 x 11,0	41	54	13	-
ERB4015	ER40	16,0 x 12,0	41	54	13	0,270



## SEALED COLLETS DIN 6499 (ER)

for tools with cylindrical shank DIN 1835-A and coolant channel

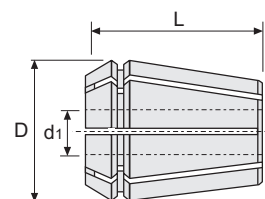

## ABGEDICHTETE SPANNZANGEN DIN 6499 (ER)

für Werkzeuge mit Zylinderschaft DIN 1835-A und Innenkühlung





REF.		D mm	L mm	d <sub>1</sub> mm	
ERC1604	ER16	17	27,5	4	-
ERC1605	ER16	17	27,5	5	-
ERC1606	ER16	17	27,5	6	-
ERC1607	ER16	17	27,5	7	-
ERC1608	ER16	17	27,5	8	-
ERC1609	ER16	17	27,5	9	-
ERC1610	ER16	17	27,5	10	-
ERC2004	ER20	21	31,5	4	-
ERC2005	ER20	21	31,5	5	-
ERC2006	ER20	21	31,5	6	-
ERC2007	ER20	21	31,5	7	-
ERC2008	ER20	21	31,5	8	-
ERC2009	ER20	21	31,5	9	-
ERC2010	ER20	21	31,5	10	-
ERC2011	ER20	21	31,5	11	-
ERC2012	ER20	21	31,5	12	-
ERC2013	ER20	21	31,5	13	-
ERC2504	ER25	26	34,0	4	-
ERC2505	ER25	26	34,0	5	-
ERC2506	ER25	26	34,0	6	-
ERC2507	ER25	26	34,0	7	-
ERC2508	ER25	26	34,0	8	-
ERC2509	ER25	26	34,0	9	-
ERC2510	ER25	26	34,0	10	-
ERC2511	ER25	26	34,0	11	-
ERC2512	ER25	26	34,0	12	-
ERC2513	ER25	26	34,0	13	-
ERC2514	ER25	26	34,0	14	-
ERC2515	ER25	26	34,0	15	-
ERC2516	ER25	26	34,0	16	-
ERC3204	ER32	33	40,0	4	-
ERC3205	ER32	33	40,0	5	-
ERC3206	ER32	33	40,0	6	-
ERC3207	ER32	33	40,0	7	-
ERC3208	ER32	33	40,0	8	-
ERC3209	ER32	33	40,0	9	-
ERC3210	ER32	33	40,0	10	-
ERC3211	ER32	33	40,0	11	-
ERC3212	ER32	33	40,0	12	-
ERC3213	ER32	33	40,0	13	-
ERC3214	ER32	33	40,0	14	-
ERC3215	ER32	33	40,0	15	-
ERC3216	ER32	33	40,0	16	-
ERC3217	ER32	33	40,0	17	-
ERC3218	ER32	33	40,0	18	-
ERC3219	ER32	33	40,0	19	-
ERC3220	ER32	33	40,0	20	-

10  
DIN 208011 13  
DIN 69871-A16  
HSK DIN 69893-117  
TS ISO 26622-118  
PSC ISO 26623-120 23  
JIS B 6339-BT25  
CHIRONBORING HEADS  
BOHRKÖPFEMORSE SHANKS  
MORSE SCHAFTECYLINDRICAL SHANKS  
ZYLINDRISCHE SCHAFTEACCESSORIES  
ZUBEHÖR

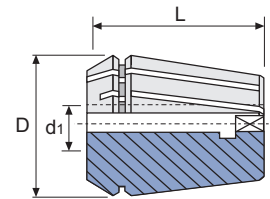
REF.		D mm	L mm	d <sub>1</sub> mm	
ERC4004	ER40	41	46,0	4	-
ERC4005	ER40	41	46,0	5	-
ERC4006	ER40	41	46,0	6	-
ERC4007	ER40	41	46,0	7	-
ERC4008	ER40	41	46,0	8	-
ERC4009	ER40	41	46,0	9	-
ERC4010	ER40	41	46,0	10	-
ERC4011	ER40	41	46,0	11	-
ERC4012	ER40	41	46,0	12	-
ERC4013	ER40	41	46,0	13	-
ERC4014	ER40	41	46,0	14	-
ERC4015	ER40	41	46,0	15	-
ERC4016	ER40	41	46,0	16	-
ERC4017	ER40	41	46,0	17	-
ERC4018	ER40	41	46,0	18	-
ERC4019	ER40	41	46,0	19	-
ERC4020	ER40	41	46,0	20	-
ERC4021	ER40	41	46,0	21	-
ERC4022	ER40	41	46,0	22	-
ERC4023	ER40	41	46,0	23	-
ERC4024	ER40	41	46,0	24	-
ERC4025	ER40	41	46,0	25	-
ERC4026	ER40	41	46,0	26	-
ERC5012	ER50	52	50,0	12	-
ERC5014	ER50	52	50,0	14	-
ERC5016	ER50	52	50,0	16	-
ERC5018	ER50	52	50,0	18	-
ERC5020	ER50	52	50,0	20	-
ERC5022	ER50	52	50,0	22	-
ERC5024	ER50	52	50,0	24	-
ERC5026	ER50	52	50,0	26	-
ERC5028	ER50	52	50,0	28	-
ERC5030	ER50	52	50,0	30	-
ERC5032	ER50	52	50,0	32	-
ERC5034	ER50	52	50,0	34	-



REF.		d <sub>1</sub> mm	D mm	L mm	
ERT1605	ER16	4,5 x 3,4	17	27,5	-
ERT1606	ER16	5,5 x 4,3	17	27,5	-
ERT1607	ER16	6,0 x 4,9	17	27,5	-
ERT1608	ER16	7,0 x 5,5	17	27,5	-
ERT2005	ER20	4,5 x 3,4	21	31,5	-
ERT2006	ER20	5,5 x 4,3	21	31,5	-
ERT2007	ER20	6,0 x 4,9	21	31,5	-
ERT2008	ER20	7,0 x 5,5	21	31,5	-
ERT2009	ER20	8,0 x 6,2	21	31,5	-
ERT2010	ER20	9,0 x 7,0	21	31,5	-
ERT2011	ER20	10,0 x 8,0	21	31,5	-
ERT2505	ER25	4,5 x 3,4	26	34,0	-
ERT2506	ER25	5,5 x 4,3	26	34,0	-
ERT2507	ER25	6,0 x 4,9	26	34,0	-
ERT2508	ER25	7,0 x 5,5	26	34,0	-
ERT2509	ER25	8,0 x 6,2	26	34,0	-
ERT2510	ER25	9,0 x 7,0	26	34,0	-
ERT2511	ER25	10,0 x 8,0	26	34,0	-
ERT2512	ER25	11,0 x 9,0	26	34,0	-
ERT2513	ER25	12,0 x 9,0	26	34,0	-
ERT3205	ER32	4,5 x 3,4	33	40,0	-
ERT3206	ER32	5,5 x 4,3	33	40,0	-
ERT3207	ER32	6,0 x 4,9	33	40,0	-
ERT3208	ER32	7,0 x 5,5	33	40,0	-
ERT3209	ER32	8,0 x 6,2	33	40,0	-
ERT3210	ER32	9,0 x 7,0	33	40,0	-
ERT3211	ER32	10,0 x 8,0	33	40,0	-
ERT3212	ER32	11,0 x 9,0	33	40,0	-
ERT3213	ER32	12,0 x 9,0	33	40,0	-
ERT3214	ER32	14,0 x 11,0	33	40,0	-
ERT3215	ER32	16,0 x 12,0	33	40,0	-
ERT4008	ER40	7,0 x 5,5	41	46,0	-
ERT4009	ER40	8,0 x 6,2	41	46,0	-
ERT4010	ER40	9,0 x 7,0	41	46,0	-
ERT4011	ER40	10,0 x 8,0	41	46,0	-
ERT4012	ER40	11,0 x 9,0	41	46,0	-
ERT4013	ER40	12,0 x 9,0	41	46,0	-
ERT4014	ER40	14,0 x 11,0	41	46,0	-
ERT4015	ER40	16,0 x 12,0	41	46,0	-
ERT4016	ER40	18,0 x 14,5	41	46,0	-
ERT4017	ER40	20,0 x 16,0	41	46,0	-
ERT5013	ER50	12,0 x 9,0	52	60,0	-
ERT5014	ER50	14,0 x 11,0	52	60,0	-
ERT5015	ER50	16,0 x 12,0	52	60,0	-
ERT5016	ER50	18,0 x 14,5	52	60,0	-
ERT5017	ER50	20,0 x 16,0	52	60,0	-
ERT5018	ER50	22,0 x 18,0	52	60,0	-
ERT5019	ER50	25,0 x 20,0	52	60,0	-
ERT5020	ER50	28,0 x 22,0	52	60,0	-
ERT5021	ER50	32,0 x 24,0	52	60,0	-

CANELA

WRENCHES

SCHLÜSSEL

35.294  
xx.295

REF.	CAP mm	kg
50008	0 - 8	-
50010	0-10	-
50013	0-13	-
50016	3-16	-



XX. { 353



REF.	CAP mm	kg
50116	16	-
50125	25	-
50132	32	-
50140	40	-

XX. { 453  
610

REF.	ER	CAP mm	kg
50216	16	10	-
50220	20	13	-
50225	25	16	-
50232	32	20	-
50240	40	30	-
50250	50	34	-





xx.455



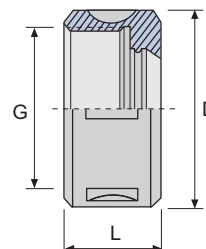

REF.	ER	CAP mm	kg
50907	07	-	-
50908	08	-	-
50916	16	10	-
50920	20	13	-
50925	25	16	-

10  
DIN 208011 13  
DIN 69871-A16  
HSK DIN 69893-117  
TS ISO 26622-118  
PSC ISO 26623-120 23  
JIS B 6339-BT25  
CHIRONBORING HEADS  
BOHRKÖPFEMORSE SHANKS  
MORSE SCHAFTCYLINDRICAL SHANKS  
ZYLINDRISCHE SCHAFTACCESSORIES  
ZUBEHÖR

STANDARD  
STANDARD

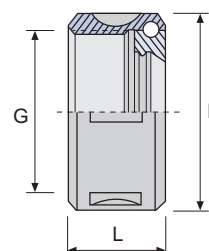
REF.	 $d_{1 \max}$ mm	D mm	L mm	G	 Kg
43316	16	43	24,0	M 32 x 1,5	-
43325	25	60	30,0	M 48 x 2,0	-
43332	32	72	33,5	M 60 x 2,5	-

BALL BEARING NUT  
KUGELLAGER-MUTTER

REF.	 $d_{1 \max}$ mm	D mm	L mm	G	 Kg
43116	16	43	24,0	M 32 x 1,5	-
43125	25	60	30,0	M 48 x 2,0	-
43132	32	72	33,5	M 60 x 2,5	-



10  
DIN 208011 13  
DIN 69871-A16  
HSK DIN 69893-117  
TS ISO 26622-118  
PSC ISO 26623-120 23  
JIS B 6339-BT25  
CHIRONBORING HEADS  
BOHRKÖPFEMORSE SHANKS  
MORSE SCHÄPFTECYLINDRICAL SHANKS  
ZYLINDRISCHE SCHÄPFTEACCESSORIES  
ZUBEHÖR**CANELA**



NUT FOR COLLET CHUCKS DIN 6499 (ER)

SPANNMUTTER FÜR SPANNZANGEN DIN 6499 (ER)

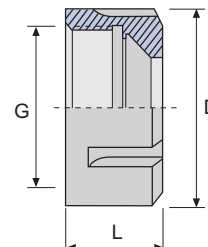

DIN 6499 D-F

453XX/451XX

FORM F  
STANDARD  
STANDARD

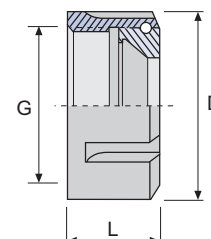
REF.		d <sub>1</sub> max mm	D mm	L mm	G	
45316	ER16	10	32	17,5	M 22 x 1,5	-
45320	ER20	13	35	19,0	M 25 x 1,5	-
45325	ER25	16	42	20,0	M 32 x 1,5	-
45332	ER32	20	50	22,5	M 40 x 1,5	-
45340	ER40	26	63	25,5	M 50 x 1,5	-
45350	ER50	34	78	35,5	M 64 x 2,0	-



FORM E  
BALL BEARING NUT  
KUGELLAGER-MUTTER

REF.		d <sub>1</sub> max mm	D mm	L mm	G	
45116	ER16	10	29	19,5	M 22 x 1,5	-
45120	ER20	13	34	21,0	M 25 x 1,5	-
45125	ER25	16	42	22,7	M 32 x 1,5	-
45132	ER32	20	50	26,5	M 40 x 1,5	-
45140	ER40	26	63	29,8	M 50 x 1,5	-
45150	ER50	34	78	40,0	M 64 x 2,0	-

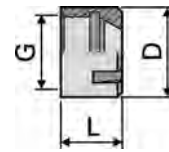

FORM MINI





REF.		d <sub>1 max</sub> mm	D mm	L mm	G	
45507	ER07	10	22	18	M 19 x 1	-
45516	ER16	13	28	19	M 24 x 1	-
45520	ER20	16	35	20	M 30 x 1	-
45525	ER25	-	35	-	M 30 x 1	-



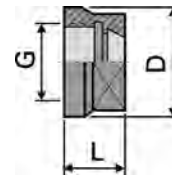

FORM D

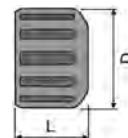

REF.		d <sub>1 max</sub> mm	D mm	L mm	G	
45616	ER16	10	28	17,5	M 22 x 1,5	-
45620	ER20	13	34	19,0	M 25 x 1,5	-

ESPECIAL 457  
SONDERAUSFÜHRUNG 457

REF.		d <sub>1 max</sub> mm	D mm	L mm	G	
45732	ER32	20	54	40	M 45 x 1,5	-
45740	ER40	30	65	50	M 56 x 2,0	-

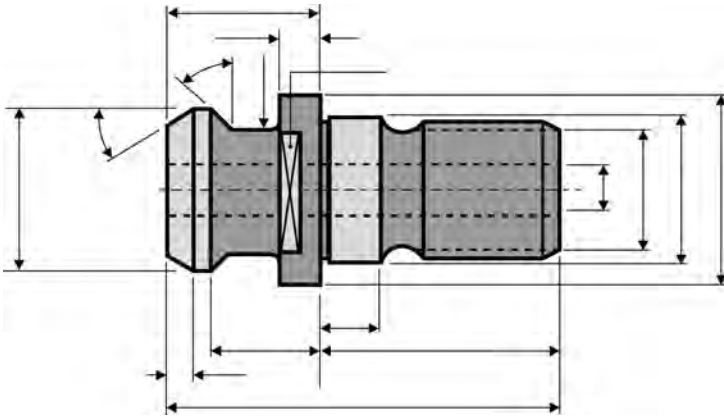

- For enquiries: Fill up sizes and send us drawing.

- Für Anfragen bitte die Abmessungen angeben und uns eine Zeichnung schicken.

10  
DIN 2080

11 13  
DIN 69871-A

16  
HSK DIN 69893-1

17  
TS ISO 26622-1

18  
PSC ISO 26623-1

20 23  
JIS B 6339-BT

25  
CHIRON

BORING HEADS  
BOHRKÖPFE

MORSE SHANKS  
MORSE SCHAFTE

CYLINDRICAL SHANKS  
ZYLINDRISCHE SCHAFTE

ACCESSORIES  
ZUBEHÖR

## DIN - ISO PULL STUDS - ANZUGSBOLZEN 91..



DIN 69872-A	REF.	K ISO	G mm	d mm	d <sub>1</sub> mm	L mm	l <sub>1</sub> mm	kg
	91103 *	30	M 12	13	13	44	24	0,040
	91104	40	M 16	17	19	54	26	-
	91105	50	M 24	25	28	74	34	0,210



\* Without central hole / \* Ohne zentralem Loch

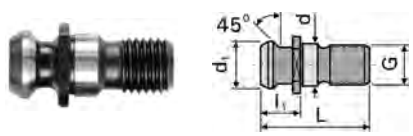

DIN 69872-B	REF.	K ISO	G mm	d mm	d <sub>1</sub> mm	L mm	l <sub>1</sub> mm	kg
	91154	40	M 16	17	19	54	26	-
	91155	50	M 24	25	28	74	34	-

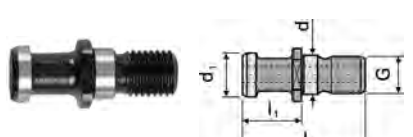

±DIN 69872-B	REF.	K ISO	G mm	d mm	d <sub>1</sub> mm	L mm	l <sub>1</sub> mm	kg
	91164	40	M 16	17	19	54	26	0,100
	91165	50	M 24	25	28	74	34	0,290

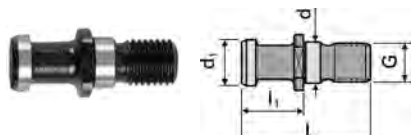

ISO 7388/2-B	REF.	K ISO	G mm	d mm	d <sub>1</sub> mm	L mm	l <sub>1</sub> mm	kg
	91304	40	M 16	17	18,95	44,5	16,40	0,070
	91305	50	M 24	25	29,10	65,5	25,55	0,200

± ISO 7388/2-B		REF.	K	G	d	d <sub>1</sub>	L	l <sub>1</sub>	
			ISO	mm	mm	mm	mm	mm	mm
		91114	40	M 16	17	18,95	44,5	16,40	-
		91115	50	M 24	25	29,10	65,5	25,55	-

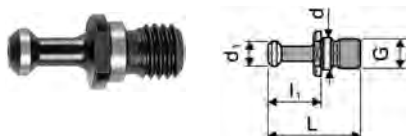
ISO 7388/2-A		REF.	K	G	d	d <sub>1</sub>	L	l <sub>1</sub>	
			ISO	mm	mm	mm	mm	mm	mm
		91354	40	M 16	17	19	54	26	-
		91355	50	M 24	25	28	74	34	-

± ISO 7388/2-A		REF.	K	G	d	d <sub>1</sub>	L	l <sub>1</sub>	
			ISO	mm	mm	mm	mm	mm	mm
		91263	30	M 12	13	12	44	24	-
		91264	40	M 16	17	19	54	26	0,090
		91265	50	M 24	25	28	74	34	0,280

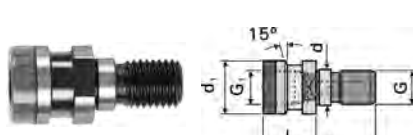
CHIRON		REF.	K	G	d	d <sub>1</sub>	L	l <sub>1</sub>	
			ISO	mm	mm	mm	mm	mm	mm
		92503	30	M 12	13	10	36	20	-

MAHO - OTT		REF.	K	G	G <sub>1</sub>	d	d <sub>1</sub>	L	l <sub>1</sub>	
			ISO	mm	mm	mm	mm	mm	mm	mm
		91004	40	M 16	M 16	17	25,00	53	25	-
		91014	50	M 16	M 16	17	25,00	56	28	-
		91005	50	M 24	M 24	25	39,29	68	25	-

Accessory to mount the DIN-69872-A and JIS 6339-BT to DIN 20820 machines  
Ersatzteil um die DIN-69872-A und die JIS 6339-BT auf Maschinen DIN 20820

## BT - TYPE I

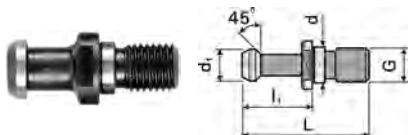

REF.	K ISO	G mm	d mm	d <sub>1</sub> mm	L mm	l <sub>1</sub> mm	
92003	30	M 12	12,5	11	43	23	-
92004	40	M 16	17,0	15	60	35	-
92005	50	M 24	25,0	23	85	45	-
92304	40	M 16	17,0	15	60	35	-
92305	50	M 24	25,0	23	85	45	-

With central hole / Mit zentralem Loch

## BT - TYPE II

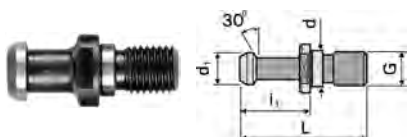

REF.	K ISO	G mm	d mm	d <sub>1</sub> mm	L mm	l <sub>1</sub> mm	
92013	30	M 12	12,5	11	43	23	-
92014	40	M 16	17,0	15	60	35	-
92015	50	M 24	25,0	23	85	45	-
92314	40	M 16	17,0	15	60	35	-
92315	50	M 24	25,0	23	85	45	-

With central hole / Mit zentralem Loch

## BT - TYPE III

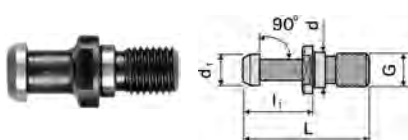

REF.	K ISO	G mm	d mm	d <sub>1</sub> mm	L mm	l <sub>1</sub> mm	
92024	40	M 16	17	15	60	35	-
92025	50	M 24	25	23	85	45	-
92324	40	M 16	17	15	60	35	-
92325	50	M 24	25	23	85	45	-

With central hole / Mit zentralem Loch

## SPECIALS

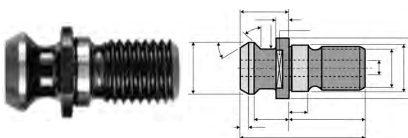

REF.	K ISO	G mm	d mm	d <sub>1</sub> mm	L mm	l <sub>1</sub> mm	Tipo Type	
9CA40	40	M 16	17	18,79	41,25	16,25	MAZAK	-
9CA41	40	M 16	17	18,79	44,10	19,10	MAZAK	-
9CO50	50	M 24	-	20,00	76,00	36,00	CORREA	-
9MT40	40	M 16	17	19,00	54,00	29,00	MATSURA	-
9OK35	35						KITAMURA	-
9CI40	40						CINCINNATI	-
9ZA50	50						ZAYER	0,340

With central hole / Mit zentralem Loch

## MOUNTING ASSEMBLY FOR TOOLHOLDERS

all sizes useful for: DIN 2080, DIN 69871/A, MAS BT, HSK, TS AND PSC

## MONTAGEVORRICHTUNG FÜR WERKZEUGHALTER

Alle Größe sind für DIN 2080, DIN 69871/A, MAS BT, HSK, TS und PSC verwendbar

**02.70/80**  
**02.71/81**

**02.70/80**



Can be tightened on bench or clamp.  
Useful for mounting and dismantling  
of the tools in any toolholder.

**02.71/81**



Es kann auf einer Bank oder mit einem  
Schraubstock befestigt werden. Nützlich,  
um die Werkzeuge in jedem Werkzeughalter  
zu montieren und demontieren.

Combined stainless / blackened  
Kombiniert rostfrei / brüniert



REF.	DIN 2080	DIN 69871/A	MAS BT	HSK	PSC	TS	kg
02.30.70	30	30	X	50	C5	50	-
02.30.80	X	X	30	X	X	X	-
02.40.70	40	40	40	63	C6	63	2,765
02.50.70	50	50	X	100	X	X	-
02.50.80	X	X	50	X	X	X	-

100% stainless  
100% rostfrei



REF.	DIN 2080	DIN 69871/A	MAS BT	HSK	PSC	TS	kg
02.30.71	30	30	X	50	C5	50	-
02.30.81	X	X	30	X	X	X	-
02.40.71	40	40	40	63	C6	63	2,765
02.50.71	50	50	X	100	X	X	-
02.50.81	X	X	50	X	X	X	-

## 10 - DIN 2080

Ref.	Page / Seite
10.160	A.02
10.165	A.03
10.180	A.04
10.210	A.05
10.215	A.06
10.216	A.07
10.220	A.08
10.225	A.09
10.290	A.10
10.295	A.11
10.296	A.12
10.300	A.13
10.302	A.14
10.353	A.15
10.453	A.16
10.457	A.18
10.470	A.19
10.610	A.20
10.620	A.21
10.630	A.22
SET	A.17

## 16 - HSK DIN 69893-1

Ref.	Page / Seite
16.160	C.02
16.180	C.03
16.210	C.04
16.215	C.05
16.296	C.06
16.300	C.07
16.305	C.08
16.315	C.09
16.453	C.10
16.455	C.11
16.470	C.12
16.999	C.12

## 20/23 - JIS B 6339-BT

Ref.	Page / Seite
20.160	F.03
20.165	F.07
20.180	F.08
20.210	F.09
20.215	F.11
20.216	F.13
20.225	F.14
20.226	F.14
20.290	F.15
20.295	F.16
20.296	F.17
20.300	F.20
20.302	F.22
20.305	F.24
20.353	F.29
20.400	F.30
20.453	F.32
20.455	F.35
20.457	F.36
20.470	F.38
20.512	F.39
20.610	F.40
20.620	F.42
20.630	F.43
20.999	F.44
A20.160	F.05
A20.160	F.06
A20.315	F.28
23.160	F.04
23.210	F.10
23.215	F.12
23.296	F.18
23.297	F.19
23.300	F.21
23.302	F.23
23.306	F.25
23.307	F.26
23.315	F.27
23.453	F.34
23.457	F.37
23.610	F.41
SET	F.33
SET-C20/32	F.31

## 11/13 - DIN 69871-A

Ref.	Page / Seite
11.160	B.03
11.165	B.07
11.180	B.08
11.210	B.09
11.215	B.11
11.216	B.13
11.225	B.14
11.226	B.14
11.290	B.15
11.295	B.16
11.296	B.17
11.300	B.20
11.302	B.22
11.305	B.24
11.353	B.29
11.400	B.30
11.453	B.32
11.455	B.35
11.457	B.36
11.470	B.38
11.512	B.39
11.610	B.40
11.620	B.42
11.630	B.43
11.999	B.44
A11.160	B.05
A11.160	B.06
A11.315	B.28
13.160	B.04
13.210	B.10
13.215	B.12
13.296	B.18
13.297	B.19
13.300	B.21
13.302	B.23
13.306	B.25
13.307	B.26
13.315	B.27
13.453	B.34
13.457	B.37
13.610	B.41
SET	B.33
SET-C20/32	B.31

## 17 - TS ISO 26622-1

Ref.	Page / Seite
17.160	D.02
17.215	D.03
17.296	D.04
17.306	D.05
17.315	D.06
17.453	D.07
17.470	D.08
17.500	D.09
17.510	D.10
17.520	D.11
17.530	D.12
17.540	D.13
17.550	D.14
17.620	D.15
17.999	D.16

## 18 - PSC ISO 26623-1

Ref.	Page / Seite
18.160	E.02
18.180	E.03
18.215	E.04
18.296	E.05
18.306	E.06
18.315	E.07
18.400	E.08
18.406	E.09
18.453	E.10
18.455	E.11
18.470	E.12
18.500	E.13
18.510	E.14
18.520	E.15
18.530	E.16
18.540	E.17
18.550	E.18
18.620	E.19
18.999	E.20

## 25 - CHIRON

Ref.	Page / Seite
25.160	G.02
25.180	G.03
25.210	G.04
25.215	G.05
25.290	G.06
25.295	G.07
25.300	G.08
25.302	G.09
25.305	G.10
25.353	G.11
25.453	G.12
25.470	G.13
25.610	G.14

**BORING HEADS / BOHRKÖPFE**

Ref.	Page / Seite
10.700	H.11
11.700	H.12
16.700	H.13
17.700	H.14
18.700	H.15
20.700	H.16
60.62/64	H.17
60.12/24	H.17
63.12/28	H.05
63.36/60	H.06
64.12/28	H.07
64.36/60	H.08
66.20/28	H.09
66.36/60	H.10
97.15/24	H.02
SCLC	H.03
SET-97 SCLC	H.18
SET-97 STFC	H.18
STFC	H.04

**MORSE SHANKS  
MORSE SCHÄFTE**

Ref.	Page / Seite
30.315	I.02
36.453	I.03
37.215	I.04
37.290	I.05
37.295	I.06
37.296	I.07

**CYLINDRICAL SHANKS  
ZYLINDRISCHE SCHÄFTE**

Ref.	Page / Seite
06.315	J.02
06.315	J.03
40.295	J.04
40.296	J.05
40.315	J.07
40.453	J.08
40.455	J.09
42.300	J.11
42.311	J.12
42.454	J.13
42.610	J.14
42.620	J.15
43.296	J.06
43.457	J.10
SET-42.454	J.13

**ACCESSORIES / ZUBEHÖR**

Ref.	Page / Seite
02.70/80	K.27
02.71/81	K.27
431XX	K.21
433XX	K.21
451XX	K.22
453XX	K.22
455XX	K.23
456XX	K.23
457XX	K.23
50XX	K.20
7_0XX	K.06
7_0XX	K.07
91..	K.24
92..	K.26
BXX	K.10
ERXX	K.13
ERBXX	K.16
ERCXX	K.17
ERTXX	K.19
MH	K.05
MK	K.04
MP	K.03
MU	K.02
SET-ER	K.15



### Conditions of sale:

All sales are made in accordance with our standard conditions of sale, current at the time orders are accepted. Specifications and prices subject to change without notice.

### Product warranty:

Canela will repair or replace any of its products, which in its judgement, are found to be defective in material of workmanship. All claims must be made in writing within thirty days after receipt of product. No claims for labor or damages will be allowed. In no event shall Canela be liable for consequential or special damages of any kind.

### Special tool quotation:

Orders for special tools must be confirmed in writing before manufacturing can begin. Special items and non-stock standard items cannot be cancelled or returned for exchange or credit.

### Delivery terms:

Badalona. Full transportation costs will be charged to the buyer. Specify shipment to be made by other than regular means of transportation.

### Claims:

Claims for loss in transit must be made against the transportation company. The foregoing shall constitute the sole and exclusive remedies of the customer and are in lieu of all other warranties, expressed, implied or statutory, including but not limited to any implied warranty of merchantability or fitness.

### Returns:

No merchandise will be accepted for return after 30 days of shipment. All returns must be pre-paid and must be accompanied by our Return Goods Authorization (RGA) number. This number must appear on the outside of the box. Merchandise must be received in good condition or will be refused.

This catalogue contains information and specifications concerning cutting tools sold by Canela. Although some of the cutting tools made from carbides are very tough and resist breakage, most are brittle and special safety precautions are required when using them.

Small fragment and chips may be thrown from a cutting tool when a fracture occurs. Since these fragments or chips are thrown at very high speeds and are very hot, contact with the skin or eyes could cause severe injury. Also, the grinding of these cutting tools will produce fine carbide and cobalt or nickel dust which may be harmful to the lungs.

Listed below are some suggestions on how to minimize the potential for injury while using cutting tools.

For more information about the product hazards and safety precautions that must be taken to minimize the possibility of injury while using cutting tools, please call your Canela Sales Engineer. Canela has no control over use of these cutting tools. The user must determine the suitability of these tools in its particular application.

**WARNING: Very hot chip fragments may be thrown from cutting tools at very high speeds. These chips can cause severe burns, cuts or punctures to the skin, or damage to the eyes. The following are some of the safety precautions that must be followed by operators and observers while using cutting tools:**

1. Make sure that the insert size and shape are adequate for use to which it is being put.
2. Chip control is necessary to prevent a continuous chip catching in the workpiece.
3. Chips are very hot and have sharp edges and should not be moved by hand.
4. Turn off the machine whenever chips are removed or when the cutting tools are changed.
5. Do not use air hoses to blow chips away from the machine.
6. To prevent tool breakage use the correct size toolholder.
7. Make sure that the overhang on the toolholder is as short as possible. Too much overhang can result in chatter and tool breakage.
8. To prevent the workpiece from coming loose during use, be sure the workpiece is tight and secure in its holder.
9. Overloading of tungsten carbide cutting tools may cause fractures of these tools.
10. A slug may be ejected at high speeds during drilling.

To protect the operator and observer from possible flying objects which could result in severe injury, the following protective devices should be worn or used while using cutting tools:

1. Wear hard hats.
2. Wear safety glasses with side shields.
3. Wear closed shoes with steel toes.
4. Keep protective enclosure on machine in place during operation.

**WARNING: Grinding or finishing carbide produces fine carbide and cobalt or nickel dust. This dust may cause injury to the lungs. Operators and observers must take the following safety precautions to minimize the possibility of such injury:**

1. Use with adequate ventilation.
2. Maintain the dust or mist level below recommended levels.
3. Avoid breathing dust or mist. If not possible, wear appropriate respirators, particularly when grinding tungsten carbide.
4. Minimize prolonged skin contact.
5. Wash hands thoroughly after handling.

**WARNING: Use of cutting fluids and work materials create hazards. Be careful at all times.**

1. Keep the cutting fluid clean so no particles can be carried back across the workpiece and possibly scratch it.
2. Cutting fluids may catch on fire when exposed to high temperatures generated during cutting.
3. Work materials such as aluminium, magnesium, uranium and titanium are flammable and could catch on fire.
4. Cutting fluids should be treated or replaced to reduce bacterial levels which may cause illness.

### -WARNING-

Speeds, Feeds and Grade information within this catalogue are for reference only. If the operator does not feel safe using our speeds, feeds and grades, then the operator should use what is comfortable to him or her. Canela is not responsible for any damage or injury that occurs using the speeds, feeds and grades information within catalogue.

**Conditions, terms, and prices are subject to change without notice. Any typographical or other error in this catalogue is subject to correction.**

### **Verkaufsbedingungen:**

Alle Verkäufe werden in Übereinstimmung mit unseren Standard-Lieferbedingungen gemacht, die gültig waren wenn die Bestellung akzeptiert worden sind. Spezifizierungen und Preise können ohne Benachrichtigung geändert werden.

### **Produktgarantie:**

Firma Canela wird die Produkte ersetzen oder reparieren, die ihrer Meinung nach, einen Defekt der Materialien oder der Herstellung aufweisen. Alle Ansprüche müssen innerhalb von 30 Tagen nach Erhalt des Produktes erhoben werden. In keinem Fall wird die Firma Canela für Folgeschäden jeder Art verantwortlich sein.

### **Angebote für Sonderwerkzeuge:**

Die Bestellungen von Sonderzeugen müssen schriftlich bestätigt werden, bevor die Herstellung beginnen kann. Sonderwerkzeuge und nicht auf Lager liegende Standardwerkzeuge können nicht storniert oder zurückgegeben werden. Werden Sonderwerkzeuge in Auftrag gegeben, so darf die Bestellmenge um ca. 10%, mindestens jedoch um 2 Stück, über-oder unterschritten werden. Berechnet wird die Liefermenge.

### **Lieferbedingungen:**

Badalona. Alle Transportkosten sind vom Käufer zu bezahlen. Der Käufer muss den Verkäufer darüber informieren, wenn er eine Sendung durch eine andere Transportfirma beauftragt hat.

### **Ansprüche:**

Ansprüche auf den Verlust während der Fahrt, müssen gegen die Transportgesellschaft erhoben werden. Das Vorstehende soll die alleinigen und exklusiven Hilfsmittel des Kunden einsetzen und wird anstatt aller anderen Garantien (ausgedrückt, einbezogen oder gesetzlich, einschließlich aber nicht beschränkt auf jede implizierte Garantie der Marktfähigkeit oder Eignung) angewendet.

### **Rückgaben:**

30 Tage nach Versanddatum werden keine Warenrückgaben mehr akzeptiert. Alle Rücksendungen müssen frei Haus geschickt werden. Die Waren müssen im guten Zustand in unserem Hause eingehen, ansonsten wird die Annahme verweigert. Sonderanfertigungen werden grundsätzlich nicht zurückgenommen. Warengutschriften: Soweit eine Warengutschrift gewährt wird, ergibt sich die Höhe der Gutschrift aus dem Betrag der Originalrechnung / Warenwert.

Dieser Katalog enthält Informationen und Spezifizierungen bezüglich Schneidwerkzeugen, die durch die Firma Canela verkauft werden.

Obwohl einige der aus Hartmetall hergestellten Schneidwerkzeuge sehr zäh sind und einem Bruch widerstehen, sind die meisten spröde, und spezielle Sicherheitsvorsichtsmaßnahmen sind erforderlich, wenn man sie verwendet.

Bruchstücke oder Späne können sehr heiß sein und dadurch zu Verletzungen führen, wenn sie mit der Hand oder den Augen in Kontakt kommen. Außerdem wird beim Schleifen dieser Schneidwerkzeuge feiner Karbid- und Kobalt- oder Nickel-Staub erzeugt, der für die Lungen schädlich sein kann. Weiter unten sind einige Vorschläge verzeichnet, durch die man das Potenzial für Verletzungen minimiert, wenn Schneidwerkzeuge verwendet werden. Informationen über Produktgefahren und Sicherheitsmaßnahmen, entnehmen sie bitte den allg. Bestimmungen der zuständigen Berufsgenossenschaften.

### **WARNUNG: Sehr heiße Span-Bruchstücke können von den Schneidwerkzeugen abbrechen und mit hoher Geschwindigkeit umherfliegen.**

**Es kann zu Brandwunden, Schnitten oder Einstichen führen. Bitte beachten sie:**

1. Stellen Sie sicher, dass Größe und Form der Wendeschneidplatte für die Werkzeuge und der Gebrauch entsprechend sind.
2. Eine Spankontrolle ist erforderlich, damit die Späne nicht ständig auf das Werkstück fallen.
3. Späne sind sehr heiß und scharfkantig und sollen mit der Hand nicht berührt werden.
4. Schalten Sie immer die Maschine aus, bevor Sie die Späne beseitigen oder die Werkzeuge ändern.
5. Bitte benutzen Sie keine Luftpistole, um die Späne aus der Maschine zu beseitigen.
6. Um ein Werkzeugbruch zu verhindern, setzen Sie bitte das richtige Werkzeug mit richtigen Abmessungen ein.
7. Passen Sie bitte auf die Auskrugung des Werkzeugs auf. Wenn diese zu lang ist, können diese Schwingen und Werkzeugbrüche verursachen.
8. Damit sich das Werkzeug bei der Bearbeitung nicht loslässt, überprüfen Sie bitte, dass das Werkzeug fest genug gespannt wurde.
9. Eine Überarbeit der HM-Werkzeuge kann den Bruch dieser Werkzeuge verursachen.
10. Partikel können sich vom Werkstück mit hoher Geschwindigkeit ablösen.

### **Unsere Werkzeuge dürfen nur Ihrer Bestimmung gemäß verwendet werden**

Um den Maschinenbediener vor möglichen fliegenden Gegenständen zu schützen, die Verletzungen verursachen könnten, sollten die folgenden Sicherheitsmaßnahmen beachtet werden:

1. Halten Sie sich bitte an die allg. Sicherheitsbestimmungen an Maschinen.
2. Tragen Sie Kopfschutz.
3. Tragen Sie Schutzbrille mit integriertem Seitenschutz.
4. Tragen Sie Sicherheitsschuhe.

**WARNUNG: Hartmetall schleifen oder fertigen erzeugt feines Karbid- und Kobalt oder Nickel-Staub. Dieser Staub kann Verletzungen an den Lungen verursachen. Bitte beachten Sie folgende Sicherheitsvorsichtsmaßnahmen, um die Möglichkeit solcher Verletzungen vorzubeugen:**

1. Sorgen Sie für ausreichende Belüftung.
2. Tragen Sie eine Atemschutzmaske (besonders bei schleifen mit Karbid).
3. Verwenden Sie vor dem arbeiten Handschutzcreme und vermeiden Sie längeren Hautkontakt.
4. Kontrollieren Sie bitte die Staub- und Dampf niveaus.
5. Nach der Maschinenbedienung waschen Sie sich bitte die Hände.

### **WARNUNG: Der Gebrauch von Schneidflüssigkeiten und Arbeitsmaterialien schafft Gefahren. Seien Sie zu jeder Zeit sorgfältig.**

1. Schneidflüssigkeiten sollten gewartet werden, da Pilz- Bakterienbefall, Hautkrankheiten verursachen können.
2. Arbeitsmaterialien wie Aluminium, Magnesium, Uran und Titan sind feuergefährlich und könnten in Brand geraten.
3. Schneidflüssigkeiten sind feuergefährlich und könnten bei hohen Temperaturen in Brand geraten.
4. Schneidflüssigkeiten müssen immer sauber sein, damit die Späne das Werkstück nicht beschädigt.

### **WARNUNG:**

Informationen über Geschwindigkeit, Vorschübe und Sorten innerhalb dieses Kataloges sind nur als Hinweis zu benutzen. Wenn der Maschinenbediener sich sicher fühlt, indem er unsere Geschwindigkeiten, Vorschübe und Sorten verwendet, dann sollte Er verwenden, was am bequemsten für ihn oder sie ist. Die Firma Canela ist für Schäden oder Verletzungen nicht verantwortlich, die vorkommen können, wenn man sich nicht an die Informationen hält, die in diesem Katalog beschrieben sind.

**Bedingungen, Fristen und Preise sind Änderungen vorbehalten. Irgendwelcher typografischer oder anderer Fehler in diesem Katalog ist der Korrektur unterworfen.**